

BARNCRAFT®

Wall Planks, Sliding Doors & Hardware



GLASS★CRAFT®
DOOR COMPANY

BARNCRAFT SLIDING DOOR HARDWARE

Premium Hardware Options



SLADE STAINLESS STEEL HARDWARE KIT
BDHA01SSK100 - 100" Rail
BDHA01SSK78 - 78-3/4" Rail



GAGE STAINLESS STEEL HARDWARE KIT
BDHA02SSK100 - 100" Rail
BDHA02SSK78 - 78-3/4" Rail

Single Rollers only

SLADE - stainless steel	#BDHA01SS
GAGE - stainless steel	#BDHA02SS
VINTAGE - black	#BDHA07
SLADE - black	#BDHA01
GAGE - black	#BDHA02
ROYAL - black	#BDHA06
WAGGONER - black	#BDHA03
PHILMONT - black	#BDHA05



SLADE HARDWARE KIT
BDHA01K100 - 100" Rail
BDHA01K78 - 78-3/4" Rail



GAGE HARDWARE KIT
BDHA02K100 - 100" Rail
BDHA02K78 - 78-3/4" Rail



ROYAL HARDWARE KIT
BDHA06K100 - 100" Rail
BDHA06K78 - 78-3/4" Rail



WAGGONER HARDWARE KIT
BDHA03K100 - 100" Rail
BDHA03K78 - 78-3/4" Rail



PHILMONT HARDWARE KIT
BDHA05K100 - 100" Rail
BDHA05K78 - 78-3/4" Rail



VINTAGE* HARDWARE KIT
BDHA07K100 - 100" Rail
BDHA07K78 - 78-3/4" Rail
* (4-7/8" diameter wheels)

IMPORTANT NOTE:

* Vintage rollers have wider diameter of 4-7/8". All others have a 2-3/4" diameter wheel.

** The BarnCraft hardware kits are designed for interior residential doors only. Ensure proper structural support for the rail to the wall for the weight and movement of the door or doors before installation.

Use your cell phone camera
or QRC scan app to **SCAN**
for **More Information**>



HARDWARE KIT PARTS

All Hardware features **ADJUSTABLE RAILS** and **QUIET-GLIDE** wheels

Steel mounting rails include an adjustability feature that allows the rails to be perfectly leveled after installation to the walls. Installation of the rails can be difficult to ensure that the rails are perfectly level. But with this new feature, each rail can be fine-tuned for levelness after the rails have been mounted to the header or directly to the wall. This is an exclusive feature and benefit of BarnCraft sliding door hardware.

Premium Features:

- Rollers glide quietly and smoothly on ball-bearings.
- Made of high quality powder-coated steel in black finish with stainless steel options.
- 2 rail lengths available: Choice of 78-3/4" or 100".
- Weight capacity: 220 lbs.
- Kits include the rollers, rail, stoppers, screws & nuts, anti-jump discs, floor guide and installation guide.
- Rollers are available individually and separately from the kit. See page 8 and refer to the online catalog for more information.

Hardware Kits - Adjustable Leveling Rails

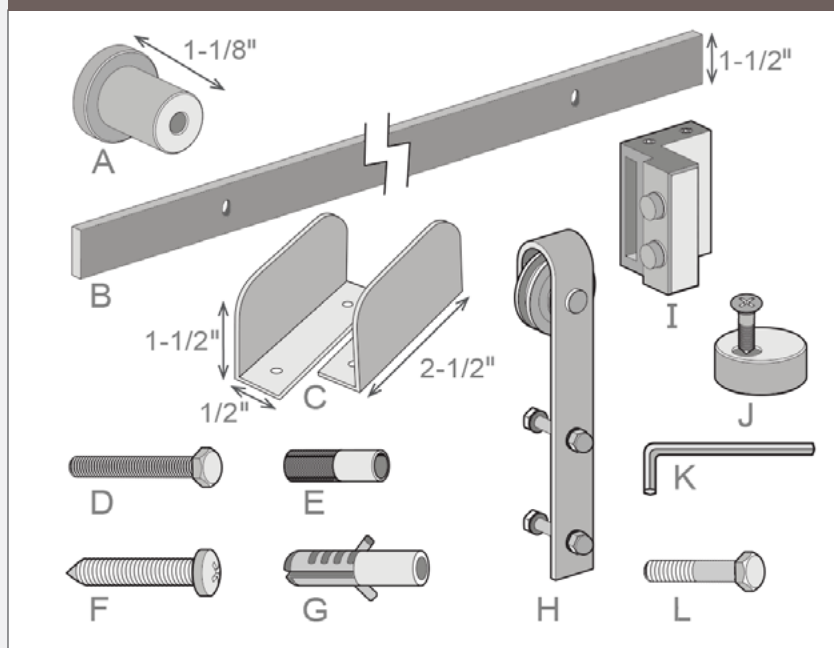

Each **HARDWARE KIT*** includes the following:

- A Stand-off Bracket (x5)
- B Rail (x1) – (see page 10)
- C Floor Door Guide (x1 pair)
- D Bolt (x5)
- E Bolt Wall Anchor (x5)
- F Log Bolt (x5)
- G Log Bolt Wall Anchor (x5)
- H Roller (x2) – (see page 8)
- I Stopper (x2)
- J Anti Jump (x2)
- K Allen Wrench (x1)
- L 45 mm Roller Bolt (x6)
(For use on doors thinner than 1-3/4")

Optional:

See pages 13-15 for optional Locks, Handles, and Wall-mount floor guide.

* See page 8 for complete kit information.

- BDPART1 Includes all screws, 2 Anti Jumps (J), 1 Floor Guide pair (C), for black rollers
- BDPART1SS Includes all screws, 2 Anti Jumps (J), 1 Floor Guide pair (C), for stainless steel rollers
- BDPART2 Includes 2 stoppers (I), and Allen Wrench (K), for black rollers
- BDPART2SS Includes 2 stoppers (I), and Allen Wrench (K), for stainless steel rollers
- BDPARTS3 Includes (6) 45 mm Roller Bolts with washers (L), for black rollers
(For use on doors thinner than 1-3/4")
- BDPARTS3SS Includes (6) 45 mm Roller Bolts with washers (L), for stainless steel rollers
(For use on doors thinner than 1-3/4")



Use your cell phone camera
or QRC scan app to **SCAN**
for **More Information**>

SOFT-CLOSE OPTION FOR SLIDING DOOR HARDWARE

New Improved Soft-Close Option

The Soft-Close option is available for all Sliding Door Hardware Kits.

The soft-close option is an impressive addition to your sliding door installation. Hidden from view, this mechanism ensures a quieter and safer operation of your sliding door by automatically slowing the opening or closing action. No more slamming or jamming issues. Perfect for homes with children, elderly, or those who want ease of use. Packaged 2 per box (one for opening, one for closing), these options attach by set screws directly to the back side of the rail. Consider these product features:

- Allows for a safer and smoother operation of the sliding door by automatically slowing the door as it glides gently and quietly into the closed or open position.
- Helps to prevent slamming and accidental jamming of fingers.
- Reduce noise with silent closing/opening action. Ideal for bedroom, bathroom and office installations.
- Use with any of the 6 Black finished sliding door hardware options on page 8. Available in Black finish only.
- Use one for closing action, and a 2nd to open.



SOFT-CLOSE KIT - BDSC (kit includes all parts needed)

Please visit www.glasscraft.com to view a video of the Soft-Close option in action.

Double Door Rail Connector

Consider installing a Rail Connector with your double doors to seamlessly join 2 rails together, end-to-end. The 2 rails appear as one continuous track for a more polished look. Available in black and stainless steel.



BDRC - Black



BDRCSS - Stainless Steel

Door Rail Options

The metal rail used in the BarnCraft door installation is a very heavy duty solid steel flat bar 1-1/2" in height and 1/4" thick. One rail is needed for every door, so a double door installation needs 2 rails. The rail length depends upon the width of the door. The wider the door, the longer the rail needed.

RAIL LENGTH

78-3/4" Rail

100" Rail

Fits Door Widths

up to 36"

38" to 48"

Black Finish

BDRAIL78

BDRAIL100

Stainless Steel Finish

BDRAIL78SS

BDRAIL100SS

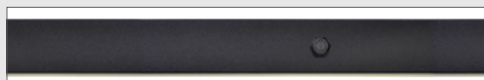

Black Finished Rail

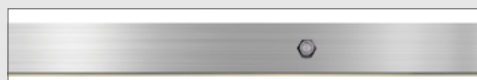

Stainless Steel Finished Rail

Use your cell phone camera
or QRC scan app to **SCAN**
for **More Information**>



HEADER BOARD OPTION FOR BARNCRAFT INSTALLATION

Header Board Options

Installing a Header Board with the BarnCraft hardware kit adds structural support.

The BarnCraft hardware kit is best installed with a header board for added structural support (see examples shown throughout the catalog). With this option, the sliding door hardware is mounted directly to the header board, and the header board mounts to the wall. This method ensures that you can secure this assembly directly into wall studs.

You may use any wood or plywood material for a header board. The Rustic and Barnwood header boards listed below are produced from Knotty Alder and will match your Knotty Alder door. Available finished or unfinished. The White header board option uses a solid wood board with a white thermoformed laminate that can be used white or painted.

RUSTIC KNOTTY ALDER HEADER BOARD OPTIONS				
	80" Length		108" Length	
	1" x 4" x 80"	1" x 8" x 80"	1" x 4" x 108"	1" x 8" x 108"
Stained - Traditional	BDKAS4S-4-80T	BDKAS4S-8-80T	BDKAS4S-4-108T	BDKAS4S-8-108T
Stained - Distressed	BDKAS4S-4-80D	BDKAS4S-8-80D	BDKAS4S-4-108D	BDKAS4S-8-108D
Stained - Antique	BDKAS4S-4-80A	BDKAS4S-8-80A	BDKAS4S-4-108A	BDKAS4S-8-108A
Unfinished	BDKAS4S-4-80	BDKAS4S-8-80	BDKAS4S-4-108	BDKAS4S-8-108
BARNWOOD HEADER BOARD OPTIONS				
Stained Finish	BDKABWS4S-4-80T	BDKABWS4S-8-80T	BDKABWS4S-4-108T	BDKABWS4S-8-108T
Unfinished	BDKABWS4S-4-80	BDKABWS4S-8-80	BDKABWS4S-4-108	BDKABWS4S-8-108
WHITE HEADER BOARD OPTIONS				
Paintable White	BDKAS4S-4-80M	BDKAS4S-8-80M	BDKAS4S-4-108M	BDKAS4S-8-108M

NO HEADER
(edge view)

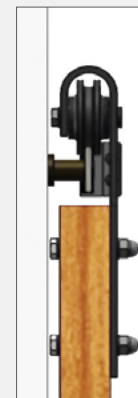

WITH HEADER
(edge view)



Use your cell phone camera
or QRC scan app to **SCAN**
for More Information >



BYPASS OPTION FOR BARNCRAFT INSTALLATION

Bypass Door Option

The Bypass door installation may be used when there is INSUFFICIENT wall space to the right AND/OR the left of the wall opening. A Bypass Installation uses 2 sliding doors and 2 sliding door tracks instead of one. The second door track is cantilevered in front of the first track, so the doors slide in front of and behind each other.

See more about this on page 7. These kits are available in black finish and stainless steel.

For a Double Bypass door installation, you will need 2 doors, 2 sliding door hardware kits plus 1 of these Bypass Rail Bracket Kits (5 brackets per kit). For a Quadruple Bypass door installation (as shown on page 7), you will need 4 doors, 4 sliding door hardware kits, plus 2 of these bypass rail bracket kits.

Bypass Rail Bracket Kit

BDDPRX Black finish (Set of 5 brackets)

BDDPRSSX Stainless Steel finish (Set of 5 brackets)

Note: Vintage Slider Kits are not compatible with the Bypass Bracket Kits.

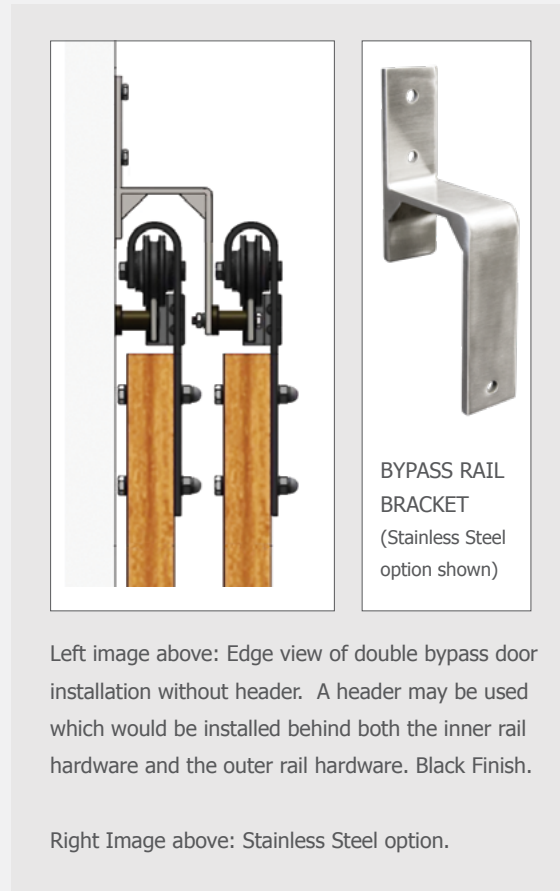

Left image above: Edge view of double bypass door installation without header. A header may be used which would be installed behind both the inner rail hardware and the outer rail hardware. Black Finish.

Right image above: Stainless Steel option.

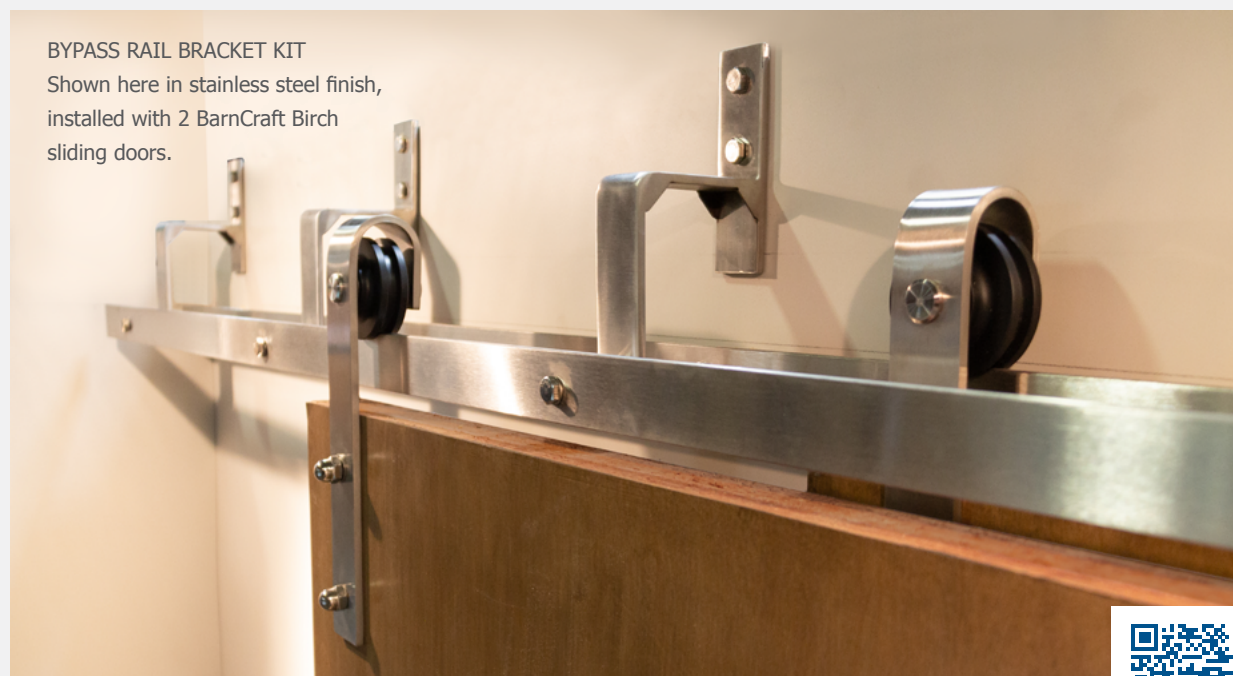

BYPASS RAIL BRACKET KIT
Shown here in stainless steel finish,
installed with 2 BarnCraft Birch
sliding doors.



Use your cell phone camera
or QRC scan app to **SCAN**
for **More Information**>

MORE OPTIONS FOR BARNCRAFT INSTALLATION

Floor / Wall Guide Options

Every BarnCraft hardware kit includes a "Floor Guide" (at near right). Replacements may be purchased individually. The optional Wall-Mounted Guide shown at far right mounts to the wall (not the floor). This guide is an option and not included with the hardware kits. May be used for full size doors, or for small shutter doors, with the wall-mounted floor guide higher on the wall. Both types are adjustable for different door thicknesses.



BDFG
Floor Guide (replacement for kits – sold individually)



BDWM
Wall-Mounted Guide

Privacy Locks

BarnCraft doors may be installed with a locking system for privacy. Specially designed for the BarnCraft Sliding Doors, the privacy lock is made of premium quality steel. Two colors are available: black powder coated steel or stainless steel. Includes all screws and parts required for installation. Boxed individually.

Two sizes are available - Regular and Large. Both will work on all doors, but the Large lock looks and may function better with large doors over 28 square feet. The Regular lock measures about 1.75" x 2.25". The Large lock measures about 3" x 3.25".

Note: GlassCraft will not prep the doors for these locks, as the lock location varies for each specific installation.



BDPL1SS - Regular
Stainless Steel finish

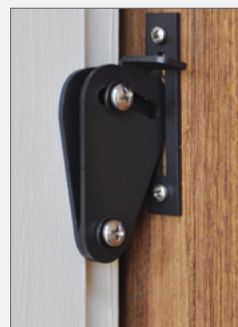

BDPL1 - Regular
Black finish



BDPL2 - Large
Black finish



BDPL2SS - Large
Stainless Steel finish



Use your cell phone camera
or QRC scan app to **SCAN**
for More Information>

BARNCRAFT DOOR HANDLES

Black Pull Handles



Vista (left, 8" tall) - HP4
Prospect (right, 8" tall) - HP26

The black handles shown on this page are made of real handwrought iron that is durable, heavy, and complements any design theme, together with your choice of BarnCraft door and sliding hardware. As these handles are all hand-made, their size and appearance will vary slightly. All are packaged with mounting screws.

The VISTA mounts flush with the face of the door, and requires a mortise pocket be cut or chiseled into the door for installation. The PROSPECT is 1/4" thick, and mounts directly on the door face, and does not require a mortise pocket. The other handles shown below extend above the face of the door, and can only be mounted on the door face away from the wall. The Vista or Prospect may be mounted on the "back" side of the door. The 12" pull handles directly below are designed to be mounted with the Vista or the Prospect on the "back" side of the door, as the screw holes for each align, but they also may be used separately (without Vista or Prospect).

Refer to our BarnCraft Product & Information Guide for more detail.

12" Pull Handles for 8" Vista or Prospect plate mount

The 5 pull handles at right may be used with or without the Vista pull or Prospect plate, with the 12" handle on the front of the door, and the Vista or Prospect on the back side.



Vista - HP4
(8" tall)
shown with
Metro pull

Prospect - HP26
(8" tall)
shown with
Metro pull

24" Pull Handles



Tucson
HP1324

San Juan
HP1624

Gila
HP1724



Tucson
HP13

San Juan
HP16

Gila
HP17

Santa Fe
HP1

Monterey
HP2

Corona
HP3

12" Pull Handles

The 6 pull handles below and the 3 to the left all screw directly into the front face of the door.



Use your cell phone camera
or QRC scan app to **SCAN**
for **More Information**>

BARNCRAFT DOOR HANDLES

Stainless Steel Pull Handles



Vista (Right) (8" tall) - HP4S
Prospect (Left) 8" tall) - HP26S

The stainless steel handles shown on this page and throughout this catalog are made of real stainless steel. As these handles are all hand-made, their size and appearance will vary slightly. All are packaged with mounting screws.

The VISTA pull (shown at near left) and the PROSPECT pull (far left) mount on the face of the door. The Vista requires a mortise pocket be machined or chiseled into the door. The PROSPECT is 1/4" thick, and mounts directly on the door face, and does not require a mortise pocket. The Metro handles extend above the face of the door, and can only be mounted on the door face away from the wall. The Vista or Prospect may be mounted on the "back" side of the door. The Metro is mounted with screws from the back side of the door, which will be visible on the back side.

The 12" and 16" Metro pull handles are designed to be mounted with the VISTA or the PROSPECT on the "back" side, as the screw holes for each align, but they also may be used separately (without the Vista or Prospect).

Refer to our BarnCraft Product & Information Guide for additional specifications and information.



Metro Stainless Steel:
Available in 12", 16", 48", or 60" tall.
The 12" and 16"
will fit the Vista
pull to mount
together, or they
may be used
separately.



 <p>Metro - HP20S (12" tall) Stainless Steel</p> <p>Diameter: 3/4" Total Length: 12" Projection: 3"</p> <p>will fit VISTA pull.</p>	 <p>Metro - HP48S (48" tall) Stainless Steel</p> <p>Diameter: 1-1/4" Total Length: 48" Center to Center Door Mounting Distance: 30" Projection: 3"</p>	 <p>Metro - HP60S (60" tall) Stainless Steel</p> <p>Diameter: 1-1/4" Total Length: 60" Center to Center Door Mounting Distance: 48" Projection: 3"</p>
 <p>Metro - HP21S (16" tall) Stainless Steel</p> <p>Diameter: 3/4" Total Length: 16" Projection: 3"</p> <p>will fit VISTA pull.</p>		



Use your cell phone camera
or QRC scan app to **SCAN**
for **More Information**>

ADDITIONAL INFORMATION

Warranty

The BarnCraft Collection is backed by our guarantee of craftsmanship and premium quality. GlassCraft offers a limited 1 Year door warranty on all BarnCraft sliding doors.

GlassCraft also provides its BarnCraft hardware with a guarantee of durability. Produced with strong steel and quiet-gliding operation, the BarnCraft sliding door hardware comes with a limited 5 Year warranty.

Visit www.glasscraft.com for more information.

BarnCraft Door Dimensions

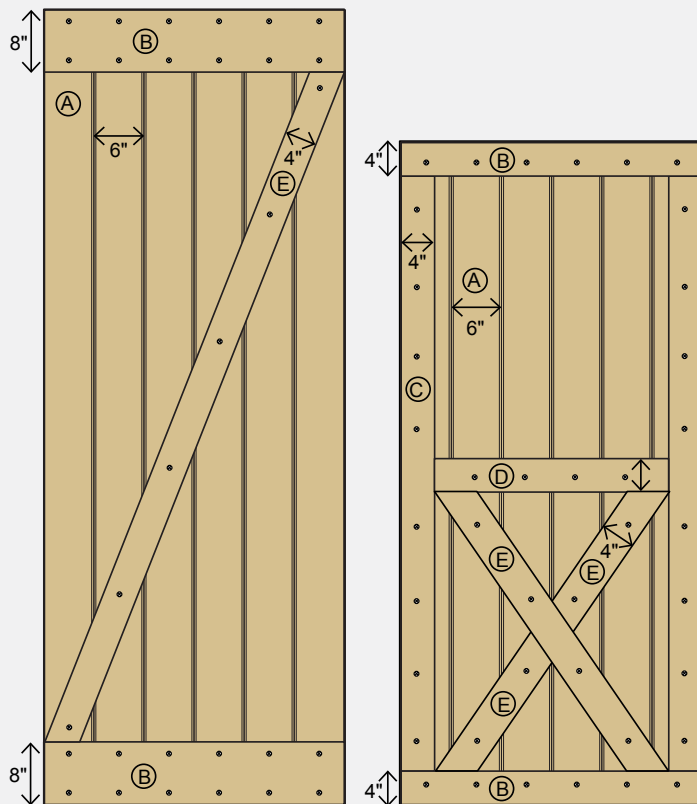

PLANK DOOR
Shown here with 8'0" tall
Z Barn Door

PANEL DOOR
Shown here with 6'8" tall
X Two Panel Barn Door

- A – Tongue-and-groove Plank 6" width
- B – Cross Rail 8" height (Plank style doors only)
4" height (Panel style doors)
- C – Vertical Brace 4" width (Panel style doors only)
- D – Horizontal Brace 4" height (Panel style doors only)
- E – Diagonal Brace 4" width



FAQs:

- 1) **What is the thickness of the Barn Doors?**
3/4" thick doors + 1" thick rails for a total door thickness of 1-3/4" for the Pine or Knotty Alder Barn Door series. Other door series vary in door thickness. Check corresponding section pages.
- 2) **How do we determine which track length is needed?** We recommend the 78-3/4" track for door width of up to 36". For door widths of 38" up to 48" wide we suggest the 100" rail length. Double doors or by-pass doors require more than 1 rail.
- 3) **Will the Hardware work with other doors that GlassCraft offers?** Yes. Visit www.glasscraft.com to view other doors.
- 4) **Is the hardware all metal and are the rollers Nylon?** The wheel part of the rollers are a Nylon material which provides the Quiet-Glide benefit. All other parts are powder-coated solid metal. Wheel axles include ball-bearings.
- 5) **What does the back of the barn door look like?** The Pine or Knotty Alder Barn Door series are constructed from planks of Pine or Knotty Alder wood or Knotty Alder Barn Wood. The back side will be stained or painted in the same finish as the front. If the doors come with rails or braces, these pieces will be on the front side where the rollers are facing. The MDF door series is available with the Design on 1 side only, or both sides.
- 6) **What are the dimensions of the knotty alder barn doors?** See the diagrams at left. Other door series have different dimensions. The Iron plank doors all use 6" planks. The MDF doors, birch doors, and Mahogany doors all vary according to door width, height, and design.

WOODCRAFT

Knotty Alder and Mahogany Entry Doors

New

ANTIQUÉ
GLASS TEXTURE

GLASS★CRAFT®
DOOR COMPANY

DECORATIVE IRON DOOR STRAPS & CLAVOS

Decorative Clavos Series

Decorative "clavos" or door nails can be mounted on the face of a door to give it a rustic or antique look. They can be mounted on the interior or exterior or both sides of a door*, and they may be used with or without the door straps shown at right. Because these are hand-cast and handmade, they will vary slightly in appearance.



Wrought Iron Straps Series

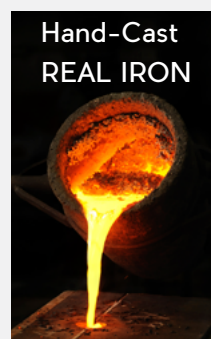
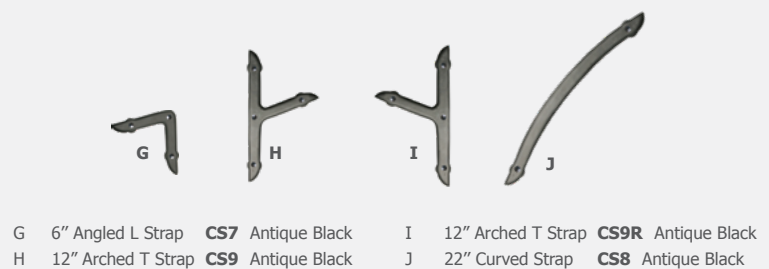
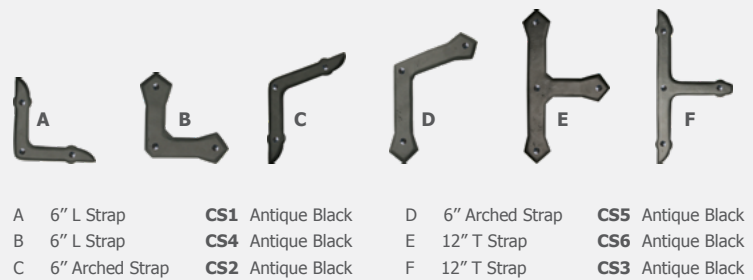

*NOTE: Manufacturer mounts clavos & straps to the exterior of the door only in the factory. If they are ordered for the interior of the door, items will be sent separately to be mounted by the customer.

Use your cell phone camera or QRC scan app to **SCAN** for More Information >



PRE-HUNG OPTION & ADVANTAGES

PRE-HUNG ENTRYWAYS WITH CONTINUOUS SILL



PRE-HUNG OPTION

All doors in this catalog may be ordered as pre-hung door units. Part numbers & images for pre-hung door options are available in our on-line catalog – refer to page 2 for info on how to access this information.

All entryway configurations available for hardwood doors include “continuous” one-piece sills. This means that the bottom sill or threshold is made from one continuous piece of threshold material, which adds strength and prevents leaking under the entryway. This assembly design is especially important in configurations that include 1 or 2 sidelites. Other manufacturers may produce this entry configuration using a “boxed” construction method with separate sills for each sidelite.

GlassCraft uses a 1-piece sill construction method for reinforced strength and enhanced appearance.

Doors shown at left are Portobello Mahogany 3’0” x 8’0” double doors with Flemish privacy glass. See page 30.

PRE-HUNG COMPONENTS

Standard Pre-hung entryways include the following:

- 4-9/16” Jamb Legs
- Header
- Standard Sill
- Anti-Rot Sill End Caps
- Ball-Bearing Hinges
- Weatherstrip
- T-Astragal (where applicable)
- Flush Bolt (where applicable)
- Mull Posts (where applicable)

Optional Pre-hung components at extra charge:

- 6-9/16” Jamb
- Custom Jamb Widths up to 10” wide
- Brick Mold
- Sub-Casing
- Interior Casing
- Endura Sill
- Door Sweep
- Door Bore
- Strikejamb Reinforcement

Use your cell phone camera
or QRC scan app to **SCAN**
for **More Information**>



DOOR FRAME AND HINGE OPTIONS

Hardwood Door Frames with STRIKEJAMB™

Mahogany and Knotty Alder pre-hung doors are available with a steel-reinforcement StrikeJamb™ as an option.

Pre-hung units include jamb legs, T-astragal (for double doors), standard sill, header, weatherstripping, and adjustable threshold, plus 3 ball-bearing hinges on 6'-8" tall doors and 4 ball-bearing hinges on 8'-0" tall doors.

The StrikeJamb™ reinforcement can be installed on the lock side jamb leg for safety and security. This plate reinforces the jamb leg, and allows the deadbolt and the handleset bolt to throw so that the bolts extend through the corresponding holes in the steel reinforcement plates. In addition, long mounting screws should be used with this StrikeJamb, these screws extending through the jamb leg, then through the steel plate, and finally into the wall studs.

Image at right shows the reinforcing plate from the back jamb leg side.



Hinge Color Options

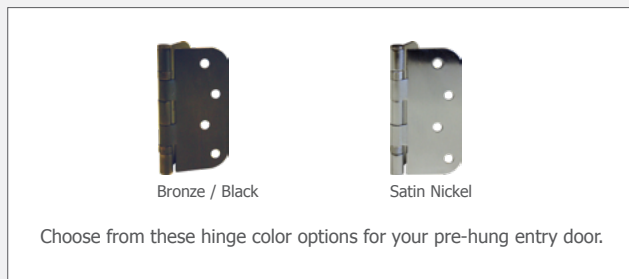

All pre-hung units use 3 ball-bearing hinges on 6'8" tall doors and 4 hinges on 8'0" tall doors. 1-3/4" thick doors use 4" hinges. Choose from the two hinge color options shown at left for your pre-hung entry door unit: Bronze / Black, or Satin Nickel.

Construction Door Options

All standard pre-hung entryways in all configurations are available with a temporary "construction door" as an option. Using this temporary door, the permanent door will not be damaged during house construction. Construction doors are available for double-door and arch top and round top double doors also. Both hollow core and solid core construction doors are available.

Construction Door Part Numbers:

TEMPDOOR1 - Hollow Core 3'0" x 6'8" x 1-3/4"
TEMPDOOR5 - Hollow Core 2'8" x 6'8" x 1-3/4"
TEMPDOOR10 - Solid Core 3'0" x 6'8" x 1-3/4"

TEMPDOOR2 - Hollow Core 3'0" x 8'0" x 1-3/4"
TEMPDOOR4 - Hollow Core 2'8" x 8'0" x 1-3/4"
TEMPDOOR7 - Hollow Core 3'6" x 8'0" x 1-3/4"
TEMPDOOR9 - Solid Core 3'0" x 8'0" x 1-3/4"

JAMB LEG & SILL OPTIONS

Jamb Leg and Mull Post Rot Protection Included

GlassCraft entryways utilize our unique protective threshold end caps, which are hard rigid plastic parts machined to perfectly match the profile on the bottom edge of a jamb leg. We also use mull post caps at the bottom of all mull posts which are positioned between doors and sidelights. This method of assembly inhibits the hardwood jamb legs and mull posts from rotting over time due to the absorption of water up from the bottom edge of the entryway.

- | | | | |
|---|-------------------|---|------------------------------|
| 1 | Door | 4 | Door Sweep |
| 2 | Door Weatherstrip | 5 | Door Sill |
| 3 | Hardwood Jamb Leg | 6 | Hard Plastic Jamb Leg Bottom |

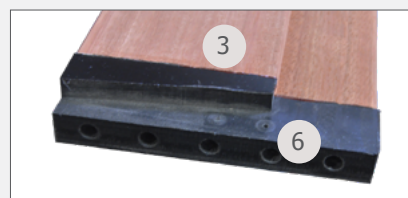
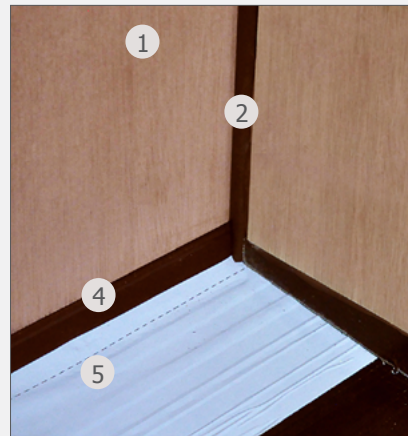

Images show the bottom corner of door (1), sill (5) and jamb leg (3) (6).

Sill and Sill Color Options

All standard pre-hung exterior door units use adjustable composite sills that help prevent water penetration, rotting, warping, and discoloration. Our standard adjustable composite sill includes a peel-off film which protects the sill during construction, and is made from 100% composite materials. The "adjustable" feature allows the top of the sill to be adjusted with a screwdriver to match the correct height required for the bottom of the door. Optionally, you may select the Endura® Brand adjustable composite threshold (for an extra charge) that is made from composite and aluminum material or an ADA aluminum threshold. The ADA threshold is approved for use with wheelchairs. ADA sills are 5" x 1/2" or 7" x 1/2". The Endura Z-Series sill system provides a walnut colored sill cap, the adjustable feature, and a hard plastic, protective construction cover.

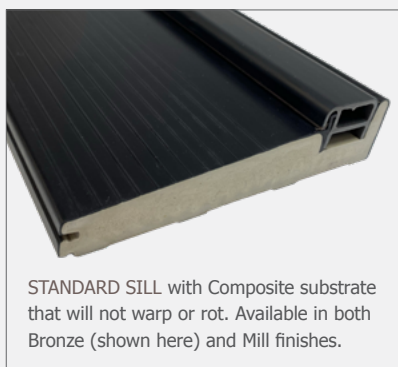
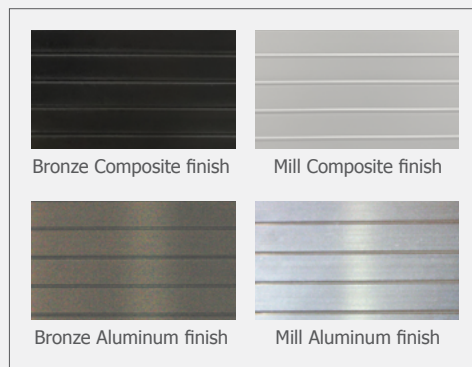

STANDARD SILL with Composite substrate that will not warp or rot. Available in both Bronze (shown here) and Mill finishes.



OPTIONAL ENDURA brand threshold is available in Bronze Aluminum and Mill Aluminum (shown here) finishes, and includes a removable hard protective construction cover.

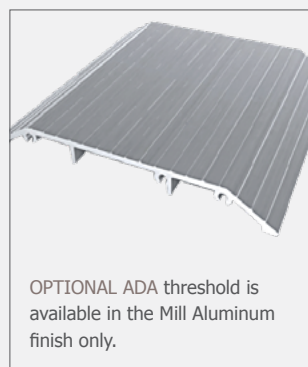

OPTIONAL ADA threshold is available in the Mill Aluminum finish only.

BUFFALO FORGE[®] brand CAST BRONZE & BRASS ENTRYSETS

Single or Multipoint Hardware features Cast Bronze or Forged Brass Handle Set & Lock Options

Our BUFFALO FORGE brand lock sets are produced by hand-made processes utilizing molten sand-cast bronze or forged brass, and feature solid construction and precision engineered lock mechanisms. These are large lock sets with long escutcheon trim plates and they give a very heavy and strong, secure feel. Excellent design and style, with several models available for different door designs. This hardware has the look and feel of hardware costing three times the price. All use a standard Y1 Keyway. Two keys are provided. 2-3/8" backset.

All of the lock sets shown on the following two pages are available with standard 2-point models (latch and deadbolt), or with a multipoint deadbolt. All lock sets are available with matching "dummy" lock sets, which are used for double-door installations. These dummy lock sets do not have any internal mechanism, no key hole, and no thumb latch and are mounted on the "inactive" door, with two-point or multipoint lock sets used on the "active" door. See example photo on page 14 of Dummy Set.

All lock sets shown may be used for right-hand or left-hand door swings and all hardware necessary is included for either installation including 2 lever latches. Installation into the door slab and jamb is included in the price of all of these standard and multipoint lock sets. All Buffalo Forge entrysets will fit all full-sized doors in this catalog.

- Each Buffalo Forge lock set is available in 2 of 4 colors: Dark Bronze or Oil Rubbed Bronze and Satin Nickel or Antique Nickel.
- Included with these Buffalo Forge lock sets are the lock cylinder, deadbolt, matching screws and face plate(s).



Buffalo Forge Multipoint Option

An excellent option for all Buffalo Forge handle set models on the next 2 pages is our multipoint deadbolt.

It functions exactly the same as any deadbolt, making this very intuitive and easy to operate. Instead of just 1 deadbolt, we offer this option that provides TWO deadbolts, adding a significant amount of security and strength to your entry door. In addition, this creates a tighter weather-seal, and helps to prevent against door warpage.

- 18-1/2" spacing between deadbolts
- Face plate is approx 24" long x 5/8" wide
- 1" deadbolt throw
- Stainless steel construction of mechanism
- Bronze cover plate and strike plates

This option will work on any handleset shown on the next two pages. Installation into the door slab and jamb is included in the price.

Door shown above is a 6'8" Craftsman Mahogany 4-Lite, 2-Panel door with Rustic Arch handle and multipoint option.



casting the escutcheon plate

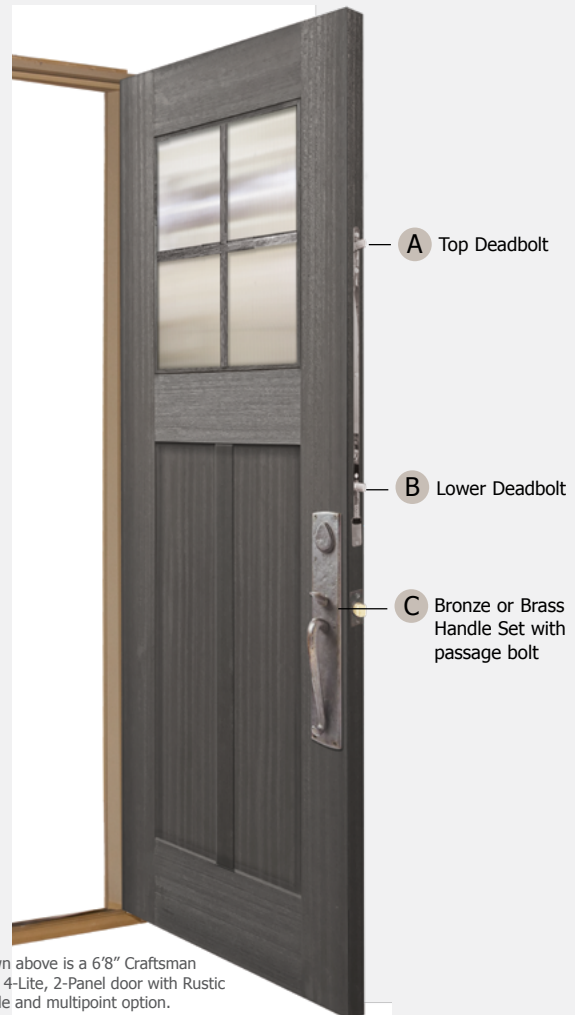

BUFFALO FORGE® CAST BRONZE & BRASS ENTRYSETS - LEVER LATCH

Features & Benefits

- Six designs, each in 2 colors
- Made of sandcast bronze or forged brass
- 5-1/2" center-to-center boring
- Single cylinder function only
- Requires standard 2-1/8" diameter borings
- 2-3/8" backset
- Fits doors with thickness of 1-3/4"
- Swinging key flap on exterior plate
- Includes all operating parts and fastening hardware
- Left or right handing
- Dummy Sets available for each
- Dummy hardware does not include thumb latch or key flap
- Knobs available for interior to replace levers (see next page)

Rustic Fleur DARK BRONZE

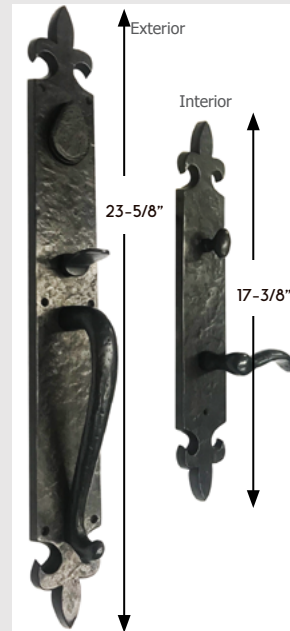

Rustic Fleur ANTIQUÉ NICKEL

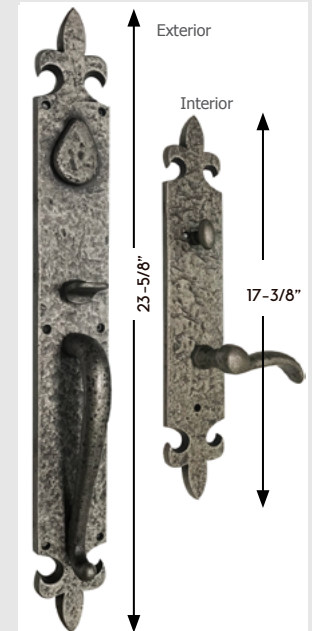

Sandcast Bronze Handleset

2 colors – Antique Nickel and Dark Bronze / Dummy Set available
Trim Plate Size: Exterior: 23-5/8" x 3"
Interior: 17-3/8" x 3"

Arch DARK BRONZE

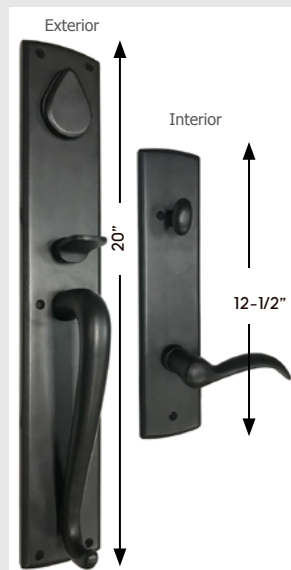

Arch ANTIQUÉ NICKEL

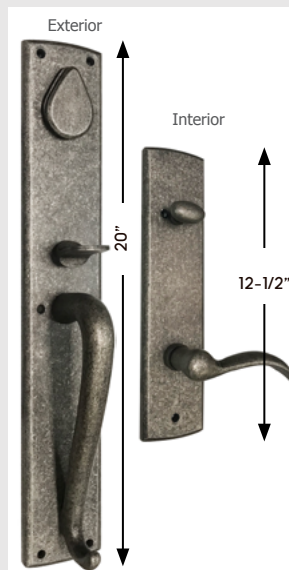

Sandcast Bronze Handleset

2 colors – Antique Nickel and Dark Bronze
Dummy Set available
Trim Plate Size: Exterior: 20" x 3"
Interior: 12-1/2" x 2-1/2"

Rustic Arch DARK BRONZE

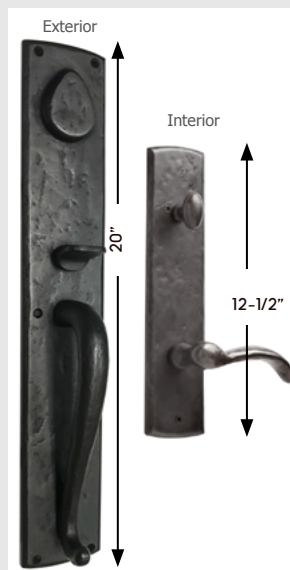

Rustic Arch ANTIQUÉ NICKEL

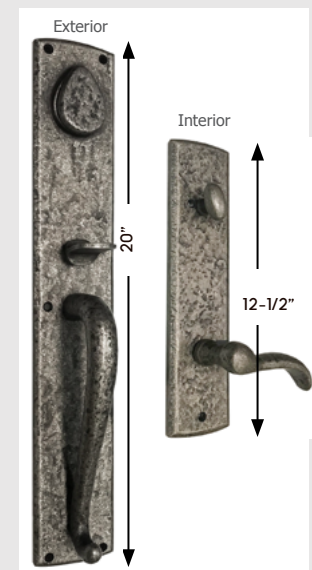

Sandcast Bronze Handleset

2 colors – Antique Nickel and Dark Bronze
Dummy Set available
Trim Plate Size: Exterior: 20" x 3"
Interior: 12-1/2" x 2-1/2"

Use your cell phone camera
or QRC scan app to **SCAN**
for **More Information**>



BUFFALO FORGE® CAST BRONZE & BRASS ENTRYSETS - LEVER LATCH

Stepped Arch OIL RUBBED BRONZE

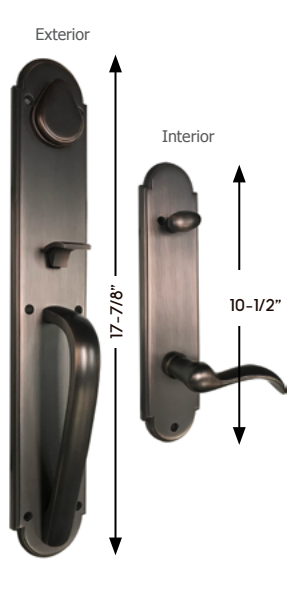

Stepped Arch ANTIQUE NICKEL

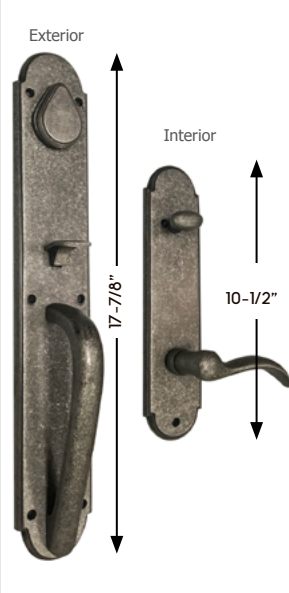

Sandcast Bronze Handleset

2 colors – Antique Nickel and Oil Rubbed Bronze
Dummy Set available
Trim Plate Size: Exterior: 17-7/8" x 3"
Interior: 10-1/2" x 2-7/16"

Rectangular OIL RUBBED BRONZE

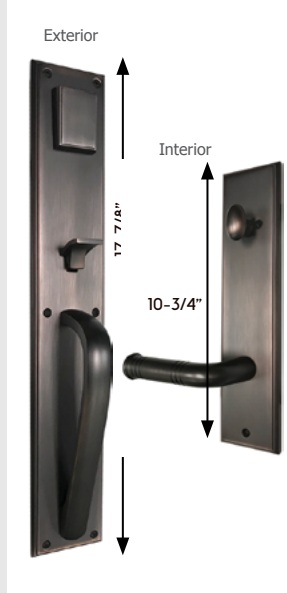

Forged Brass Handleset

2 colors – Satin Nickel and ORB
Dummy Set available
Trim Plate Size: Exterior: 17-7/8" x 3"
Interior: 10-3/4" x 2-7/16"

Rectangular SATIN NICKEL

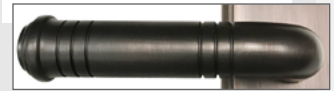

Detail photo of Rectangular lever

Contemporary OIL RUBBED BRONZE



Contemporary SATIN NICKEL

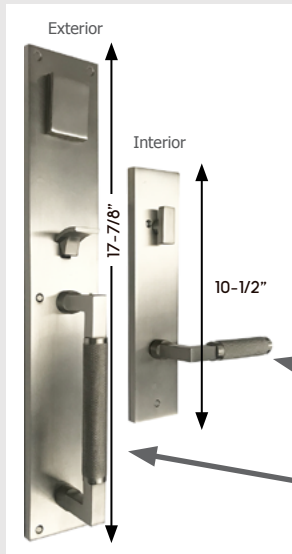

Forged Brass Handleset

(handle texture detail at left)
2 colors – Satin Nickel and Oil Rubbed Bronze
Dummy Set available
Trim Plate Size: Exterior: 17-7/8" x 3"
Interior: 10-1/2" x 2-7/16"

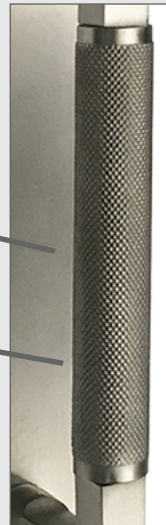

Detail of texture on Contemporary handle and lever



All Buffalo Forge hardware have non-operable Dummy Sets available for inactive doors with no key flap and no thumb latch. Contemporary ORB dummy shown above.



Use your cell phone camera or QRC scan app to **SCAN** for More Information>

ROCKWELL brand CAST BRASS ENTRYSETS

Single or Multipoint Lock Sets Add Security - Forged Brass Handle Set & Lock Options

These lock sets are produced by the traditional drop-forged process utilizing solid brass, and featuring heavy gauge construction, a precision engineered mechanism, and superior corrosion protection. All use a standard 5 pin SCI Keyway. Wide bow keys are provided. 2-3/8" backset only.

All of the lock sets shown on the next two pages are compatible with the multipoint lock systems shown below. In addition, the **Windsor**, **Savoy**, and **San Jose** are also available as "one-point" traditional lock sets for both 6'8" and 8'0" tall doors. And all lock sets are available as "dummy" lock sets, which are used for double-door installations. These dummy lock sets do not have any internal mechanisms and are mounted on the "inactive" door, with one-point or multipoint lock sets used on the "active" door.

The **Sapphire** multipoint and dummy lock sets are also available with a special "PVD" coating on the handle set and stainless steel for the multipoint mechanism for use in coastal installation applications. These are noted as "Coastal" in the item descriptions. This PVD Physical Vapor Deposition coating is harder, more resistant to corrosion and abrasion, and provides a longer-lasting coating when used in coastal areas.

All lock sets shown may be used for right-hand or left-hand door swings and all hardware necessary is included. Installation into the door slab is included in the pricing of all of these one-point and multipoint lock sets.

Rockwell Multipoint Option

Increase security and peace of mind with Rockwell's multipoint lock option with deadlocking tongues built to work with traditional grip hardware. Choose from any of the multipoint handle set trim options shown on the next 2 pages. This multipoint system is activated with the turning of the deadbolt lock. All 3 locking points are engaged only when the deadbolt point is locked by turning the thumb latch.

This multipoint lock set includes an anti-saw and kick-proof center deadbolt for maximum security and a 90-degree consumer friendly locking operation, so you visually know the door is locked when the deadbolt knob is in the horizontal position. In addition, these multipoint assemblies are produced using heavy-gauge steel with a zinc dichromate finish per ATSM-8633 testing standard. Stainless steel models are available for both 6'8" and 8'0" sizes for coastal installation.

Multipoint lock systems use our standard flush bolts installed on the passive door of a pre-hung double door, which gives the homeowner the option to include dummy handle sets on the passive door with all multipoint lock sets.

Precision-engineered components reduce the need for service calls, providing years of trouble-free service. These multipoint assemblies have been cycle-tested to exceed 300,000 locking cycles. Adjustable strike plates allow for field adjustment during and after installation. The design of these multipoint systems allows for right hand or left hand installation with the same part.

GlassCraft provides installation of the 3-point lock mechanism into the door, and installation charges are included in the cost of these lock sets. Installation involves precision machining of the edge of the door slab, which is performed with CNC machines to ensure precision.

When ordering for double doors, only 1 multipoint lock set is required. You may choose to include a "dummy" handle set on the inactive door for appearance purposes.



Door shown above is a 6'8" Arch Lite New Orleans decorative glass and multipoint Windsor lock set.

ROCKWELL CAST BRASS ENTRYSETS - LEVER LATCH

Features & Benefits

- Solid brass, heavy gauge construction with precision-engineered mechanism
- Compatible with multipoint lock system (page 15)
- Available with one-point lock sets for 6'8" and 8'0" doors (for Windsor, Savoy, and San Jose)
- Dummy lock sets available for inactive door in a double door entryway (no internal mechanism).
- Special PVD coating option on multipoint and dummy locksets (for Satin Nickel Sapphire)

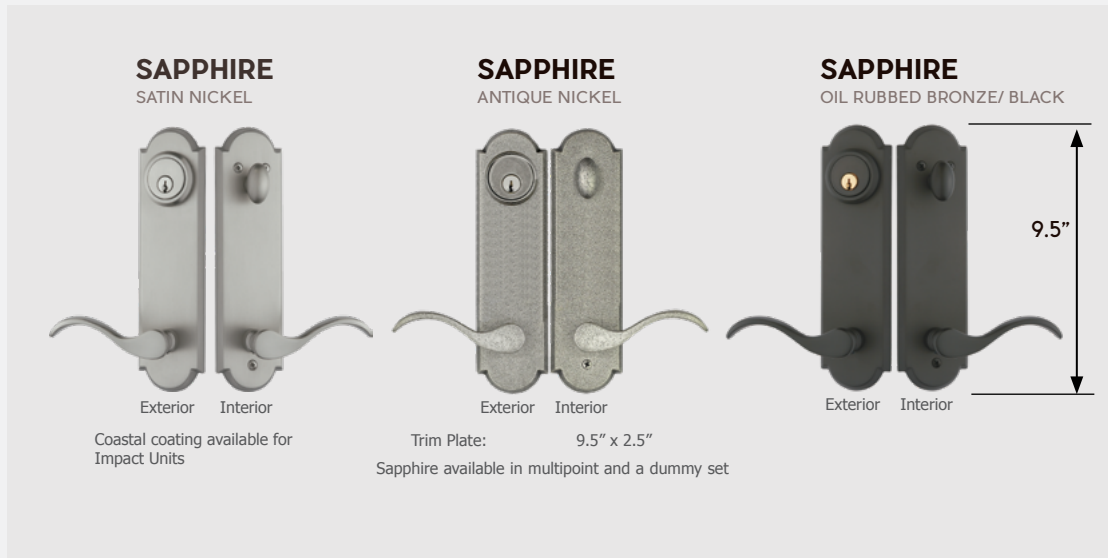

Use your cell phone camera or QRC scan app to **SCAN for More Information**

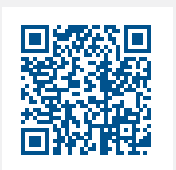

ROCKWELL CAST BRASS ENTRYSETS - THUMB LATCH

SAVOY
SATIN NICKEL

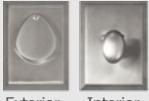

Exterior Interior



17.0" nominal

Savoyn available in multipoint or a 2-point and a dummy set

SAVOY
ANTIQUENICKEL



Exterior Interior



SAVOY
ORB / BLACK



Exterior Interior



Trim Plate (top): 3.875" x 2.75"
Trim Plate (middle): 5" x 2.75"
Trim Plate (bottom): 3.875" x 2.75"

ZENIA
SATIN NICKEL

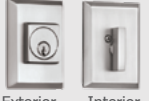

Exterior Interior



17.5" nominal

Zenia available in multipoint and a dummy set

ZENIA
ORB/BLACK

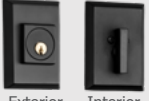

Exterior Interior



Trim Plate (deadbolt): 3.94" x 2.75"
Trim Plate (top): 5" x 2.75"
Trim Plate (bottom): 3.94" x 2.75"
Total nominal height: 17.5"

WINDSOR
SATIN NICKEL



Exterior Interior



16.25" nominal

Windsor available in multipoint or a 2-point and a dummy set

WINDSOR
ANTIQUENICKEL



Exterior Interior



WINDSOR
ORB/BLACK

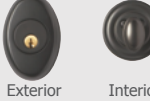

Exterior Interior



Trim Plate (top): 3.5" x 2.375"
Trim Plate (middle): 4.25" x 2.75"
Trim Plate (bottom): 2.25" x 1.5"

CARMEL
SATIN NICKEL



Exterior Interior



18.375"

Carmel available in multipoint and a dummy set

CARMEL
ORB / BLACK



Exterior Interior



Trim Plate: 18.375" x 2.5"

SAN JOSE
ANTIQUENICKEL

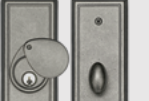

Exterior Interior

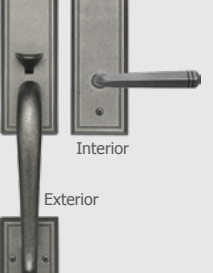

18.25"

San Jose available in multipoint or 2-point and a dummy set

SAN JOSE
ORB / BLACK



Exterior Interior

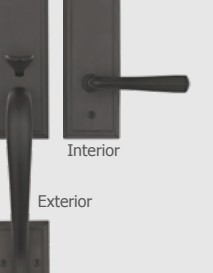

Trim Plate (top): 11.125" x 2.5"
Trim Plate (bottom): 3.5" x 2.5"

LUMINA
SATIN NICKEL



Exterior Interior



18.375"

Lumina available in multipoint and a dummy set

LUMINA
ORB / BLACK



Exterior Interior



Trim Plate: 18.375" x 2.5"

Use your cell phone camera or QRC scan app to **SCAN** for **More Information**



The WOODCRAFT COLLECTION SOLID & PLANK DOORS

Speakeasy Grille Options

Most of our solid panel doors shown in this section may be ordered with our "speakeasy" option installed (see photo below). With this option, a small, operable rectangular door is installed in the upper door panel at a height of approximately 5'-6" (speakeasies are installed lower on round top double doors). This small door is hinged and latched from the interior side of the door. The speakeasies are available in 4 wrought iron grille designs.



WR16 Florentine



WR15 Madrid



WR105 Star

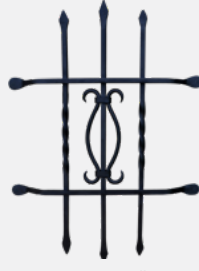

WR103 Seville



Close-up photo of speakeasy on a Knotty Alder door with Florentine grille, finished in black.

Speakeasy Glass Options

Choose from 6 different glass texture options to complement your wrought iron and hardwood entry door. All glass textures shown below are produced using a double IG (insulated glass) unit to provide safety, security, and energy efficiency. The capacity to see through the glass panel varies depending upon the glass texture chosen. The Water texture option offers a light obscured view or level of privacy. Flemish and Reeds glass options offer a moderate level of obscured view. Rain and Ocean give the highest level of privacy.



CLEAR

1 - PRIVACY RATING



WATER

3 - PRIVACY RATING

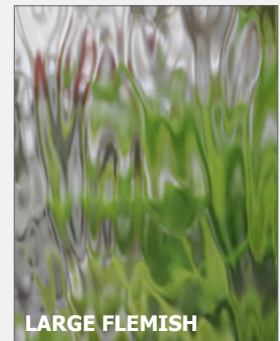

LARGE FLEMISH

5 - PRIVACY RATING



REEDS

7 - PRIVACY RATING



OCEAN

8 - PRIVACY RATING



RAIN

9 - PRIVACY RATING

FIBERCRAFT®

Premium & Pro Composite Entry Doors



SELECT PREMIUM
SERIES DOORS USE:



GLASS★CRAFT®
DOOR COMPANY

PRE-HUNG OPTION & ADVANTAGES

Pre-hung All-Composite Entryways with Continuous Sill



Pre-hang Option

GlassCraft doors in this catalog can be ordered as pre-hung door units. Drawings and part numbers for available configurations of pre-hung doors are shown via our online catalog.

Most entryway configurations (except Impact rated units) available for FiberCraft doors include “continuous” one-piece sills. This means that the bottom sill or threshold is made from one continuous piece of threshold material which adds strength and prevents leaking under the entryway. This assembly design is especially important with configurations that include 1 or 2 sidelites. Impact rated pre-hung options use a “boxed” construction method with separate sills for each sidelite.

GlassCraft uses a 1-piece continuous sill construction method for reinforced strength and enhanced appearance.

Pre-hung Components

Standard Pre-hung entryways include the following:

- 4-9/16” Jamb Legs
- Header
- Standard Sill
- Hinges
- Weatherstrip
- T-Astragal (where applicable)
- Flush Bolt (where applicable)
- Mull Posts (where applicable)

Optional Pre-hung components at extra charge:

- 6-9/16” Jamb Legs
- Brick Mold
- Endura Sill
- Door Sweep
- Door Bore
- Strikejamb Reinforcement
- Multipoint Hardware
- Construction Doors

Use your cell phone camera
or QRC scan app to **SCAN**
for Pricing & Info>



FIBERCRAFT® PRE-HUNG DOOR OPTIONS

Composite Sidelite Options for Pre-hung Units

All Fiberglass Composite Doors in this catalog can be ordered as a pre-hung door unit with one or two sidelites. Many door designs have specific matching sidelites. Look for the "sidelites" notation at the bottom of the door photo.

In addition to the matching sidelite designs mentioned above, most doors may be ordered with one or two "Full Lite" sidelites. Full lite sidelites for 6'8" tall doors include a glass panel that is 64" tall x 8" wide. Full lite sidelites for 8'0" tall doors include a glass panel that is 80" tall x 8" wide. (Visible glass is 1 inch less than these measurements). Both sizes available with a wood grain or smooth texture and in all glass textures.

In addition to the matching sidelite designs mentioned above, most doors may be ordered with one or two "Full Lite" sidelites. Full Lite sidelites for 6'8" tall doors include a glass panel that is 64" tall x 8" wide. Full Lite sidelites for 8'0" tall doors include a glass panel that is 80" tall x 8" wide. (Visible glass is 1 inch less than these measurements). Both sizes are available with a wood grain or smooth texture and in all glass textures.



6-8 Sidelite 64" frame uses fiberglass construction. 8-0 Sidelite 80" frame uses wood construction.



Many doors offer matching sidelite designs, such as this matching SDL sidelite above. All doors in this catalog are available with "Full Lite" sidelites as shown at left.

Composite Transom Options for Pre-hung Units

Matching Transoms are available with the Grille-Between-Glass, Simulated Divided Lite, and Clear & Privacy glass options. Look for the "sidelites & transoms" notation at the bottom of the door photo. Transoms are available in direct-set configurations only (no sash around the glass). Each transom is available in varying widths, depending upon the door or door and sidelite configuration below the transom. Transoms are made with an all-composite, no-rot material and can be stained or painted. Refer to our online product guide for more information.

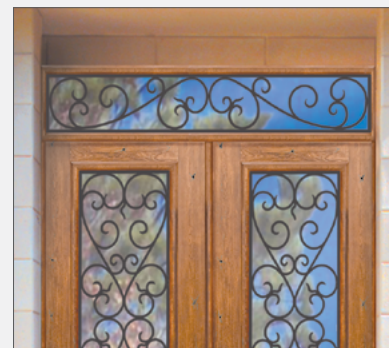

All-Composite Components

All GlassCraft Fiberglass Composite Doors in this catalog can be ordered as a pre-hung door unit. Configuration drawings and pricing for pre-hung doors are available via our online catalog. GlassCraft uses our exclusive all-composite material in all FiberCraft pre-hung entryways. This WPC (wood polymer composite) material resists decay and rot, is impervious to weather, and will not crack or split like wood jamb legs. All jamb legs, headers, brick mold and sills utilize composite materials and no wood parts are used in the pre-hang components.

When ordered as a pre-hung unit, doors with a wood grain include wood-grain components. Smooth doors include jamb components without a wood grain.

Standard pre-hung units include 4-9/16" wide jamb legs, jamb header, adjustable threshold, weatherstripping, plus 3 ball-bearing hinges on 6'8" tall doors and 4 ball-bearing hinges on 8'0" tall doors, brick mold, plus T-astragal (for double doors), and mull post and flush bolts (where needed and applicable). Pre-hung unit options include door sweep, brick mold, 6-9/16" wide jamb, Endura™ brand or ADA sills, StrikeJamb™ reinforcement, and door boring for hardware.



Unfinished in tan color, with a wood grain. Easily paintable and stainable composite jamb material. Also available smooth – without a wood grain.



Prefinished, shown with detailed wood grain. Composite jamb material will not rot, warp, split or crack.

PRE-HUNG OPTION & ADVANTAGES

Sill and Sill Color Options

All standard pre-hung exterior door units use adjustable composite sills that help prevent water penetration, rotting, warping, and discoloration. Our standard adjustable composite sill includes a peel-off film which protects the sill during construction, and is made from 100% composite materials. The “adjustable” feature allows the top of the sill to be adjusted with a screwdriver to match the correct height required for the bottom of the door. Optionally, you may select the Endura® Brand adjustable composite threshold (for an extra charge) that is made from composite and aluminum material or an ADA aluminum threshold. The ADA threshold is approved for use with wheelchairs. ADA sills are 5” x 1/2” or 7” x 1/2”. The Endura Z-Series sill system provides a walnut colored sill cap, the adjustable feature, and a hard plastic, protective construction cover.

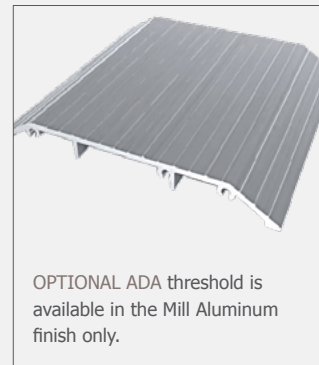
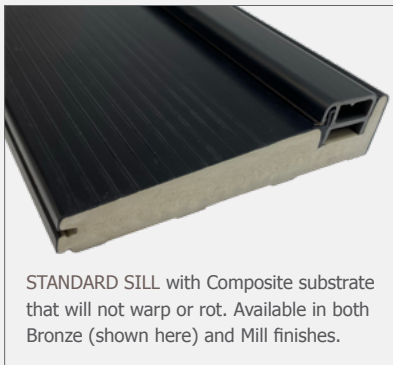
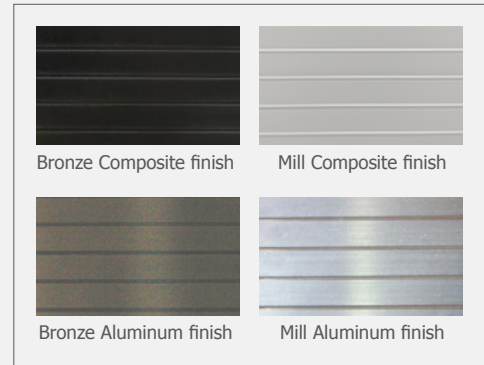

Composite Door Frames with STRIKEJAMB™

All FiberCraft pre-hung doors are available with a steel-reinforcement StrikeJamb™ as an option. Pre-hung units include jamb legs, T-astragal (for double doors), standard sill, header, weatherstripping, and adjustable threshold, plus 3 ball-bearing hinges on 6’8” tall doors and 4 ball-bearing hinges on 8’0” tall doors.

The StrikeJamb™ reinforcement can be installed on the lock side jamb leg for safety and security. This plate reinforces the jamb leg, and allows the dead bolt and the handleset bolt to throw so that the bolts extend through the corresponding holes in the steel reinforcement plates. In addition, long mounting screws should be used with this StrikeJamb, these screws extending through the jamb leg, then through the steel plate, and finally into the wall studs.

Image at right shows the reinforcing plate from the back jamb leg side, which is hidden from view after installation.



Hinge Color Options



All pre-hung 6’-8” tall units use three 4-inch ball-bearing hinges, while 8’-0” tall units use four hinges. Choose from the three hinge color options shown at left for your pre-hung entry door unit: Oil Rubbed Bronze, Satin Nickel or Flat Black.

PRE-HUNG IMPACT and WINDSTORM RATED DOORS

Impact Rated and Coastal Windstorm Approved

Protect your family and your home with GlassCraft's Impact Rated or Windstorm tested doors. Doors and entryways in this catalog with the logos shown at right below are available to ensure a high level of safety and security against break-ins and weather related impacts. Impact doors are available as slab doors or as pre-hung units.

GlassCraft Premium Fiberglass Composite doors and entryways have been evaluated for compliance and are approved for installation in designated catastrophe areas along the Florida and Texas and other coastal areas when installed as required and as specified in the International Residential Code (IRC) and the International Building Code (IBC). Both 6'8" tall and 8'0" tall entryways have been certified in a variety of entryway configurations, including single doors, double doors, and single doors with 1 or 2 sidelites. Certain Solid doors, Speakeasy doors, and doors with glass have been approved with in-swing and out-swing configurations. Proper installation is required to comply with building codes.



Pre-hung Impact door units are available with Rockwell multipoint locks with Privacy, Solid, Speakeasy, SDL, or Wrought Iron grille options and for in-swing and out-swing single and double door configurations, or single doors with 1 or 2 sidelites. Pre-hung Impact door units OR slab Impact doors (not pre-hung) are available ready for your Schlage or Kwikset lock sets with Privacy, SDL, or Wrought Iron Grille options for in-swing single and double door configurations, or single doors with 1 or 2 sidelites.

Up to 50 DP Rating for Select Impact & Windstorm Tested Composite Doors

Visit www.glasscraft.com for complete information on DP Ratings, approval numbers and availability for Impact tested product configurations.

Available Impact Approved Configurations:

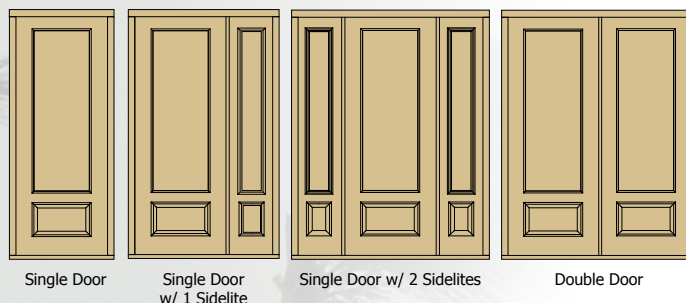

Impact and Windstorm Features:

- **Doors available.** Impact doors are available as privacy doors, SDL divided lite doors, wrought iron grille doors and certain speakeasy and solid doors. Windstorm doors include these same doors plus decorative glass doors. Modern doors and NP-Series narrow profile doors have not been tested and approved for windstorm or impact. We are continuously testing doors, so please refer to our website for current information.
- **Handle set options.** Windstorm / impact units are available for specific Schlage or Kwikset lock sets or specific Rockwell multipoint lock sets. Please note that the Rockwell multipoint handle set must include a lever-action model, not a thumb latch.
- **In-Swing or Out-swing.** Windstorm and impact units are available as both "inswing" and "outswing" units.
- **Laminated glass.** Impact rated units use laminated glass on the exterior side of the glass unit. Windstorm rated units use safety tempered glass.
- **Internal Door reinforcement.** We construct Impact-Rated doors with additional internal reinforcement to withstand potential flying-debris impact.
- **Door height & width options.** We can pre-hang the four entryway configurations shown above using our 3'0" or 2'8" wide and 6'8" or 8'0" tall fiberglass doors and sidelites.
- **Solid Composite Frames.** Offered with Windstorm rated and Impact rated pre-hung units. The composite material used in the door frames and trim is a wood-plastic composite with a wood grain. These "no-rot, no-warp" frames may be stained or painted, and the pre-hung units are available factory finished to match a prefinished fiberglass door.

STRONG and SECURE DOOR LITE FRAMES

Three Door Lite Frame Designs: Aluminum, Fiberglass & WPC

The Door Lite Frame is the moulding assembly that holds the glass in the door, GlassCraft offers 3 plugless frame designs.

Modern and Sleek PLUGLESS ALUMINUM FRAMES

GlassCraft's new aluminum door lite frames use an aluminum exterior and interior frame with a polymer internal support structure to provide a sleek and modern appearance along with a thermally-broken design to provide the maximum energy efficiency. No unsightly screws – this product provides a "plugless" frame design.

These frames are almost flush with the surface of the door, and measure 1-1/2" in width. This unique frame system allows for the replacement of your door glass should it be damaged or broken. Plus they are impervious to moisture, and resist damage due to rot and mildew.



These unique Aluminum frames are featured in our Contemporary Entry Door section starting on page 45 of this catalog and the new SSD-Series on page 58.

Solid and Strong Patented PLUGLESS FIBERGLASS FRAMES

GlassCraft's patented MetroFrame™ fiberglass door lite frames are produced using an industry-leading high-compression fiberglass reinforced frame for superior strength and stability. These frames feature a sleek shape that projects out less than 1/4" from the surface of the door, and measures 1-3/8" in width. The frames do not use external fasteners that require frame plugs to hide the screws, but rather incorporate a multi-patented clip system that does not require external screws or plugs. This unique frame system allows for the replacement of your door glass should it be damaged or broken. No need to replace the entire door as with other "plugless" frame systems. Plus they are impervious to moisture, and resist damage due to rot and mildew. Strong and secure!



Patented design of the fiberglass reinforced glass insert frame creates a strong and moisture-proof barrier. Most doors in this catalog use this fiberglass frame.

Solid and Strong Patented PLUGLESS WPC FRAMES for Windstorm and Impact

GlassCraft's ClassicFrame™ Windstorm and Impact door lite frames use an extruded solid WPC wood-polymer-composite material and are solid (not hollow) for super strength. These frames do not use external fasteners that require frame plugs to hide the screws, but instead use a patented clip system that does not require external screws or frame plugs. Impervious to moisture, and resist damage due to rot and mildew. Strong and secure, these frames are tested and approved for our Impact-Rated doors and entryways. They are used in all Arch Lite Double and Arch Top double doors in this catalog.



These frames are used when Windstorm and/or Impact doors are required, and in all "Arch Top Double" door entryways, as are found on pages 37, 62-63, and 74-75.

DECORATIVE IRON DOOR STRAPS & CLAVOS

Decorative Door Straps



28" Williamsburg Hinge Strap **HS3** Antique Black



28" Canterbury Hinge Strap **HS4** Antique Black



28" Madrid Hinge Strap **HS1** Antique Black



28" Florentine Hinge Strap **HS2** Antique Black

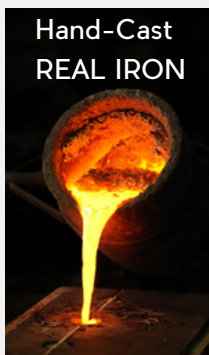

- A 6" L Strap - **CS1** Antique Black (use for top or bottom rail on R or L side of door)
- B 6" L Strap - **CS4** Antique Black (use for top or bottom rail on R or L side of door)
- C 6" Arched Strap - **CS2** Antique Black (use on the top cross rail of 2 panel door)
- D 6" Arched Strap - **CS5** Antique Black (use on the top cross rail of 2 panel door)
- E 12" T Strap - **CS6** Antique Black (use on a door mid rail)
- F 12" T Strap - **CS3** Antique Black (use on a door mid rail)

Sample Combinations of Straps



3 Door Straps
Fits 2-panel doors.



2 Door Straps + 1 T Strap
Fits 2-panel doors.
(Latch mounts opposite the T-Strap)



2 Door Straps + 2 Arched Corner Straps
For 2-panel Arch doors.

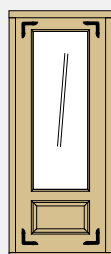

4 Corner L Straps
For use on all square top doors.



Decorative Clavos

Use these decorative "clavos" or door nails for installation onto the face of the door to give it a rustic or antique look. Clavos can be mounted on the interior or exterior or both sides of a door, and they may be used with or without the door straps shown at left. These clavos are hand-cast and handmade and therefore vary slightly.

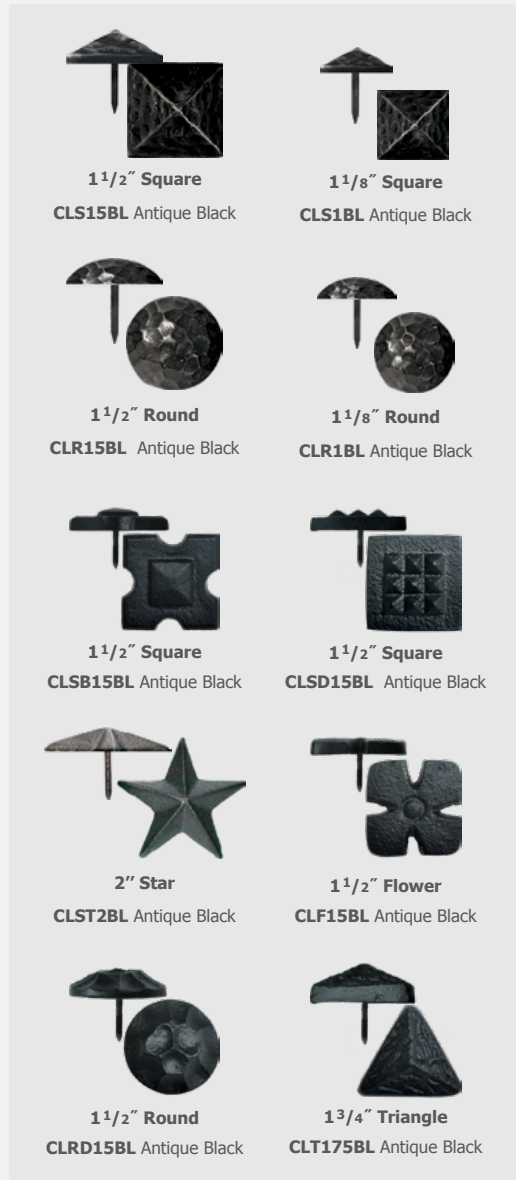

Use your cell phone camera or QRC scan app to **SCAN** for Pricing & Info >

3 OPTIONS FOR MULTIPOINT DOOR HARDWARE

Multipoint Locks Offer Strength and Security

Three different multipoint lock solutions are available for all GlassCraft FiberCraft doors. Multipoint locks offer additional security by including three locking bolts instead of just one. The 3 different solutions are:

#1 PANOLOCK MULTIPOINT The first and only multipoint lock that works with off-the-shelf hardware! Use your own handle set choice! PanoLock is a one-of-a-kind multipoint lock that works with off-the-shelf hardware, supports a forgiving installation, and offers lasting performance, all at an affordable price point. GlassCraft will machine the door and jamb and install the Panolock hardware – then you install your choice of door handle set hardware.

#2 BUFFALO FORGE / PANOLOCK MULTIPOINT (Pages 21-24) All Buffalo Forge® handlesets are available with the PanoLock multipoint upgrade. Hand forged bronze and brass quality with multipoint security and all at a great price!

#3 ROCKWELL MULTIPOINT (Pages 25-27) The Rockwell multipoint is our most economical. This multipoint system is activated with the turning of the dead-bolt lock. All 3 locking points are engaged only when the dead bolt point is locked by turning the thumb latch.

Panolock Multipoint Hardware

PanoLock is a unique multipoint door hardware system that is compatible with most off-the-shelf door hardware. PanoLock's three locking points activate with a simple turn of the key or thumb lever for the dead bolt. Home builders have asked for a simple and affordable multipoint locking system that can be used with their standard hardware such as Schlage or Baldwin. Simply use the correct lock insert (all are provided) and then mount your handle set hardware. Compatible brands include: Buffalo Forge, Endura, Schlage, Kwikset, Gatehouse, Baldwin, Brinks, Masterlock and Defiant. No dedicated hardware required. Panolock is produced by Endura.

Single Operation System

Most multipoint locks operate separately, requiring extra steps to lock the door. PanoLock delivers a single operation system by integrating the handleset with the multipoint system using the innovative latch and deadbolt adapters. Simply match the correct adapter to your hardware (see chart below). The lower operation force and rollers within the plates engage with the bolts to make locking and unlocking your door easy, even after years of use. Unlike other locks that catch easily, PanoLock's tapered bolts deliver a smooth operation even if the door is out of alignment.

Hand Set	Style	Handle Set Adaptor			Thumb Turn Adaptor				
		Square	C	Dual C+Guide	D	E	F	G	H
Schlage	Knob	x							
	Lever	x							
	Thumbpress	x							
Kwikset	Knob		x		x	x			
	Lever		x		x	x			
	Thumbpress			x	x	x			
Baldwin	Knob		x		x	x			
	Lever		x		x	x			
	Thumbpress			x	x	x			
Gatehouse (Lowe's House Brand)	Knob	x							x
	Lever	x							x
Defiant (Home Depot House Brand)	Knob	x						x	
	Lever	x						x	
	Thumbpress	x						x	
Brinks (Walmart)	Knob	x			x				
	Lever	x			x				
	Thumbpress	x			x				
Masterlock	Knob	x							x
	Lever	x							x
	Thumbpress	x							x



Panlock® Multipoint Option works with Off-the-Shelf Hardware

Whether knob, lever or thumbpress, it works with PanoLock.



GlassCraft provides the PanoLock installed into the door and pre-hung jamb unit. You provide and install your selected Entry Set into the PanoLock. Single door installation includes the PanoLock plus the installed strike plate and reinforcing roller plates. Double door installation adds an Endura astragal installed onto the inactive door panel edge. Videos are available online to assist with door entryset installation, should you have questions. Please search PanoLock on Youtube.

Key Features and Benefits

- Hardware Flexibility:** Whether knob, lever, or thumbpress, PanoLock works with most standard/off-the-shelf handlesets through the use of innovative adaptors, providing flexibility and options previously unavailable. As an added benefit, builders no longer have to specify hardware when purchasing the door, and if changes are needed, hardware can be easily and affordably replaced. Compatible brands include: Buffalo Forge, Schlage, Kwikset, Gatehouse, Baldwin, Brinks and Defiant. No dedicated hardware required.







- Shop Efficiency:** PanoLock is compatible with standard 5-1/2" center-to-center crossbores and utilizes a 2-3/8" backset, designed to deliver easy, and unrestricted rehanding.

- Real-World Performance:** PanoLock features tapered upper and lower bolts and adjustable reinforcement plates (located beneath the outer strike plates) with built-in rollers, all of which help deliver forgiving performance and smooth operation, even when conditions aren't perfect. Further, PanoLock's adjustable reinforcing Adjustable Roller Plates also include a space for anchor screws for enhanced security.

- Affordability:** PanoLock is offered at a more affordable price point vs other multipoint locks – and not just the lock itself. With simpler routing equipment and compatibility with off-the-shelf handlesets, PanoLock's entire cost of ownership is more approachable, "opening the door" for multipoint locks to be specified for a wider range of projects and budgetary needs.

- Available Finishes:** The faceplate for the mechanism (visible when the door is open) is available in bronze or brushed. The strike plates (there are 3) are available in bronze, nickel, brass, black and stainless steel.



Lock Faceplate Finishes:	Sizes:	Adjustable Strike Plate Finishes:
 Bronze Anodize  Brushed Clear Anodize	<ul style="list-style-type: none"> 6/8 8/0 	 Victorian Bronze  Satin Nickel  Bright Brass  Black  Stainless Steel

BUFFALO FORGE® CAST BRONZE & BRASS ENTRYSETS

Single or Multipoint Hardware features Cast Bronze or Forged Brass Handleset & Lock Options

Our BUFFALO FORGE brand lock sets are produced by hand-made processes utilizing molten sand-cast bronze or forged brass, and feature solid construction and precision engineered lock mechanisms. These are large lock sets with long escutcheon trim plates and they give a very heavy and strong, secure feel. Excellent design and style, with several models available for different door designs. This hardware has the look and feel of hardware costing three times the price. All use a standard Y1 Keyway. 2 keys provided. 2-3/8" backset.



casting the escutcheon plate

All of the lock sets shown on the following two pages are available with standard 2-point models (latch and dead-bolt), or with a multipoint dead bolt. All lock sets are available with matching "dummy" lock sets, which are used for double-door installations. These dummy lock sets do not have any internal mechanism, no key hole, and no thumb latch and are mounted on the "inactive" door, with two-point or multipoint lock sets used on the "active" door. See example photo on page 24 of Dummy Set.

All lock sets shown may be used for right-hand or left-hand door swings and all hardware necessary is included for either installation including 2 lever latches. Installation into the door slab and jamb is included in the price of all of these standard and multipoint lock sets. All Buffalo Forge entrysets will fit all full-sized doors in this catalog.

- Each Buffalo Forge lock set is available in 2 of 4 colors: Dark Bronze or Oil Rubbed Bronze and Satin Nickel or Antique Nickel.
- Included with these Buffalo Forge lock sets are the lock cylinder, dead-bolt, matching screws and face plate(s).

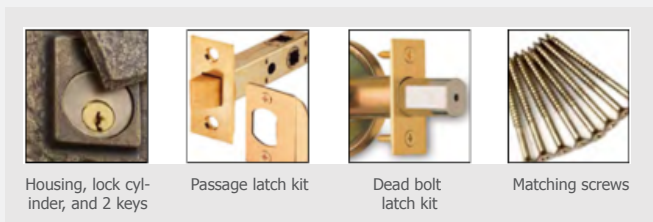

Housing, lock cylinder, and 2 keys

Passage latch kit

Dead bolt latch kit

Matching screws

Buffalo Forge - PanoLock Multipoint Option

An excellent option for all Buffalo Forge handleset models on the next 2 pages is our PanoLock multipoint lock system.

The multipoint functions exactly the same as any deadbolt, making this very intuitive and easy to operate. Instead of just 1 deadbolt, we offer this option that provides TWO dead bolts, adding a significant amount of security and strength to your entry door. In addition, this creates a tighter weather-seal, and helps to prevent against door warpage.

- 18-1/2" spacing between dead bolts
- Face plate is approx 24" long x 5/8" wide
- 1-inch dead bolt throw
- Stainless steel construction of mechanism
- Bronze cover plate and strike plates

This option will work on any handleset shown on the next two pages. Installation into the door slab and jamb is included in the price.

Door shown at right is a 2 Panel Arch door with Rustic Arch handle and multipoint option.



BUFFALO FORGE® CAST BRONZE & BRASS ENTRYSETS - LEVER LATCH

Buffalo Forge Features & Benefits

- Available with or without Panolock mutipoint lock option
- Six designs, each in 2 colors
- Made of sandcast bronze or forged brass
- 5-1/2" center-to-center boring
- Single cylinder function only
- Requires standard 2-1/8" diameter borings
- 2-3/8" backset
- Fits doors with thickness of 1-3/4"
- Swinging key flap on exterior plate
- Includes all operating parts and fastening hardware
- Left or right handing
- Dummy Sets available for each
- Dummy hardware does not include thumb latch or key flap

Rustic Fleur

DARK BRONZE



Rustic Fleur

ANTIQUÉ NICKEL

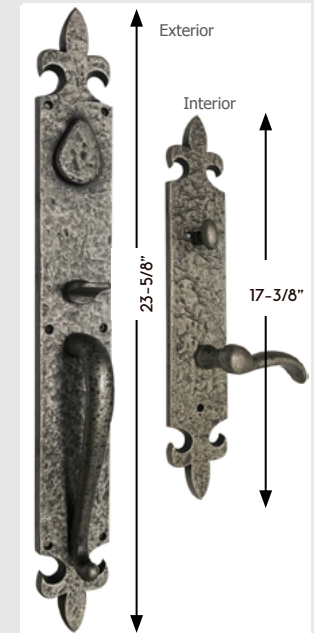

Sandcast Bronze Handleset

2 colors – Antique Nickel and Dark Bronze / Dummy Set available

Trim Plate Size: Exterior: 23-5/8" x 3"

Interior: 17-3/8" x 3"

Arch

DARK BRONZE

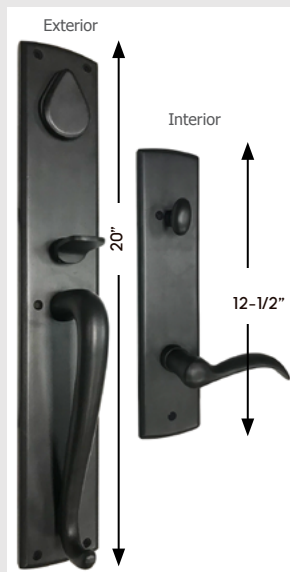

Arch

ANTIQUÉ NICKEL

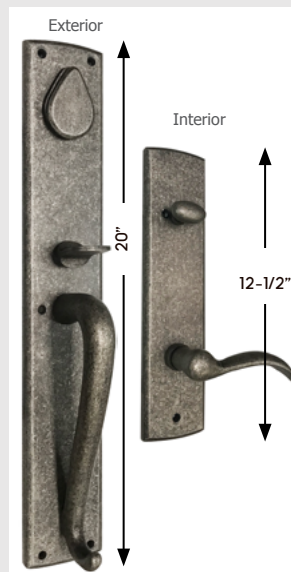

Sandcast Bronze Handleset

2 colors – Antique Nickel and Dark Bronze

Dummy Set available

Trim Plate Size: Exterior: 20" x 3"

Interior: 12-1/2" x 2-1/2"

Rustic Arch

DARK BRONZE

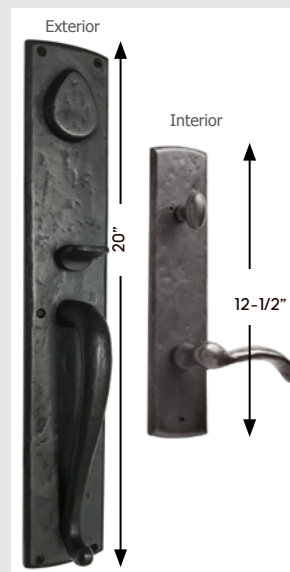

Rustic Arch

ANTIQUÉ NICKEL

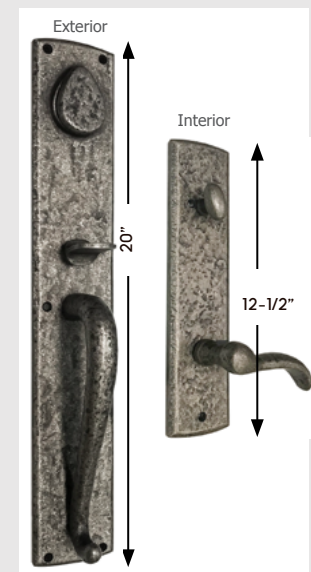

Sandcast Bronze Handleset

2 colors – Antique Nickel and Dark Bronze

Dummy Set available

Trim Plate Size: Exterior: 20" x 3"

Interior: 12-1/2" x 2-1/2"

Use your cell phone camera
or QRC scan app to **SCAN**
for Pricing & Info>



BUFFALO FORGE® CAST BRONZE & BRASS ENTRYSETS - LEVER LATCH

Stepped Arch OIL RUBBED BRONZE

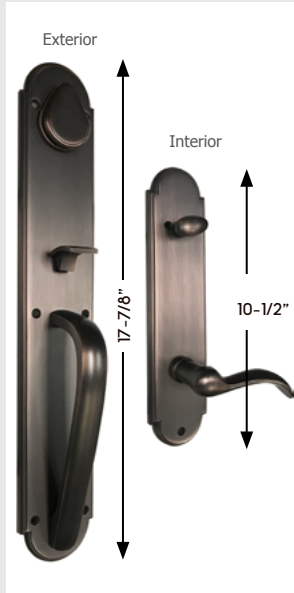

Stepped Arch ANTIQUE NICKEL

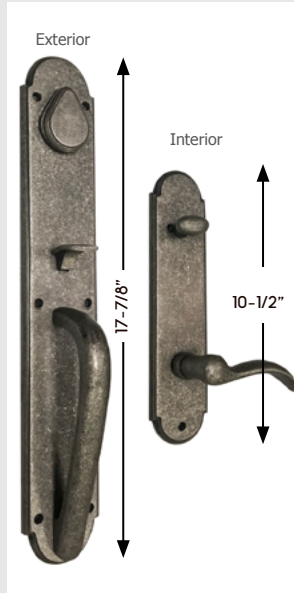

Sandcast Bronze Handleset

2 colors – Antique Nickel and Oil Rubbed Bronze
Dummy Set available
Trim Plate Size:

Exterior: 17-7/8" x 3"
Interior: 10-1/2" x 2-7/16"

Rectangular OIL RUBBED BRONZE

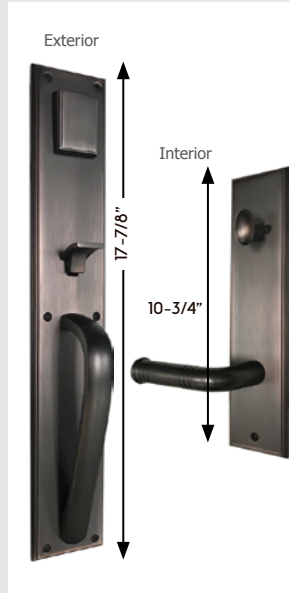

Forged Brass Handleset

2 colors – Satin Nickel and ORB
Dummy Set available
Trim Plate Size:

Exterior: 17-7/8" x 3"
Interior: 10-3/4" x 2-7/16"

Rectangular SATIN NICKEL

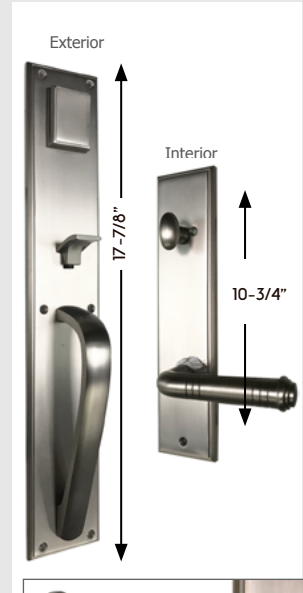

Detail photo of Rectangular lever.

Contemporary OIL RUBBED BRONZE

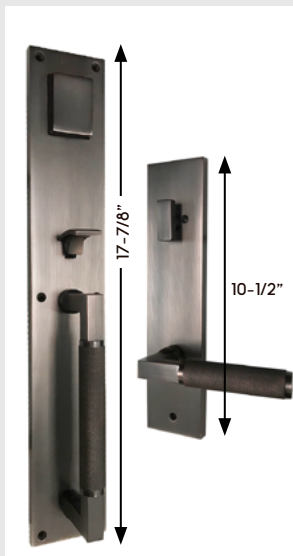

Forged Brass Handleset

(handle texture detail at left)
2 colors – Satin Nickel and Oil Rubbed Bronze
Dummy Set available
Trim Plate Size:

Exterior: 17-7/8" x 3"
Interior: 10-1/2" x 2-7/16"

Contemporary SATIN NICKEL

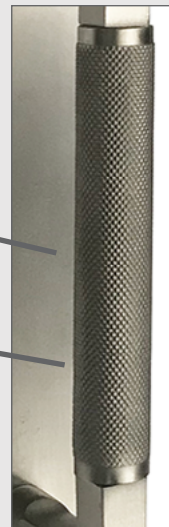
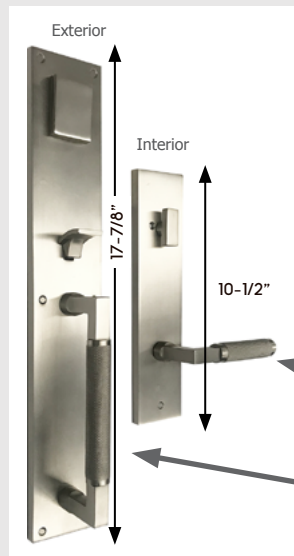

Detail of texture on Contemporary handle and lever.



All Buffalo Forge hardware are available as non-operable Dummy Sets for inactive doors, with no key flap or thumb latch. Contemporary ORB dummy shown above.



Use your cell phone camera or QRC scan app to **SCAN** for Pricing & Info>

ROCKWELL® CAST BRASS ENTRYSETS

Single or Multipoint Lock Sets Add Security – Forged Brass Handle Set & Lock Options

These lock sets are produced by the traditional drop-forged process utilizing solid brass, and featuring heavy gauge construction, a precision engineered mechanism, and superior corrosion protection. All use a standard 5 pin SC1 Keyway. Wide bow keys provided. 2-3/8" backset only.

All of the lock sets shown on the next two pages are compatible with the multipoint lock systems shown below. In addition, the **Windsor**, **Savoy**, and **San Jose** are also available as "one-point" traditional lock sets for both 6'8" and 8'0" tall doors. And all lock sets are available as "dummy" lock sets, which are used for double-door installations. These dummy lock sets do not have any internal mechanisms and are mounted on the "inactive" door, with one-point or multipoint lock sets used on the "active" door.

The **Sapphire** multipoint and dummy lock set is also available with a special "PVD" coating on the handle set and stainless steel for the multipoint mechanism for use in coastal installation applications. This is noted as "Coastal" in the item descriptions. This PVD Physical Vapor Deposition coating is harder, more resistant to corrosion and abrasion, and provides a longer-lasting coating when used in coastal areas.

All lock sets shown may be used for right-hand or left-hand door swings and all hardware necessary is included. Installation into the door slab is included in the pricing of all of these one-point and multipoint lock sets.

Rockwell Multipoint Option

Increase security and peace of mind with Rockwell's multipoint lock option with deadlocking tongues built to work with traditional grip hardware. Choose from any of the multipoint handle set trim options shown on the next two pages. This multipoint system is activated with the turning of the dead-bolt lock. All 3 locking points are engaged only when the dead bolt point is locked by turning the thumb latch.

This multipoint lock set includes an anti-saw and kick-proof center dead-bolt for maximum security and a 90-degree consumer friendly locking operation, so you visually know the door is locked when the dead-bolt knob is in the horizontal position. In addition, these multipoint assemblies are produced using heavy-gauge steel with a zinc dichromate finish per ATSM-8633 testing standard. Stainless steel models are available for both 6'8" and 8'0" sizes for coastal installation.

Multipoint lock systems use our standard flush bolts installed on the passive door of a pre-hung double door, which gives the homeowner the option to include dummy handle sets on the passive door with all multipoint lock sets.

Precision-engineered components reduce the need for service calls, providing years of trouble-free service. These multipoint assemblies have been cycle-tested to exceed 300,000 locking cycles. Adjustable strike plates allow for field adjustment during and after installation. The design of these multipoint systems allows for right hand or left hand installation with the same part.

GlassCraft provides installation of the 3-point lock mechanism into the door, and installation charges are included in the cost of these lock sets. Installation involves precision machining of the edge of the door slab, which is performed with CNC machines to ensure precision.

When ordering for double doors, only 1 multipoint lock set is required. You may choose to include a "dummy" handle set on the inactive door for appearance purposes.



Door shown above is a 2 Panel V-Grooved door with Madrid speakeasy, square clavos and multipoint Windsor lock set.

ROCKWELL® CAST BRASS ENTRYSETS - LEVER LATCH

Rockwell Features & Benefits

- Solid brass, heavy gauge construction with precision-engineered mechanism
- Compatible with multipoint lock system (page 25)
- Available with one-point lock sets for 6'8" and 8'0" doors (for Windsor, Savoy, and San Jose)
- Dummy lock sets available for inactive door in a double door entryway (no internal mechanism)
- Special PVD coating option on multipoint and dummy locksets (for Satin Nickel Sapphire)

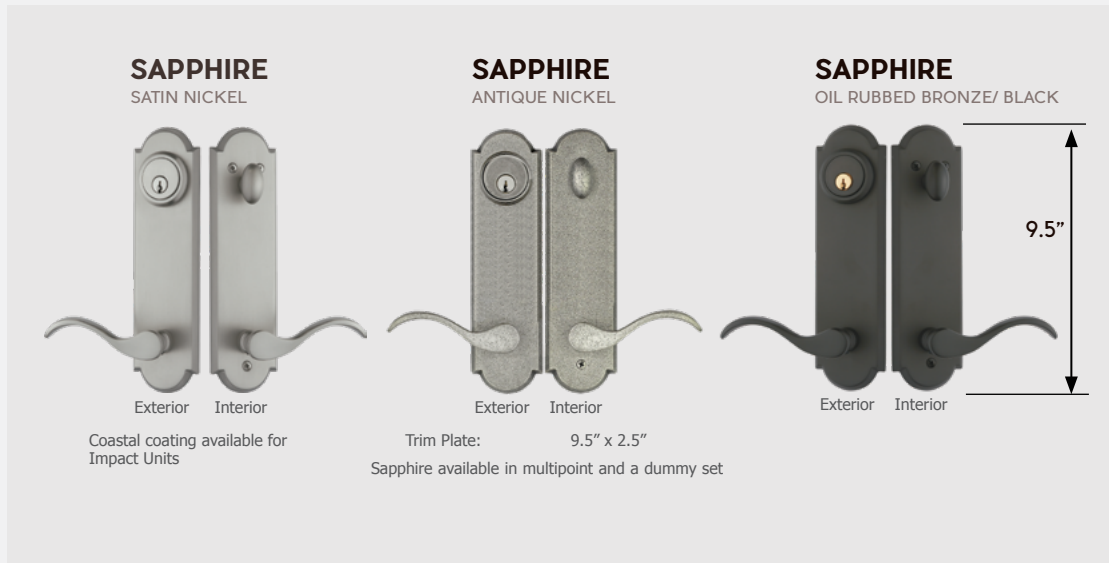

Use your cell phone camera or QRC scan app to **SCAN for Pricing & Info**



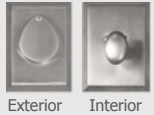

ROCKWELL® CAST BRASS ENTRYSETS - THUMB LATCH

SAVOY
SATIN NICKEL



Exterior Interior



17.0" nominal

Savoy available in multipoint or a 2-point and a dummy set

SAVOY
ANTIQUÉ NICKEL





Exterior Interior

SAVOY
ORB / BLACK



Exterior Interior



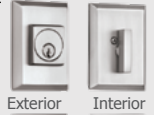

Trim Plate (top): 3.875" x 2.75"
Trim Plate (middle): 5" x 2.75"
Trim Plate (bottom): 3.875" x 2.75"

ZENIA
SATIN NICKEL



Exterior Interior



17.5" nominal

Zenía available in multipoint and a dummy set

ZENIA
ORB/BLACK

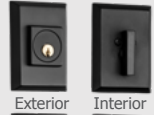

Exterior Interior





Trim Plate (deadbolt): 3.94" x 2.75"
Trim Plate (top): 5" x 2.75"
Trim Plate (bottom): 3.94" x 2.75"
Total nominal height: 17.5"

WINDSOR
SATIN NICKEL



Exterior Interior

16.25" nominal

Windsor available in multipoint or a 2-point and a dummy set

WINDSOR
ANTIQUÉ NICKEL





Exterior Interior

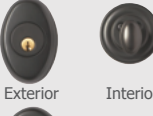

WINDSOR
ORB/BLACK



Exterior Interior





Trim Plate (top): 3.5" x 2.375"
Trim Plate (middle): 4.25" x 2.75"
Trim Plate (bottom): 2.25" x 1.5"

CARMEL
SATIN NICKEL



Exterior Interior



18.375"

Carmel available in multipoint and a dummy set

CARMEL
ORB / BLACK



Exterior Interior





Trim Plate: 18.375" x 2.5"

SAN JOSE
ANTIQUÉ NICKEL



Interior



Exterior

18.25"

San Jose available in multipoint or 2-point and a dummy set

SAN JOSE
ORB / BLACK



Interior



Exterior

Trim Plate (top): 11.125" x 2.5"
Trim Plate (bottom): 3.5" x 2.5"

LUMINA
SATIN NICKEL



Interior



Exterior

18.375"

Lumina available in multipoint and a dummy set

LUMINA
ORB / BLACK



Interior



Exterior

Trim Plate: 18.375" x 2.5"

Use your cell phone camera or QRC scan app to **SCAN for Pricing & Info**

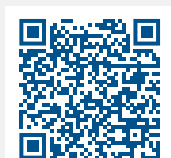

The FIBERCRAFT® SOLID PANEL & SPEAKEASY DOORS

Premium & Pro Series Solid Panel Doors & Options

The Solid Panel Premium Series and Pro Series of solid doors provide an impressive range of options and finishes that fit a wide range of home styles.

Impact Approved Entryways for Security

This Solid Section includes "Impact Approved" door options. Look for the Impact Resistant logo, and refer to page 17 for more information. Please note that all entryways that feature our real exterior wrought iron speakeasy grilles include a special coating on the wrought iron parts. This coating is applied to metal parts to resist rusting and corrosion. While this coating significantly enhances the durability of these decorative wrought iron grilles, we do not warrant the grilles or hardware finish against corrosion.



Cherry 2 Panel door with V-Grooved option, Impact speakeasy with Clear glass, Square Clavos, and Williamsburg hinge straps.

Factory Finish Options

Choose from 23 color finish options and 4 wood grains in the Estate and Artisan Collections (See pages 8-13 for photos), or from 9 paint color options in the Palette Collection™ (See pages 6-7).

Decorative Iron Straps & Clavos

Use decorative door straps (see page 19) for installation onto the face of a door to give it a rustic, or craftsman, or antique look. Door straps can be mounted on the interior, the exterior, or both sides. Straps may be used with or without the clavos shown on page 19. These door straps and clavos are hand-made and therefore vary slightly.

Door straps and clavos can be added to almost any door in any configuration.



6 Panel with Canterbury straps & square clavos.

V-Grooved Panel Option

GlassCraft's Premium and Pro Series 2-panel fiberglass doors are available with V-Grooved door panels. This popular detail adds a more rustic appearance to the door. These 2-panel doors may also be ordered without this V-Grooved option. Both doors are the same price.



Cherry door panel with V-Groove option.

Peephole Viewer Option

Add a peephole to your solid entry door and get a 180 degree view of your outside perimeter. Available in 2 colors — Satin Nickel and Oil Rubbed Bronze.



Use your cell phone camera or QRC scan app to **SCAN for More Information** about the Peephole Viewer.

FIBERCRAFT SOLID & SPEAKEASY DOORS

Speakeasy Option: Fixed or Operable

Most of our solid panel doors shown in this section may be ordered with a "speakeasy" option installed (see photos here). Two types of speakeasies are available. **First option:** An Operable Speakeasy has rectangular speakeasy door, and is installed in the upper door panel at an approximate height of 5'6". This small door is hinged and latched from the interior side of the door, and may be opened and closed from the interior side only. Six glass options are shown below. **Second option:** The Fixed Speakeasy has NO door, and is a window in the door with a clear glass option only. The fixed speakeasy allows approximately 40% more light than the Operable Speakeasy option as the glass panel is larger.

Both options – Operable or Fixed – are available WITH or WITHOUT a decorative grille. The speakeasy grilles are made of real wrought iron and available in four designs, plus one "Impact rated" grille for use in coastal installations. Impact-Rated speakeasy entries must include the Impact Florentine speakeasy grille option.



Operable Speakeasy with Seville grille and Water glass texture option



Fixed Speakeasy with no grille and Clear glass



Fixed Speakeasy grille with Star Grille and Clear glass



Operable Speakeasy Glass Options

Choose from 6 glass texture options to complement your operable speakeasy and door. (Fixed speakeasy option is only available with clear glass). Glass textures shown here are produced using a double insulated tempered glass unit to provide safety, security, and energy efficiency. The capacity to see through the glass panel varies depending upon the glass texture chosen. The Water and Flemish texture options offer a light obscured view or level of privacy. The Reeds texture option offers a moderate level of obscured view. Rain and Ocean offer the highest level of privacy.

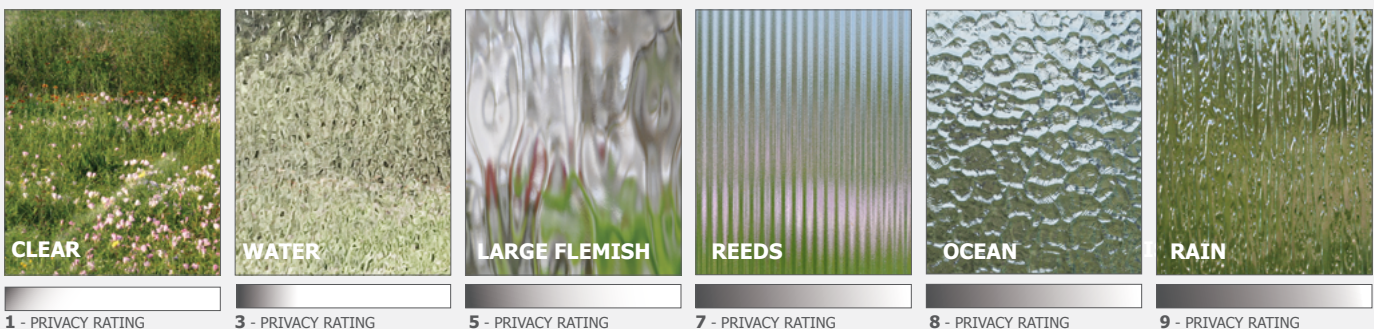



GLASS★**CRAFT**®
DOOR COMPANY

FIBERCRAFT®
IMPACT DOORS

www.glasscraft.com

Fiberglass Composite Doors for Coastal Installations

Impact Rated Composite Entry Doors

Protect your family and your home from break-ins and weather related impacts with GlassCraft's Impact Rated fiberglass doors. Order your impact door units as an assembled Impact-Approved entryway and provide a high level of safety and security for your home. Available at an additional cost and in varying configurations, these impact door units must be ordered from GlassCraft as an assembled Wind-storm-Impact Approved entryway.

GlassCraft's Impact rated fiberglass entryways have been evaluated for compliance, and are approved for installation in designated catastrophe areas along the Florida and Texas coasts when installed as required and specified in the International Residential Code (IRC) and the International Building Code (IBC).

- All impact rated doors w/ 3-point locks:
DP Rating: +50.14 / -50.14
- All impact doors without 3-point locks
(and with Schlage or Kwikset locks):
DP Rating: +45.0 / -50.0



Available Impact Handle Sets



Composite Frames and Components

Door frames, jamb legs, brick mold, mull posts, outside mullion, quarter-round and t-astragals in composite material are available. These composite components offer resistance to rotting and warping and may be prefinished to match the door. GlassCraft's composite components are made of recycled materials and offer these advantages: non splintering, excellent screw and nail retention, low linear expansion, routes beautifully without chipping or ragged edges, and accepts paint and stain like real wood without the need for priming.

Impact Pre-hung Inswing and Outswing Units

We can pre-hang the four entryway configurations shown below using our 3'0" or 2'8" wide and 6'8" or 8'0" tall fiberglass doors and sidelites. These four units are available as both "inswing" and "outswing" units. Pre-hung units include brick mold, door sweep, weatherstripping, and adjustable threshold, plus 4 hinges on both 6'8" and 8'0" doors, and astragals where applicable. IMPACT pre-hung units also include all door lock set and handle set hardware and a multi-point lock system. Please note that the multi-point handleset must include a lever-action model, not a thumb latch.

Please note that for Impact entryways, we use double jamb legs (no mull posts) between sidelites and the door, and a continuous sill.

Available Impact Configurations

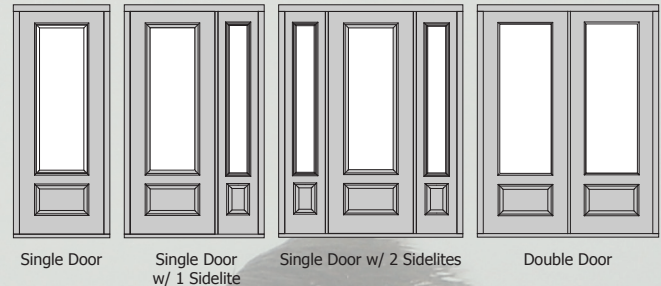

Pre-finished Composite Pre-hung Entryways: The four entry configurations shown are available professionally pre-finished to match our fiberglass doors. Refer to the FiberCraft Catalog to view all finish options, including the Estate and Artisan finish collections, and the Palette Collection of 9 paint colors.



GlassCraft's online DoorCrafter tool: Easily access information and pricing for Pre-hung, Multi-point Impact rated units by scanning the QR code found under each door in this catalog.

The Wrought Iron & Steel Grille, SDL, and Clear & Privacy Glass doors are also available as Impact rated for the door slab only, and/or with Standard lock-sets. Scan this QR for the info and pricing on those doors:



(Standard Door slab only)

Visit www.glasscraft.com for more details.



GLASS★CRAFT[®] DOOR COMPANY

2002 Brittmoore Road | Houston, Texas 77043 | 713-690-8282



Proudly Supplied By



615-885-0355 | www.warrenbros.com