

WM Coffman[®]

STAIR BUILDING GUIDE

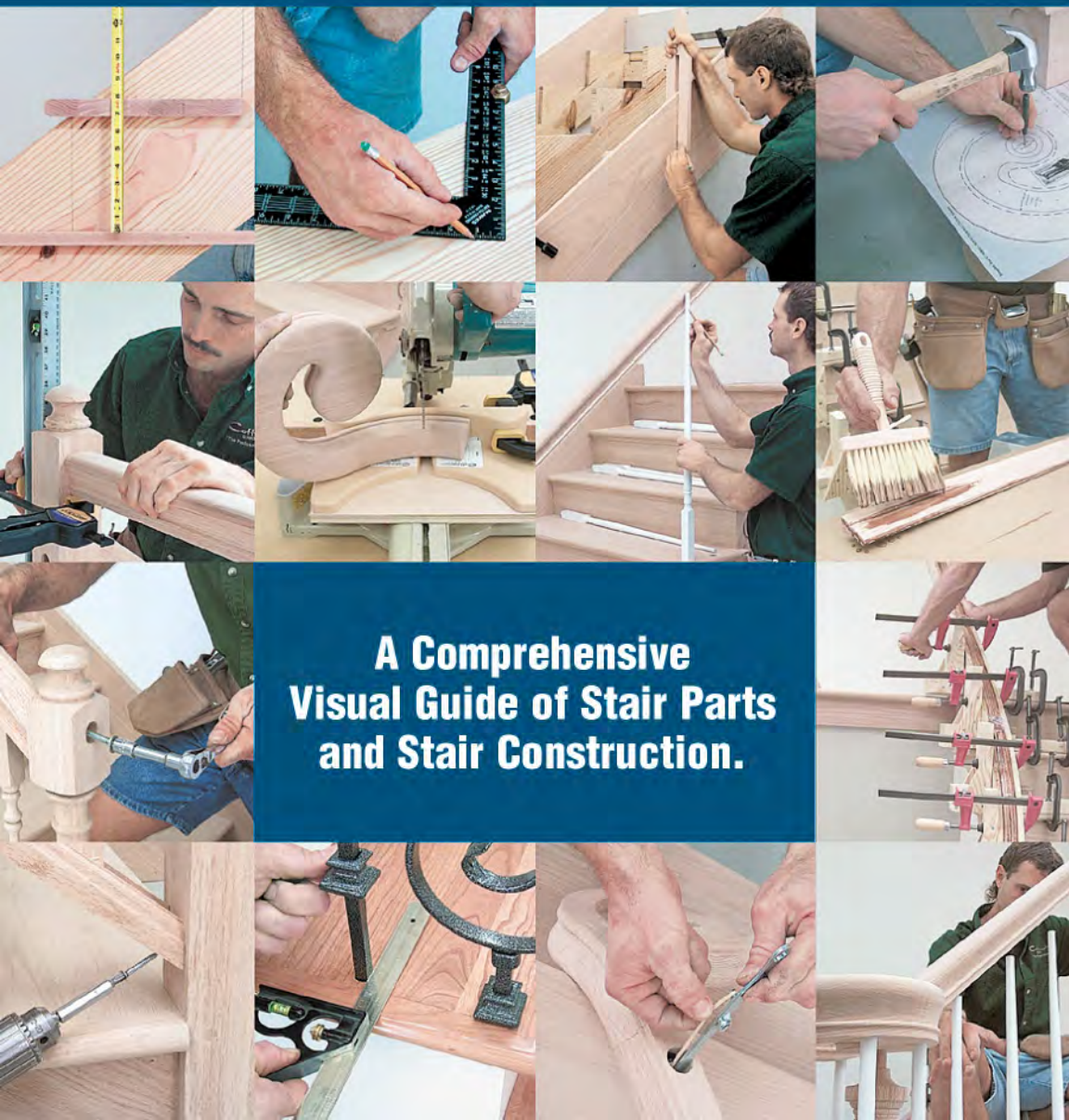

**A Comprehensive
Visual Guide of Stair Parts
and Stair Construction.**

STAIR BUILDING GUIDE

Introduction

This Stair Building Guide was born out of a single and undeniably simple concept...Given correct information in an easy to understand format, a professionally installed staircase is achievable from anyone possessing basic carpentry skills.

The key to providing a manual that succeeded in this task seemed to lie in the presentation of the information. "Correct" information was relatively easy to find in print. However, for all but the very experienced stair installer, the pages and pages of written text, along with the drawings trying to explain each concept, became anything but easy to understand. This fact, coupled with incomplete coverage and completely overlooked areas, left a huge void in information for today's stair installer.

"A picture is worth a thousand words" has never held truer than in the relatively undocumented craft of stair building. Each indexed chapter of this Guide visually deals with one segment of the installation process. Dozens of photographs cover each section in depth, allowing you to see actual job site conditions at each stage of the installation process.

The order of the chapters will allow the beginning carpenter to see the installation process from start to finish, with references to similar concepts listed where necessary for a more complete understanding. And for the more experienced stair installer looking for specific information, the one-subject chapters, index, and reference materials will provide information for a lifetime of stair building.



- Chapter 1* **STAIR BASICS** – Covers basic stair terminology and concepts.
- Chapter 2* **PART INFORMATION** – Information on specific stair parts and their uses. Learn to confidently and accurately develop a material parts list.
- Chapter 3* **ROUGH STAIR** – Covers basic aspects of the rough-end portion of stair building and design.
- Chapter 4* **STAIR BODY** – Full instructions on the finished stair body. Installation of skirtboards, treads, starting steps, risers, landing tread, decorative tread brackets, and cove and shoe mouldings, along with tread and riser caps, are covered in detail.
- Chapter 5* **BALUSTRADE LAYOUT** – The layout of the balustrade center line is one of the most important considerations at the start of any installation. Topics include standard placements along with sometime necessary alternatives.
- Chapter 6* **NEWELS** – Installed first in the balustrade portion of the installation, this chapter covers all aspects of both Post-to-Post and Over-the-Post newel applications.
- Chapter 7* **RAIL AND FITTINGS** – Topics include cutting, attaching, and terminating both PTP and OTP systems, along with full coverage of specialty fitting applications.
- Chapter 8* **BALUSTERS** – Contains all aspects of baluster installation, including permanent attachment of the rail system.
- Chapter 9* **CURVED RAIL** – Curved rail systems are easily understood with this in-depth section.
- Chapter 10* **WONDERAIL** – The adjustable stair rail system that we've put together...so you don't have to! This preassembled system of rail, shoe rail, and balusters presents the easiest and quickest form of stair installation.
- Chapter 11* **FORGED** – A complete look at the installation of Coffman's Forged Balustrade Collection.
- Chapter 12* **HARDWARE** – Easy to reference information on installation hardware used throughout the guide.
- Chapter 13* **REFERENCE** – Charts and Miscellaneous Reference Information.
- Chapter 14* **GLOSSARY / INDEX**

WM Coffman®

STAIR BASICS



CHAPTER 1

Stair Basics



1-1

POST-TO-POST VS. OVER-THE-POST

Basic concepts crucial to any discussion of stairs and stair part installation begin with the concept of Post-to-Post vs. Over-the-Post.

POST-TO-POST

Post-to-Post stairs (PTP), by definition, have the rail system installed between newel posts that extend above the rail. In Post-to-Post systems, the rail will be attached directly to the upper square blocks of the Post-to-Post newels.

PHOTO 1-1.

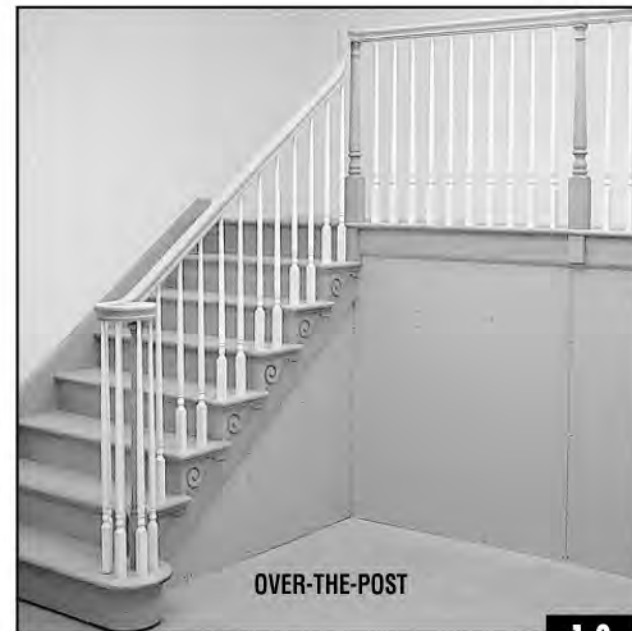

1-2

OVER-THE-POST

In Over-the-Post (OTP) applications fittings must be used with the handrail to carry the uninterrupted rail system on top of the newel posts. More simply, Over-the-Post applications will allow you to place your hand on the rail at the bottom of the stair and continue to the end of the system without ever having to remove your hand from the rail.

PHOTO 1-2.

STAIR BODY VS. BALUSTRADE

STAIR BODY

The Stair Body is most easily described as all parts that are below the walking surface of the stair. It consists of treads, risers, skirtboard, landing tread, cove moulding and shoe moulding, as well as optional decorative tread brackets and starting steps.

PHOTO 1-3.



1-3



1-5

OPEN STAIR BODY VS. CLOSED STAIR BODY

The stair body also offers two basic choices of design and can be incorporated into either PTP or OTP stairways.

OPEN STAIRWAY

Open stairways have the treads and risers exposed from the side view of the stair. Balusters in an open stair will be installed directly into the treads of the stair.

PHOTO 1-5.

BALUSTRADE

The Balustrade System is the vertical portion of the stairway that consists of newels, balusters, and rail. It supplies the structural safety of the stair while offering a multitude of design possibilities that can be tailored to the style of your home.

PHOTO 1-4.

The balustrade can further be broken down into the rake, or angled portion of the stair and the balcony, or level portion.

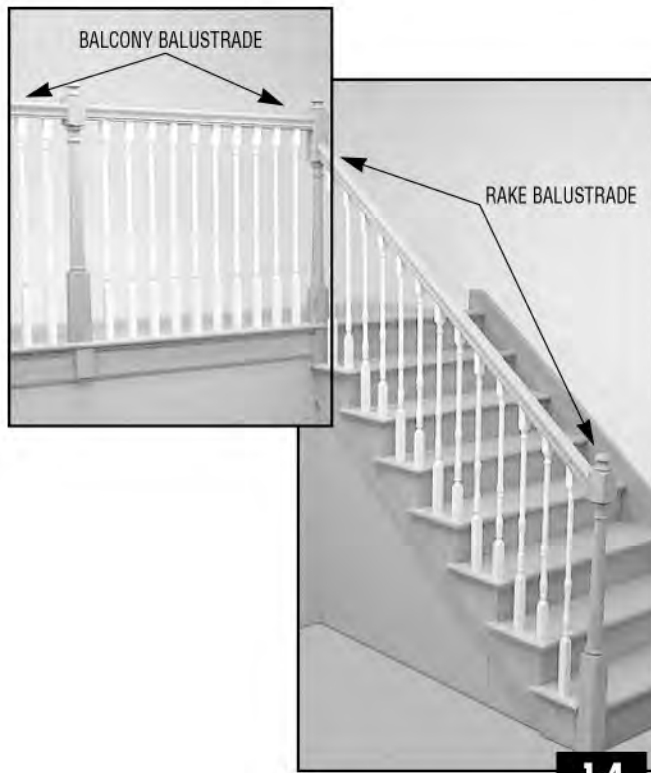

1-4



1-6

CLOSED STAIRWAY

Closed stairways use knee walls (sometimes referred to as curb walls) or full walls to enclose the stair body. Treads and risers are hidden from the side view. Balusters used in a knee wall system will be installed onto the cap of the knee wall or into shoe rail that is installed on top of the knee wall (See Photo 8-30).

PHOTO 1-6.

FULL OPEN BALUSTRADE VS. PARTIAL OPEN BALUSTRADE VS. CLOSED BALUSTRADE

Full Open vs. Partial Open vs. Closed refers to the length of the balustrade on a particular side, or sides, of a stair.

CLOSED STAIRS

Closed stairs, commonly referred to as wall-to-wall stairs, have treads and risers enclosed between two walls that extend the full length of the stair. **PHOTO 1-7.**



FULL OPEN STAIRS

Full open stairs have a balustrade portion that extends the entire side of the stair from one floor to the next. This design can be full open one side or two sides (*double open*). **PHOTO 1-8.**



PARTIAL OPEN STAIRS

Partial open stairs have an open balustrade that extends only a portion of the way up the stair before running into a structural wall. This wall will effectively create a wall-to-wall system on the upper portion of the partial open stair and can be single sided or double sided. **PHOTO 1-9.**



TYPE OF STAIRWAY: STRAIGHT, L-SHAPED, U-SHAPED, T-SHAPED, WINDER, CURVED

STRAIGHT STAIRS

Straight stairs are probably the most common stair type because of their ease to design and install. With no intermediate landings, the parts and labor requirements are usually decreased. However, straight stairs require a long hallway, which can be a disadvantage in some floor plans. **DRAWING 1-10.**

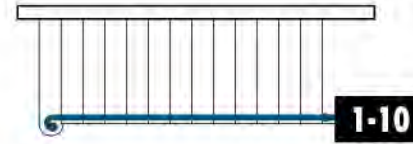

L-SHAPE

The L-shape stair affords the homeowner a more elegant, comfortable, and functional stairway. The design possibilities are increased and a landing is provided at some point in the run of the stair at which to pause or rest. Standard turns are 90°, but variations, especially 45°, are not uncommon. **DRAWING 1-11.**

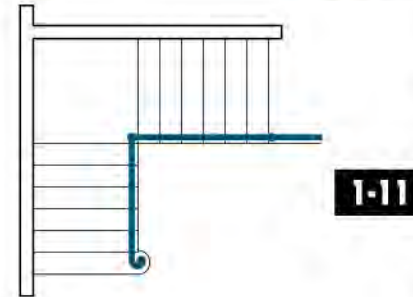

U-SHAPE

U-shape stairs are used when the design area is more square than rectangular. Two variations are the "Narrow U" and "Wide U".



NARROW U

A stair of this design introduces a single landing at least twice the width of the stairway at which point the stair will return on itself 180°.

DRAWING 1-12.

WIDE U

This stair design incorporates two landings with a short flight of steps in between to make the 180° turn. **DRAWING 1-13.**

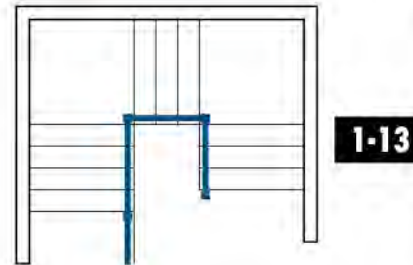

WINDER

A winder stair is one that makes a directional change without the use of a flat platform. Winder treads, nonrectangular treads used in combination, will make the necessary directional change to the stair. **DRAWING 1-14.**

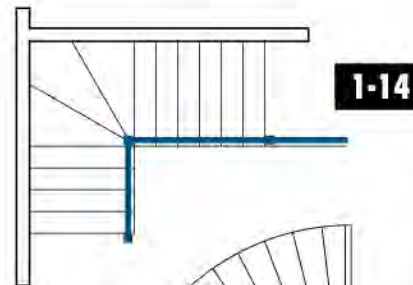

NOTE: Various codes for winder stairs (*i.e. minimum depth of tread on the short side of the winder*) are becoming more stringent. Check local building codes closely before designing a stair of this type.

CURVED

A curved stair, as its name suggests, flows in a smooth radius from one floor to the next. Curved stairs can contain balustrades on the inside radius, the outside radius, or be open both sides. **DRAWING 1-15.**

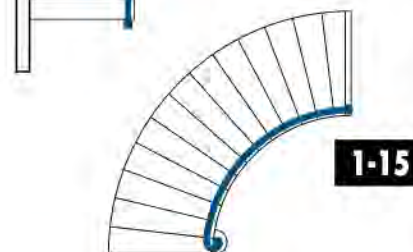

WM Coffman®

PART INFORMATION

CHAPTER 2

Part Information

2



A professionally installed staircase begins with the development of a correct material take-off and is dependent upon a working knowledge of stair product specifications and code requirements. The information in this chapter covers aspects of each stair product's specification and installation, from the introduction of products and their uses to the exact newel and baluster length requirements used during installation.

The application of this information, if viewed as one complete project, can mistakenly seem overwhelming to the person new to stair take-offs. Rather than looking at the staircase as a whole, it is advisable to break the staircase down into more easily managed sections such as the stair body, newels, fittings, rail, or balusters. Tackled one section at a time, and repeated in the same order from take-off to take-off, the development of a correct stair parts list will become an easily manageable task.

Like the basic concepts outlined in Chapter 1, an understanding of codes and how they influence product requirements is crucial to the proper specification of parts for any stair. **PHOTO 2-2.**

Always check and understand local building codes before specifying ANY stair part.

The discussion of building codes listed below is not meant to be a complete listing of necessary information for the choosing and installation of stair parts. Code bodies vary in almost all code areas and are further dependent upon the interpretation of the local officials, making a full discussion beyond the scope of this manual. However, this overview is included to offer you an introduction to building code concepts that are important to the correct specification of parts. Consulting your local building code official for final verification of code questions is always suggested because codes and their interpretation continue to change.

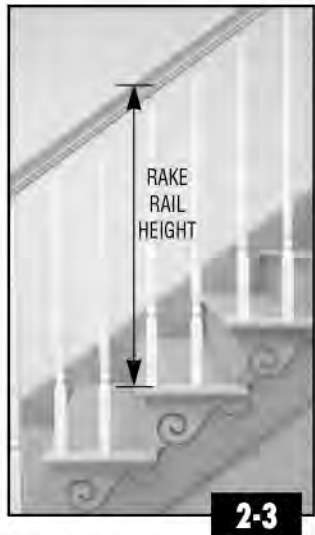

RAKE RAIL HEIGHT
Rake rail heights are measured from top of the leading edge of the nosing to the point at the top of the rail directly above. **PHOTO 2-3.**

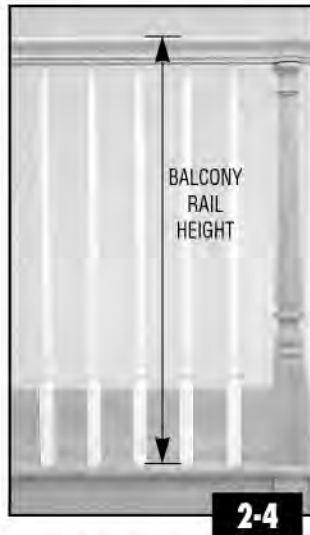

BALCONY RAIL HEIGHT
Balcony rail heights are measured from the finished floor surface to the top of the level rail. **PHOTO 2-4.**

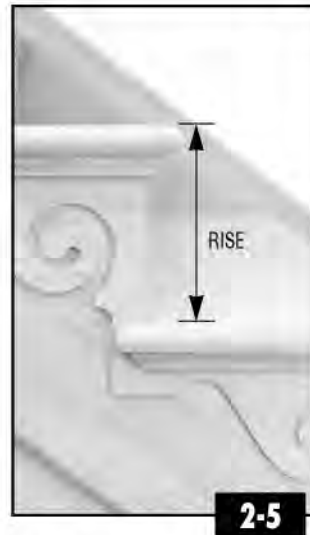

RISE
The individual rise measurement of a stair is measured from tread surface to tread surface. Some codes continue by specifying the greatest individual rise within any stair should not exceed the smallest by more than 3/8". **PHOTO 2-5.**

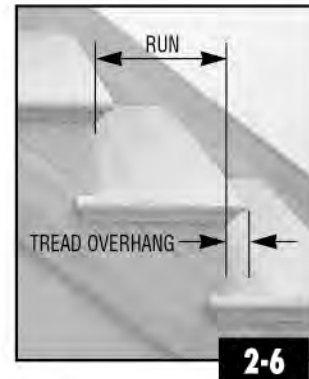

RUN
Individual tread run measurements are from riser line to riser line and do not include the overhang portion of the tread. In addition, most codes require a 3/4" to 1-1/4" tread overhang which cannot vary by more than 3/8" from the smallest to largest. **PHOTO 2-6.**



BALUSTER SPACING
Baluster spacing codes state that a sphere of a certain size, usually 4", cannot pass between the balusters at any point. **PHOTO 2-7.** This "sphere code" will affect the placement of the balusters on the treads (2 or 3 per tread. See Chapter 5, Pages 2-3) as well as the quantity of balusters needed for each balcony run.



A related "sphere code" relates to a stair that uses shoe rail (See Photo 2-74) on an open stair. The size of the triangle formed by the tread, riser, and the bottom of the shoe rail is also governed by a sphere size, usually 6". **PHOTO 2-8.**

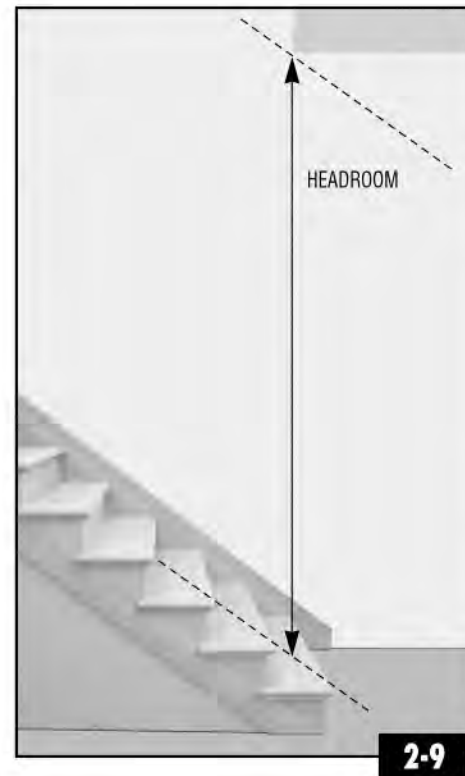

HEADROOM
Minimum headroom codes vary but are generally measured vertically from the lowest portion of the ceiling to a point along the imaginary line connecting the tread nosings. **PHOTO 2-9.**

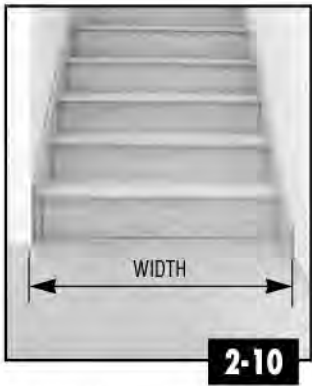

WIDTH
Minimum width of stairs is normally 36". These codes usually do not include handrail projections, which are discussed at right. *NOTE:* For two people to pass comfortably and for allowance of the passage of furniture, 42" wide and larger stairs are recommended. **PHOTO 2-10.**

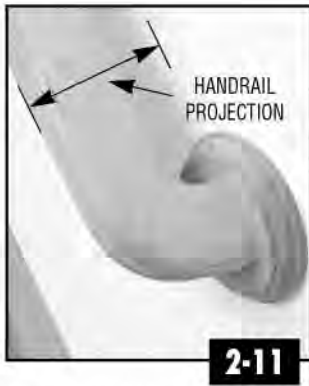

HANDRAIL PROJECTION
Projection of the handrail into the stair, measured from the edge of the rail to the wall, is generally listed at a maximum of 4-1/2". **PHOTO 2-11.**



HANDRAIL CLEARANCE
Handrails adjacent to a wall require a space between the wall and the handrail (*usually not less than 1-1/2"*). This distance must also be kept between a handrail that passes the landing tread of a balcony rail section that returns on the stair (*See Photo 5-12*). **PHOTO 2-12.**



Skirtboard material can also be used as decorative bandboards along balcony sections of the stair and along the inside wall of landings in place of baseboards. Measure lineal lengths needed, determine width to see if the skirtboard material can be ripped into two or more strips, and order accordingly. **PHOTO 2-14.**

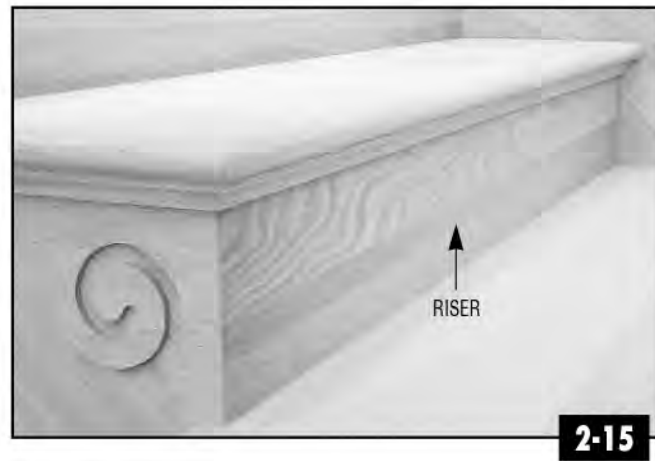

RISERS
Risers make up the vertical portion of the stair body. They are offered in 6" increments starting at 36" and in both 7-1/2" and 8" heights. Remember to allow for the extra length needed if the riser is to be mitered into the skirtboard or decorative tread brackets (*See Photo 2-31*). Order one riser per rise, except when using optional starting steps (*See Photo 2-23*). **PHOTO 2-15.**

BEGINNING A TAKE-OFF

Although one can start a take-off with any portion of the stair, the easiest order to follow for many is one that closely resembles the order of installation. This order, as followed by the chapters of this manual, begins with the stair body (*See Chapter 4*), and is followed by the newels (*See Chapter 6*), fittings and rail systems (*See Chapter 7*), and balusters (*See Chapter 8*).

STAIR BODY

SKIRTBOARDS

Open and closed side skirtboards, which are normally 3/4" x 11-1/4" boards (C-6975), serve the dual role of providing a scuff-barrier between the stair and the finished wall while adding a decorative accent to the stair. **PHOTO 2-13.** Like most lineal products, skirtboards are sold in even lineal footage from 4' to 16'. Allowing for a waste factor, necessary lengths can be obtained by measuring the horizontal distance along the slope of the stair or by using the simple formula below that works with all lineal products used on the rake portion of the stair.

Lineal Product Length = Number of treads x 13"
(rounded up to the nearest even length)

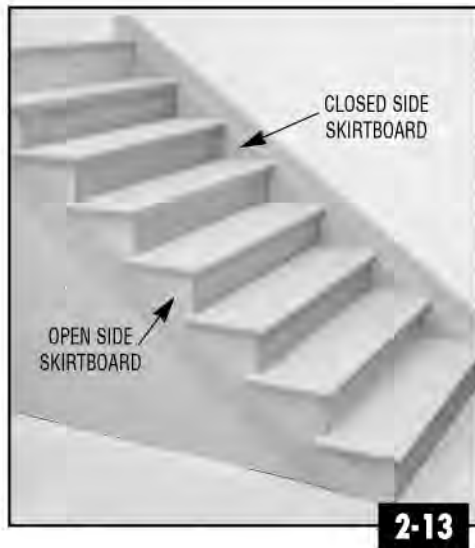

TREADS
Treads provide the walking surface of the stair and are also offered in 6" increments starting at 36". Standard tread widths are 10-1/2" or 11-1/2". When ordering, remember to add the code-mandated overhang measurement to the individual tread run. (*Example: A 10" run, under most overhang codes, would require a tread between 10-3/4" and 11-1/4". See Photo 2-6.*) Order one tread per run, except when using optional starting steps **PHOTO 2-16.**

NOTE: The necessary quantity of treads for a stair will never equal that of risers. There will always be one less tread than riser for every straight run because the last riser at the top of the run does not have a corresponding tread.

Treads are offered in three standard types:

1. Plain – With square ends, for use in closed, wall-to-wall systems. **PHOTO 2-17** and **PHOTO 2-18**.

2. Mitered Return (MR) - For use in single sided open stairs. A mitered nosing is applied to one side of the tread. This nosing will extend past the end of the riser by 1-1/4" and will be installed flush to the side of the skirtboard. Specify Right-Hand, Left-Hand, or Reversible. **PHOTO 2-19** and **PHOTO 2-20**.

NOTE: A mitered return tread is manufactured by applying the mitered return to a plain tread. Although the overall length of the tread remains the same, the return will use 1-1/4" of the overall length on the outside of the skirtboard, effectively reducing the "usable length" of the tread by 1-1/4".

3. Double Mitered Return - These treads are used on double open stairs and are custom manufactured to exact specifications for an individual job. Specify exact outside to outside measurement of the finished stair. **PHOTO 2-21** and **PHOTO 2-22**.

NOTE: If ordering from a measurement taken from the outside of the rough carriages, you must add finished material thicknesses for both sides (i.e. *sheetrock, skirtboards, decorative tread brackets, etc.*) to the measurement before ordering.

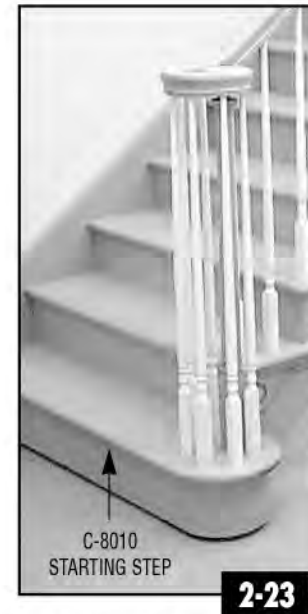
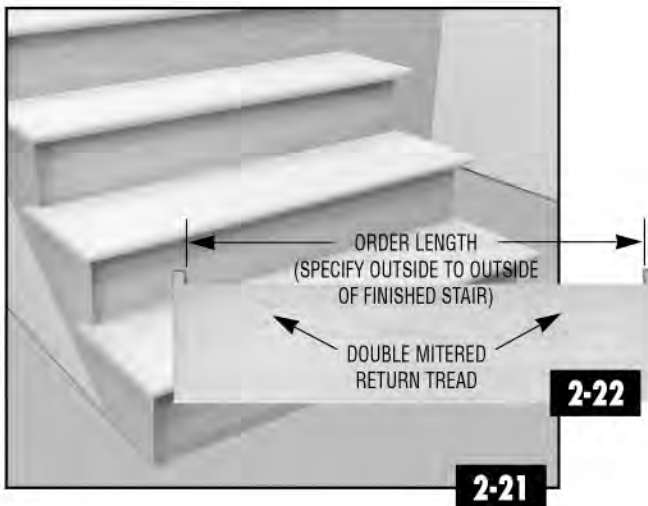
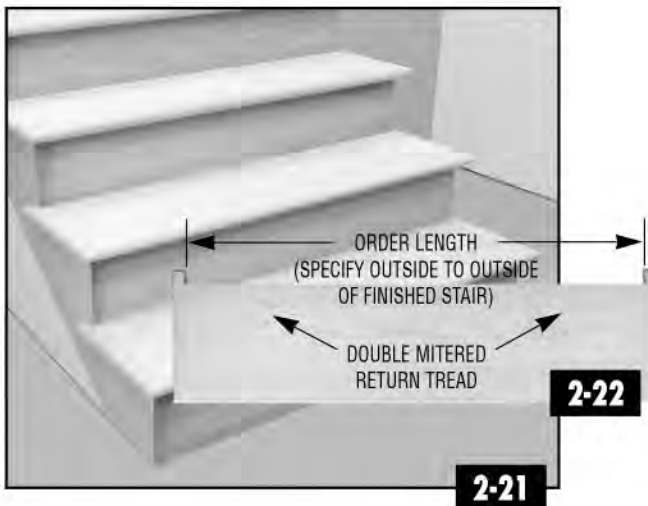
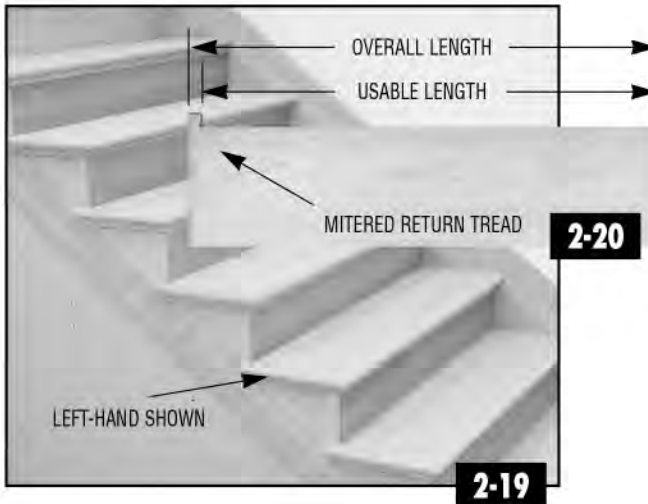
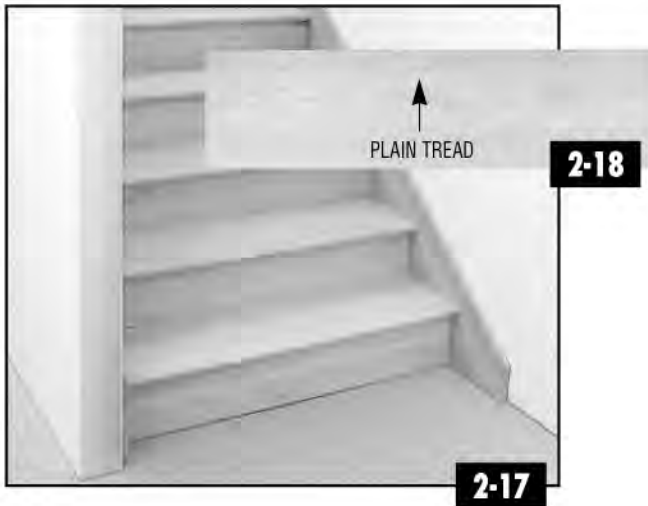

STARTING STEPS

Starting steps, offered in a variety of designs, make numerous style options available for the beginning of a stair. The most common starting step, the C-8010 Single-End Bullnose Starting Step, is required when using a volute or turnout in an Over-the-Post application. **PHOTO 2-23**. All starting steps are shipped complete with the bullnose riser, starting tread, and all cove and shoe mouldings associated with installation. Remember to decrease the number of treads and risers normally required by one each when a starting step is utilized. **PHOTO 2-24**.

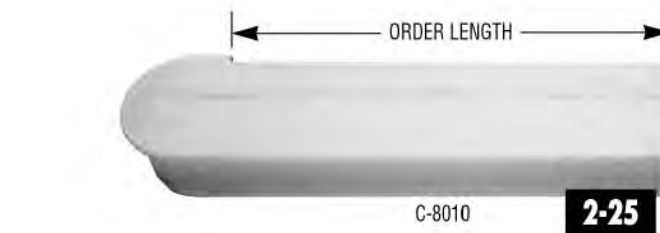

Single-End Bullnose Starting Steps are manufactured in 6" increments, measured from the throat opening, beginning with 48" (i.e. 48", 54", 60", etc.). **PHOTO 2-25**.

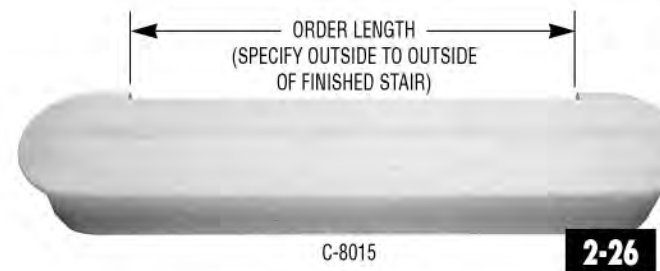

C-8015 Double-End Bullnose Starting Steps will be required when volutes or turnouts are used in a double open stair. Like the double-end tread described earlier, the measurement of the opening of the step must be specified. Remember to account for finished materials when determining the finished opening width. **PHOTO 2-26**.

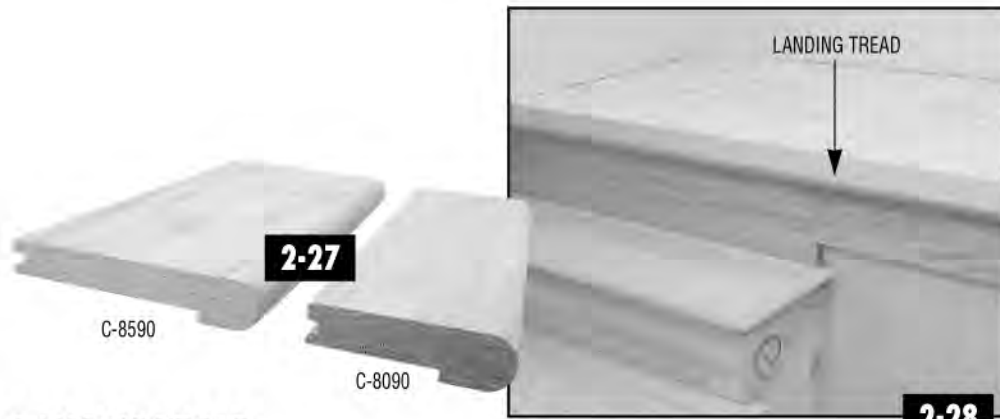

LANDING TREAD

Coffman landing tread, offered in 3-1/2" widths (C-8090) and 5-1/4" widths (C-8590), is used at all landings and along all balcony portions of the stair. This product allows a transition from the stair to the finished floor material while providing a surface for the mounting of the balusters. **PHOTO 2-27** and **PHOTO 2-28**.

Landing tread is offered in even lineal lengths from 4' – 16'. Measure all landings and balcony sections and order necessary lineal footage.

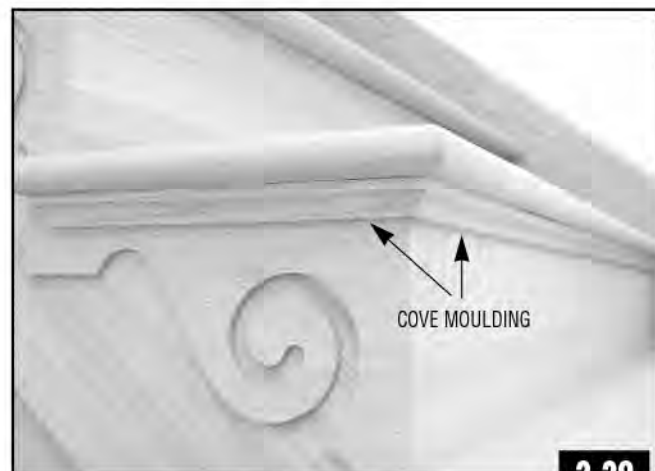

COVE AND SHOE MOULDING

The use of cove moulding and shoe moulding to trim a stair will enhance the stair's finished appearance. Different uses of the product are sometimes preferred based on homeowner's preferences, but generally are installed in the following locations.

Cove moulding is installed under the front nosing of each tread, along the side return of each tread in open stairs, and under all landing tread. When measuring for cove moulding, remember to allow for a suitable moulding waste factor. **PHOTO 2-29**.

Shoe moulding is installed at the base of the first riser, on top of wall side skirtboards and bandboards used on intermediate landings, and underneath open side skirtboards and bandboards used on balconies. **PHOTO 2-30**.

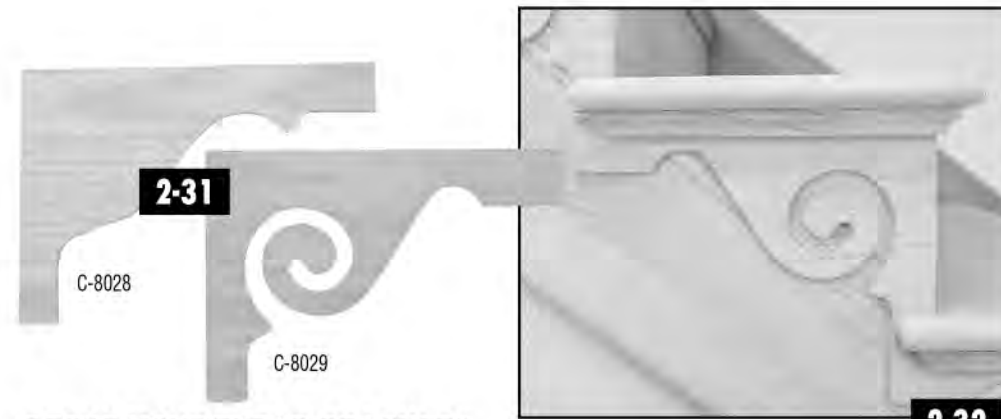
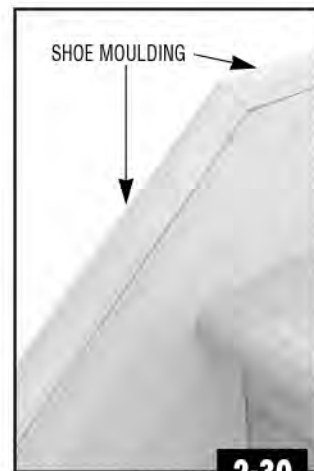

DECORATIVE TREAD BRACKETS

C-8028 and C-8029 Decorative Tread Brackets are 1/4" inch thick brackets that, as an option, are used to add a finished accent to the stair. When specified, tread brackets are installed onto the outside of the skirtboard directly under each tread in the system. Order one tread bracket per tread, excluding starting steps, in the stair. **PHOTO 2-31** and **PHOTO 2-32**.

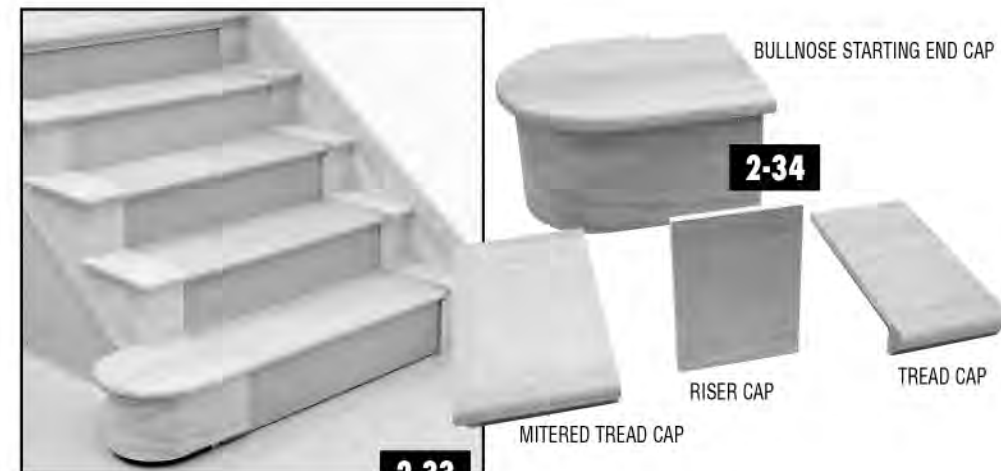

TREAD CAPS, RISER CAPS, AND BULLNOSE STARTING END CAPS

Tread, riser, and starting step caps are used as an economic alternative to full treads and risers when a carpet runner is to be used on the stair. **PHOTO 2-33** and **PHOTO 2-34**.

For each open tread order one mitered return tread cap and one riser cap. If the carpet runner is to be placed in the center of the stair, add one plain tread cap, along with another riser cap, for each tread in the system. Closed, wall-to-wall systems will require two plain tread caps and two riser caps for each tread in the system. Like full length starting steps, the use of turnouts and volutes will require the use of a bullnose starting end cap. These steps come complete with tread, bent riser, and mouldings and will replace the need for a tread cap and riser cap on the first run.

NEWELS

Newels serve as the main structural support of the balustrade portion of the stair. Proper placement, coupled with proper installation techniques, is critical to a structurally sound and code compliant staircase. Newels should be placed at the top and bottom of every stair, at all directional changes, and at intervals of not more than 8' on level balcony runs. **PHOTO 2-35.**

Newel placement categories can generally be identified as starting newels, intermediate landing newels, balcony landing newels, and intermediate balcony newels.

DRAWING 2-36.

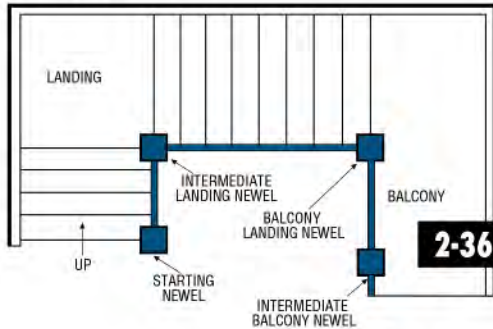

2-35



2-39

INTERMEDIATE LANDING NEWELS

Intermediate landing newels will have angled rail entering and exiting the upper square block from adjacent sides. Because the newel is basically making up for two rise dimensions in the stair (*the last rise before the intermediate landing as well as the first rise of the second straight run*), a longer square block is necessary to keep consistent rake rail heights from the first run to the second. A newel with a minimum 13" top block will be required. **PHOTO 2-39.**



2-40

BALCONY LANDING NEWELS

Balcony newels will have angled rail entering from the lower side of the newel with level rail exiting from the top of the upper block. Because only one rise dimension is involved, a 10" top block will normally be required. **PHOTO 2-40.**

NOTE: Larger than average increases from rake rail height to balcony rail height (*Example: 34" to 42"*) will not work with a 10" top block. The use of a larger top block or the use of a gooseneck (*See Photo 2-43*) may be necessary in these larger rail height differences.



2-41

BALCONY INTERMEDIATE NEWELS

Balcony intermediate newels will have level rail entering and exiting the upper block of the newel. A 5" top block is recommended. **PHOTO 2-41.**

POST-TO-POST NEWELS

PTP newels are designed with upper (*top*) square blocks that will receive the handrail. Standard block sizes (5", 10" and 13") are provided for use at various locations of the stair.

PHOTO 2-37.

NOTE: Some families of PTP newels contain block sizes that vary from the standard block sizes listed above. An understanding of why the different block sizes are necessary will allow you to apply the criteria to the varying sizes.



2-37



2-38

STARTING NEWELS

A 5" top block will always work at the beginning of the stair. Larger top blocks are unnecessary and can appear top-heavy. **PHOTO 2-38.**



2-42



2-43

USE OF FITTINGS WITH PTP NEWELS

The use of easings and goosenecks in PTP systems make the need for longer square blocks unnecessary. Order a 5" upper block newel at all locations. **PHOTO 2-42** (*easing*) and **PHOTO 2-43** (*gooseneck*).

OVER-THE-POST NEWELS

All Over-the-Post newels are manufactured with a 3/4" diameter pin turned into the top of the newel that will be installed into the underside of the fittings used in the rail system. **PHOTO 2-44**.



2-44



2-45

OTP newels are manufactured in two basic designs. Doweled bottom newels have a 1-1/2" diameter dowel designed into the bottom of the newel that is used to install the starting newel into a starting step. The height of these newels cannot be adjusted, making correct specification critical in achieving desired rake rail height. **PHOTO 2-45**.



2-46

ADJUSTABLE NEWELS

An option available in all Coffman families to the fixed length doweled newels is the adjustable newel. These newels have a 1-1/2" diameter by 10" hole bored into the bottom of the newel and are shipped with a loose 19" dowel in the carton. These newels allow the installer to trim the newel (up to 4") to achieve exact rake rail heights over a wide variety of applications. See *Chapter 6, Page 5* for more information on adjustable newels.

PHOTO 2-46 and **DRAWING 2-47**.

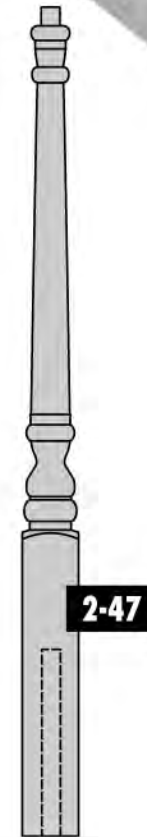

2-47

Square bottom newels make up the remaining OTP newel line and, subject to length requirements, can be used in all applications.

NEWEL HEIGHTS

To specify newels correctly, the desired handrail height (subject to code requirements) and the relationship that the height and placement of the newels play in achieving it must be understood.

The height of the installed newel, in correlation with newel placement, is the main determining factor in the rake rail height achieved.

It is also important to understand that when dealing with rake rail heights, fixed variables such as tread overhang and angle of the stair, along with variances inherent to job site conditions, do factor into the rail height obtained. Variances of up to 3/4" on the recommended newel heights can be expected in certain conditions and should be accounted for when trying to achieve specific rail heights.

The recommended newel heights are based on a 34" rake rail height, a 7-1/2" rise, a 10" run, and a 1-1/4" tread overhang and are dependent on the location of the newel matching the standard location listed with the application.

PTP STARTING NEWELS

Standard Post-to-Post starting newel placement locates the center of the newel directly above the front edge of the first riser. The measurement given is from the top of the tread to the center of the upper square block and does not include any portion of the newel that extends below the tread or above the top of the rail. The rail will be centered on the top block. **PHOTO 2-48.**

PTP INTERMEDIATE LANDING NEWELS

Standard PTP intermediate landing newel placement, like starting newel placement, aligns the center of the newel above the front edge of the riser it sits above. This newel is sometimes easier to understand when thought of in its function as a starting newel for the second straight run of the stair. Although performing the same function, the 13" top block will not allow you to use the same measurement points in *Photo 2-48*, which uses the center of the 5" block for a point of reference. Locate and mark the desired center point for the rail from the top of the upper square block. A measurement equal to one-half the upper square block of the starting newel (for 5" blocks measure down 2-1/2", etc.) will result in the same amount of reveal left above the top of the rail. The measurement in *Photo 2-49* should then be added to this mark to determine the height of the newel to the top of the tread. **PHOTO 2-49.**

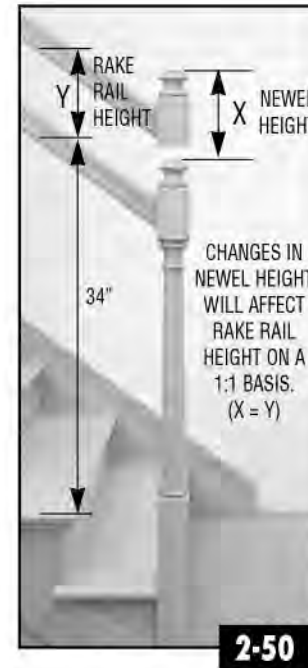
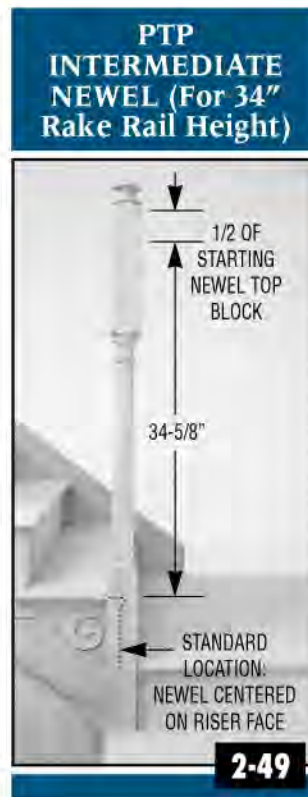
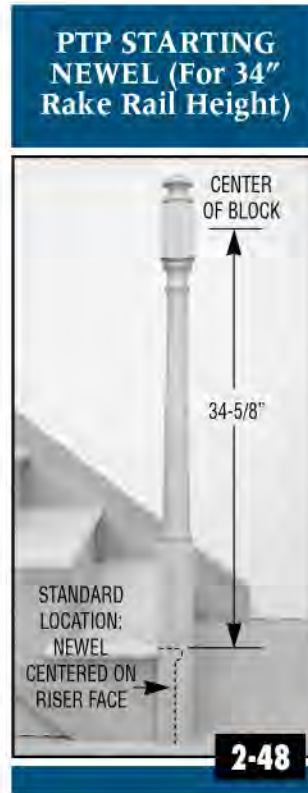

NEWEL HEIGHT ADJUSTMENTS FOR OTHER RAKE RAIL HEIGHTS

All newel measurements listed are for 34" rake rail heights. A change in newel height will have an equal effect on the rake rail height (1:1 effect). The newel height for any rake rail can be easily achieved from the base numbers listed. Simply add or subtract the difference in rake rail height desired to the base number listed. (Example: For a 36" rake rail height, add 2" to the base number. For a 30" rake rail height, subtract 4".) **PHOTO 2-50.**

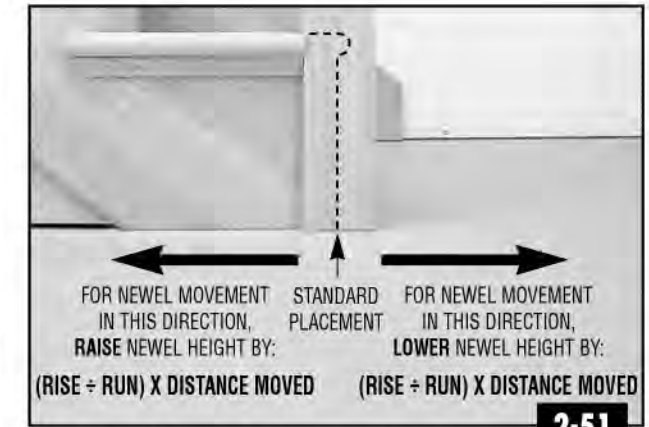

NEWEL HEIGHT ADJUSTMENTS FOR NONSTANDARD PLACEMENT

Some stair applications require the movement of the newel, either into or away from the stair, from the standard placement. To achieve the same rake rail height with a nonstandard newel placement, the height of the newel must be adjusted. This adjustment is geometrically tied to the angle of the stair and can be determined by the following formula: (Rise ÷ Run) x Distance Moved. This formula works for both PTP and OTP newels, including newels installed on starting steps. **PHOTO 2-51.**

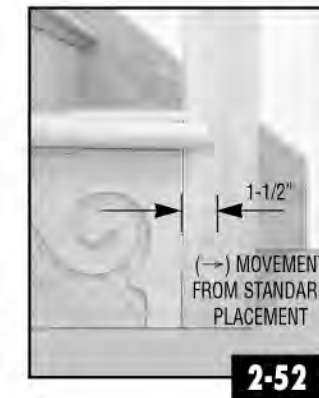

EXAMPLE: An unnotched 3" newel placed against the edge of the first riser would move the center of the newel away from the stair by 1-1/2" from standard placement. A rise and run of 7-1/2" and 10" would result in a SHORTENED newel requirement of $(7.5 \div 10) \times 1.5 = .75 \times 1.5 = 1-1/8"$. (Ex: For 34" rake rail height $34-5/8" - 1-1/8" = 33-1/2"$) **PHOTO 2-52.**

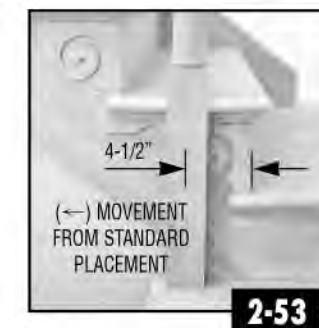

EXAMPLE: An intermediate landing newel, moved into the stair, will require a longer newel. A movement of 4-1/2" from standard placement in our example stair with a 7-1/2" rise and 10" run would result in a LENGTHENED newel of $(7.5 \div 10) \times 4-1/2" = .75 \times 4-1/2" = 3-3/8"$. (Ex: For 34" rake rail height $34-5/8" + 3-3/8" = 38"$) **PHOTO 2-53.**

BALCONY LANDING AND INTERMEDIATE BALCONY NEWELS

Balcony newels must be installed to a height that will allow the rail to meet the required balcony rail height. Measure down from the top of the upper block of the newel to a point that will leave the desired reveal. The balcony rail height must then be added to this mark to determine the height of the newel to the top of the landing tread. Again, when determining overall length for ordering, remember to account for the portion of the newel above the top of the rail and the optional notched portion below the tread.

PHOTO 2-54.

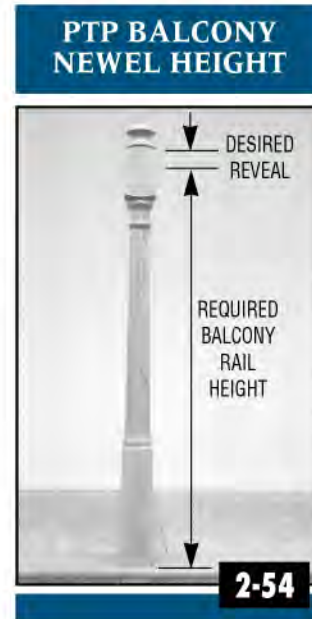

OTP STARTING NEWELS

Over-the-Post rail systems, by definition, will begin on top of the starting newel with a starting fitting. Standard options include a starting easing, a turnout, or a volute, with ascending volutes and specialty vertical volutes completing the options.

STARTING EASINGS





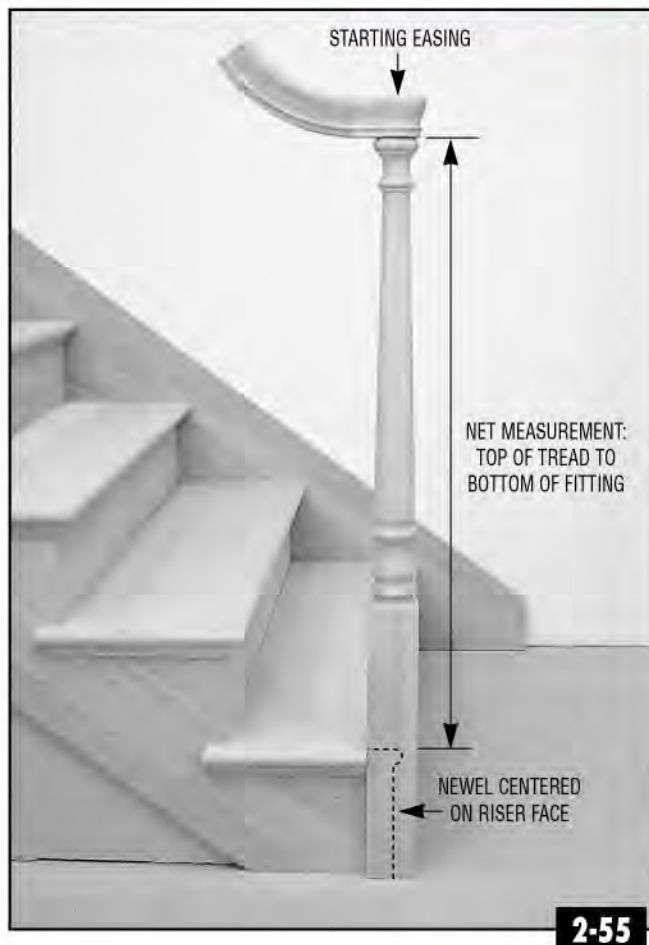



Placement of starting newels for starting easings, like PTP newel placement, aligns the center of the newel above the face of the first riser. Measurements given in *Table 2-58* are net measurements of the newel from the top of the tread to the bottom of the fitting and will not include the top newel pin, which will be inserted into the fittings, nor the notched portion below the top of the tread.

PHOTO 2-55.

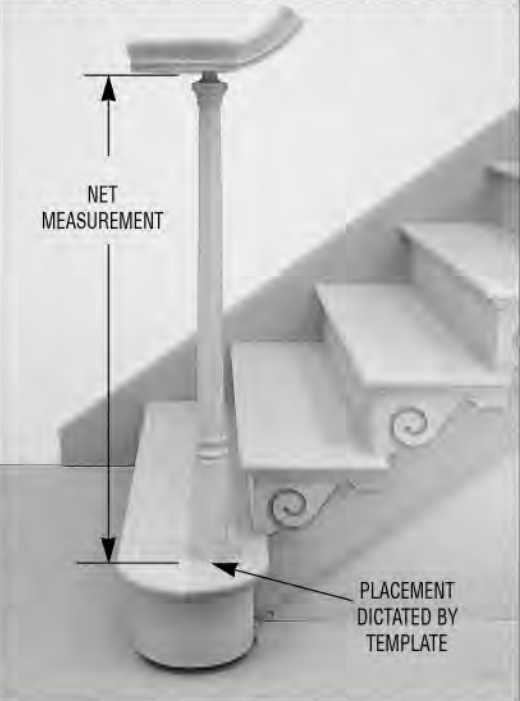

Recommended heights for the following newel placements in **Table 2-58** are based on a 34" rake rail height, a 7-1/2" rise, a 10" run, and a 1-1/4" overhang and are dependent on the location of the newel matching the standard location listed with the application. Variances of up to 3/4" can be expected in certain conditions and should be accounted for when trying to achieve minimum code heights.

OTP STARTING NEWEL HEIGHTS (For 34" Rake Rail Height)

				
STARTING EASING	TURNOUT	VOLUTE	ASCENDING VOLUTE	VERTICAL VOLUTE
Net Measurement 36-1/2"	Net Measurement 40-1/2"	Net Measurement 39"	Net Measurement 36"	Measurement 33-7/8"
				
NET MEASUREMENT	NET MEASUREMENT			MEASUREMENT: TOP OF TREAD TO TOP OF NEWEL
NEWEL CENTERED ON RISER	PLACEMENT DICTATED BY TEMPLATE			NEWEL CENTERED ON RISER

2-58

Rake rail height requirements other than 34" can be adjusted on a 1:1 basis (See Photo 2-50).

Newel heights for nonstandard newel placements can be adjusted, either up or down depending on the direction of the movement, by the following formula:
 $(\text{Rise} \div \text{Run}) \times \text{Distance Moved}$ (See Photo 2-51).



2-59

OTP INTERMEDIATE LANDING

The function of the intermediate landing newel is to serve as the starting newel for the next straight run of the stair. In Over-the-Post systems, the design of the upper side of the intermediate landing gooseneck imitates a starting easing (See Photo 2-55).

PHOTO 2-59. Placement and height requirements will match those of the starting easing. **TABLE 2-60.**

INTERMEDIATE LANDING NEWEL HEIGHT (For 34" Rake Rail Height)



Net Measurement
36-1/2"

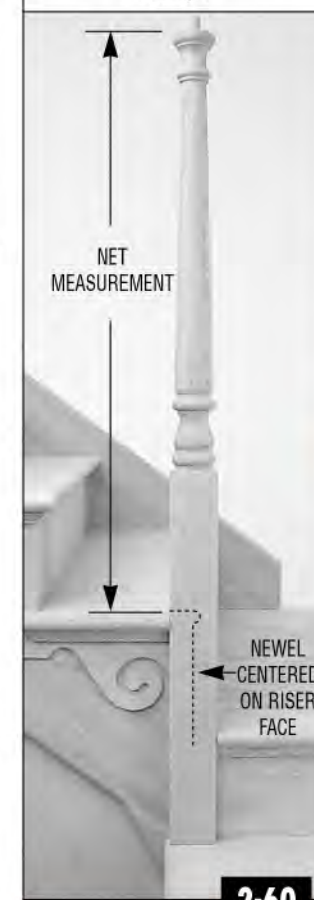

2-60

OTP BALCONY NEWEL HEIGHT

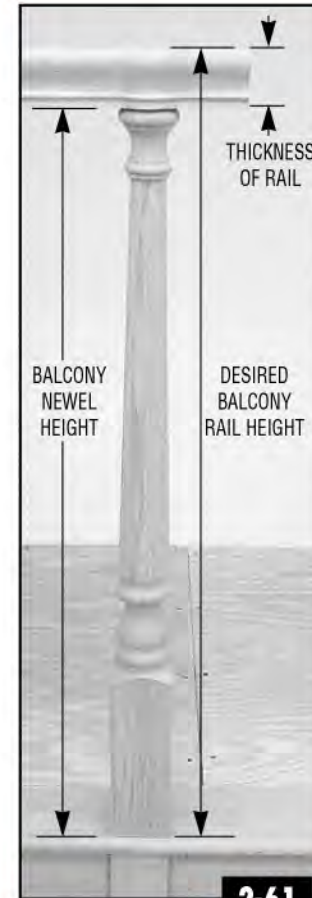

2-61

OTP BALCONY NEWELS

Balcony rail heights are a function of the height of the Over-the-Post newel and the height of the handrail. **PHOTO 2-61.** Newel height from the finished floor to the top of the newel, excluding the 1" newel pin, can be determined by using the following formula:

Desired Balcony Rail Height Minus Thickness of Rail

FITTINGS

Fittings, components used within rail systems, can be incorporated into both PTP and OTP stairs. **PHOTO 2-62.** In OTP rail systems, fittings are required to start the rail system, to make directional and height transitions, to carry the rail over intermediate balcony newels, and to terminate the rail when using a half newel. A good check of any Over-the-Post parts list is to make certain that a fitting is ordered for each newel, including half newels, in the stair.



2-62



2-63

NOTE: Coffman fittings are shipped with all necessary rail bolts, 1" tapered rail plugs, templates, and full instructions to provide a quick, accurate, and professional installation. **PHOTO 2-63.**

When ordering Coffman fittings, care must be taken to assure that the profile of the fitting ordered matches that of the rail. The second digit of the four digit identification number identifies the rail profile and must match the second digit of the rail identification number. (Example: Traditional C-6010 rail will require C-70?? fittings, Classic C-6210 will require C-72??)

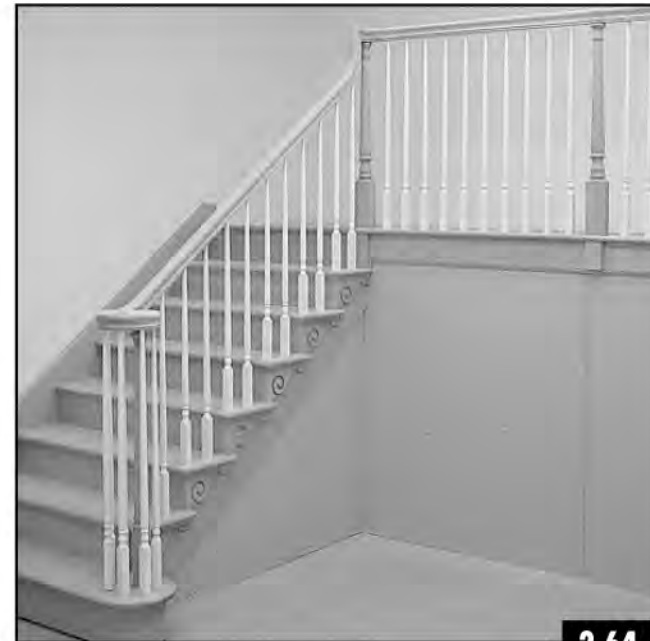

2-64

FITTING DEFINITIONS

FITTING ORIENTATION

Fitting orientation is determined from the bottom of the stair looking up. All fittings above are right-hand. **PHOTO 2-64.**



2-65

2-66

CAP VS. NO CAP

All fittings fall into two categories: (1) those designed and manufactured with a cap and (2) those manufactured without a cap. **PHOTO 2-65.** All fittings with caps have a 3/4" diameter hole bored in the under side of the cap to receive the top pin of the Over-the-Post newel while fittings without caps are designed to carry the baluster line through a transition without the use of a newel. **PHOTO 2-66.** Capped fittings are clearly identified in both the drawings and product descriptions in the Coffman Buyers Guide.

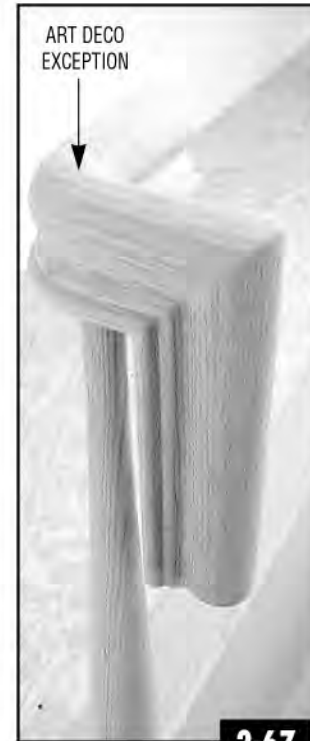

2-67

NOTE: The exception to the use of fittings with caps over all newels is Coffman's Art Deco family. The contemporary styling of this line necessitates the use of fittings without caps even where newels are used. Refer to Chapter 5, Page 8 for adjustments to newel placement. **PHOTO 2-67.**

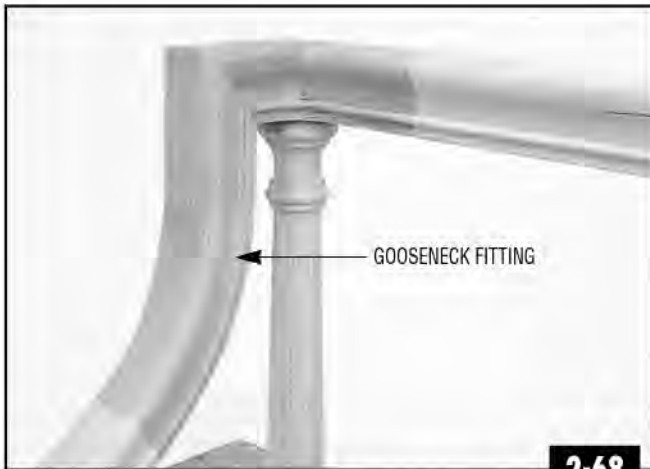

2-68

GOOSENECK FITTINGS

Gooseneck fittings are used to accommodate transitions in height and/or direction at intermediate and balcony landings. **PHOTO 2-68.**



2-69

ONE-RISE VS. TWO-RISE

Most goosenecks are offered in both one-rise and two-rise versions. **PHOTO 2-69.** The one-rise gooseneck is manufactured with the lower easing attached and is limited to use on stairs where the difference in rake rail height to balcony rail height is 4" (Example: 34" rake rail height to 38" balcony rail height). **DRAWING 2-70.** The corresponding two-rise gooseneck makes the same height and/or directional change as its one-rise counterpart but is shipped with the lower easing unattached. This versatile two-piece design allows the installer to trim or extend the straight section of the gooseneck to a height that will work in any situation. **PHOTO 2-71.** Two-rise goosenecks work in applications where the difference in rake rail height is less than 4" (Example: 34-1/2" to 38". SEE NOTE BELOW), greater than 4" (Example: 34" to 42"), or unknown at the time of ordering.

NOTE: It is recommended that a minimum difference of 4" between rake rail height and balcony rail height be kept on all Over-the-Post systems. The clamp nails used in the manufacturing of the goosenecks can interfere with the necessary cut line if less than 4" difference is maintained.

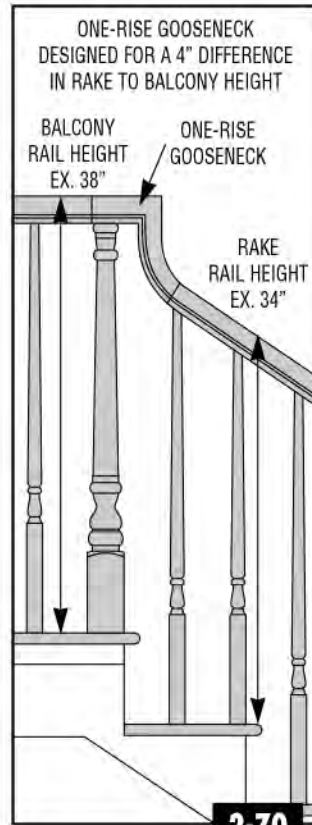

2-70



2-71

In addition to the prior applications listed, intermediate landings will always require a two-rise gooseneck. These reasons, coupled with the fact that it is sometimes very difficult to maintain an exact 4" difference in field conditions, make the recommendation of two-rise goosenecks the safe option in most Over-the-Post installations.

Suggested goosenecks for some common applications are listed below. **DRAWINGS 2-72.** See page 45 in the WM Coffman Buyer's Guide

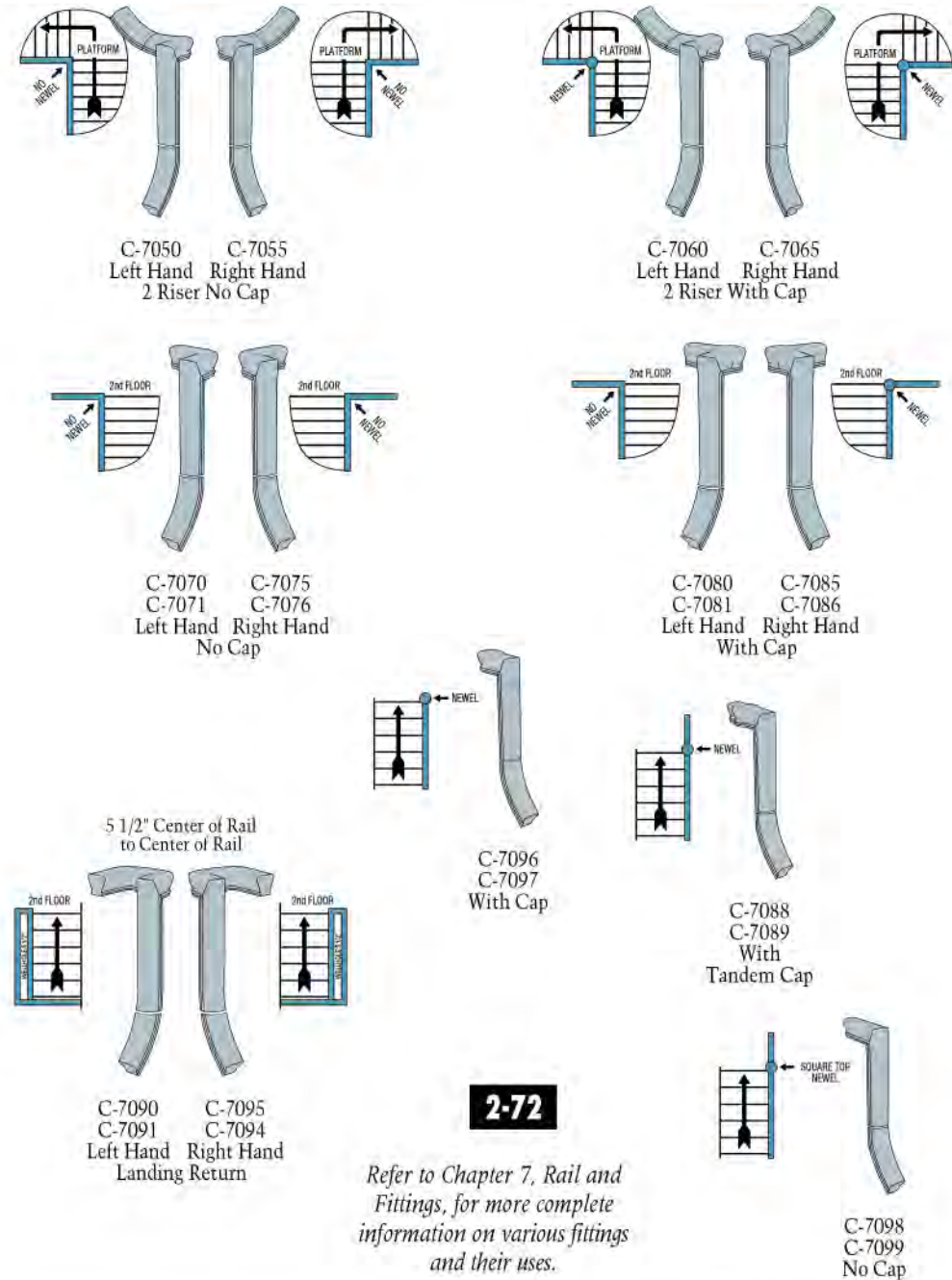

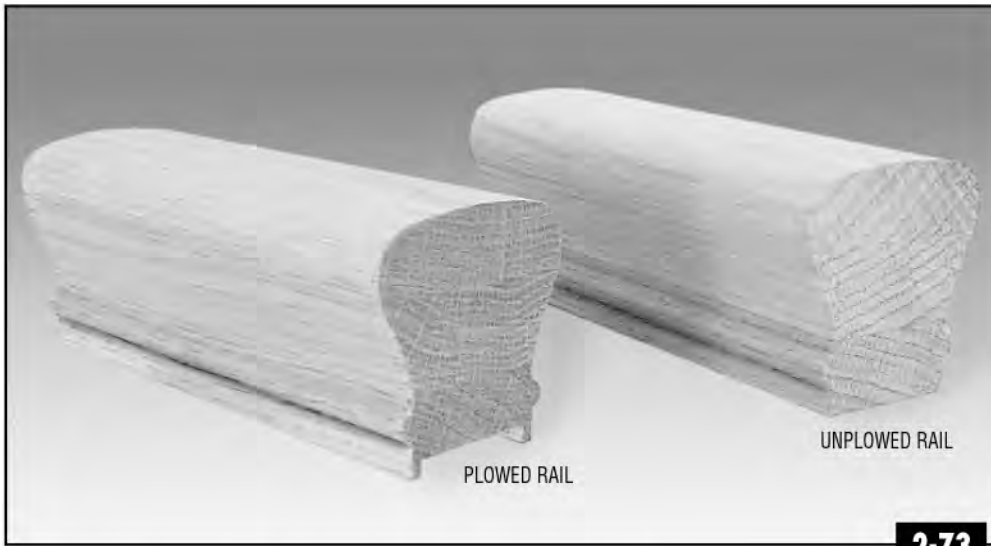

2-73

RAIL AND LINEAL BALUSTRADE COMPONENTS

Rail and lineal balustrade components, like other lineal products, are offered in even lengths from 4' to 16'.

For rake portions of the stair, measure along the slope of the stair or use the lineal formula:

Number of Treads x 13" (rounded up to the nearest even length).

Rail is offered in both a plain, unplowed version as well as a plowed version, determined by the type of baluster used (See Page 2-26). **PHOTO 2-73.**

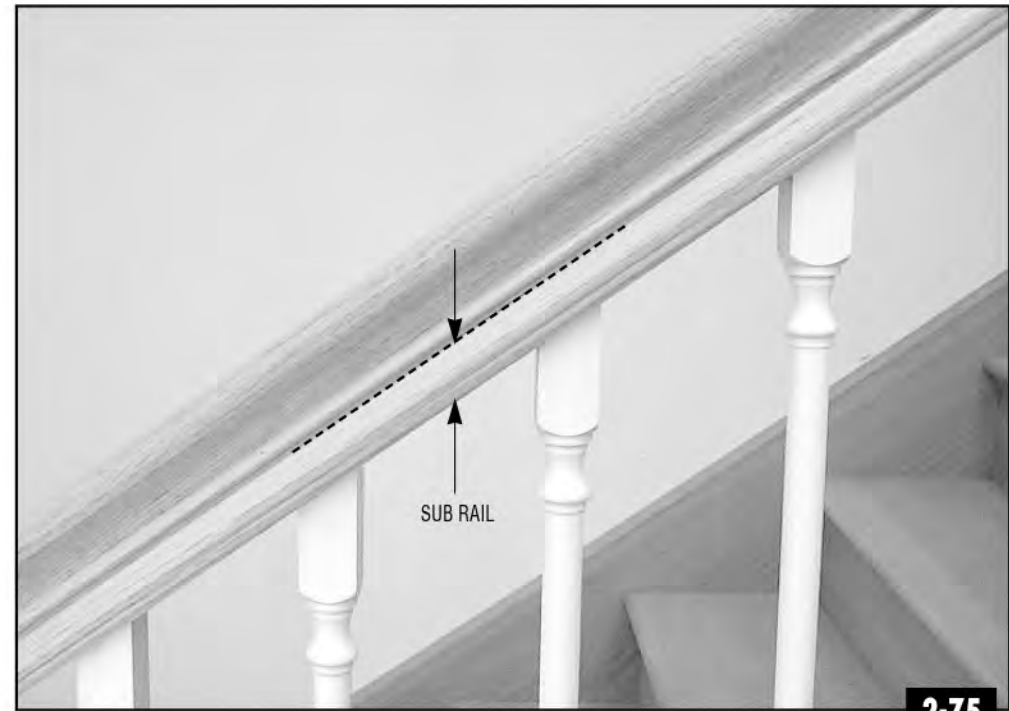

2-75

Sub rail is used under unplowed handrail with square top balusters in PTP systems to provide a more substantial look to the balustrade. **PHOTO 2-75.**

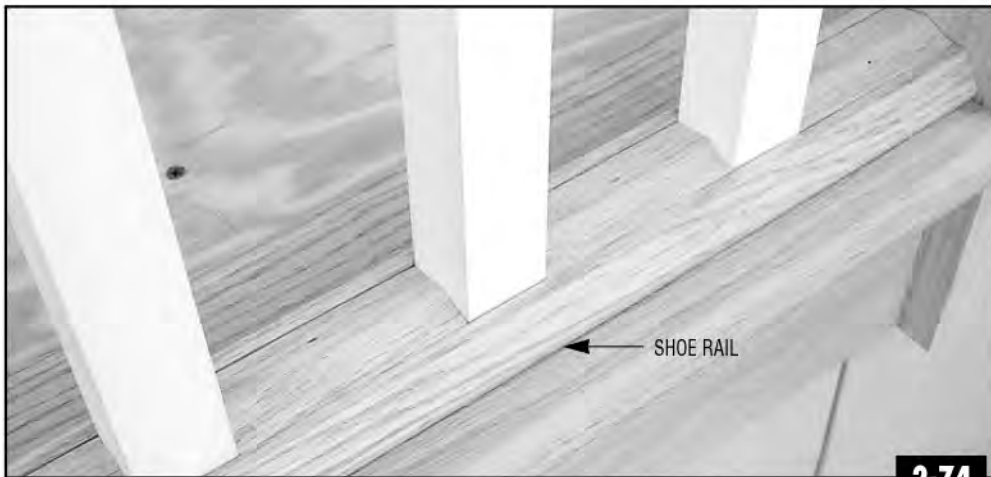

2-74

Shoe rail is a plowed moulding designed to accept the bottom of the baluster. **PHOTO 2-74.**

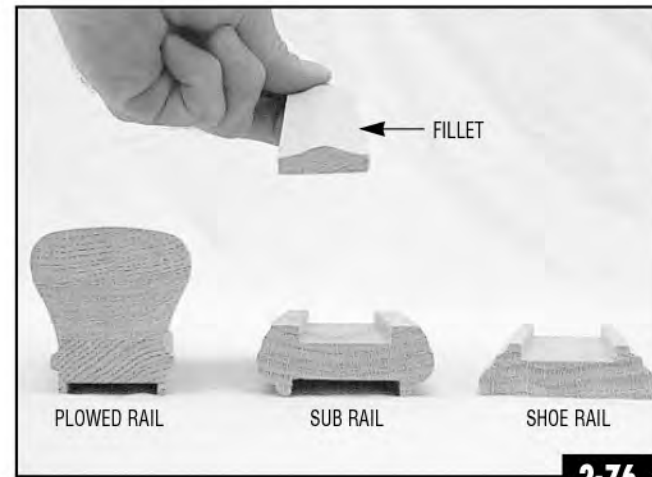

2-76



2-77

Fillet, a filler moulding that will be installed between the balusters in plowed rail and rail accessories, will need to be ordered at an approximate rate of 90% of the lineal rail product total. Example: A stair with 10' of plowed rail would require 9' of fillet. **PHOTO 2-76 and PHOTO 2-77.**

BALUSTERS

All balusters fall into one of the following two categories, pin top or square top.

PIN TOP

Pin top balusters have turned, round tops that will be inserted into holes drilled into unplowed handrail.

PHOTO 2-78 and **PHOTO 2-79.**

NOTE: Pin top baluster sizes are measured from the bottom of the baluster pin to the top of the baluster. Pin top balusters are also straight at the top of the baluster for a minimum of two inches to allow for trimming.

2-78



SQUARE TOP

Square top balusters have a turned portion, leaving a square upper and lower portion. Installation of square-top balusters will require a plowed handrail and fillet. **PHOTO 2-80** and **PHOTO 2-81.** It should be noted that while either of these baluster styles can be used in both Over-the-Post and Post-to-Post systems, square-top balusters used in Over-the-Post applications will require additional preparation as described in *Chapter 8, Pages 17-18.*

2-80



RAKE BALUSTER HEIGHTS

The stair's rake and balcony rail height, along with code considerations on baluster spacing, will determine the length and quantity of balusters required on any given job. **Table 2-82** lists the quantity and length of the balusters necessary for each rake application for a 34" rake rail height.

BALUSTER QUANTITY AND LENGTH (For 34" Rake Rail Height)

STARTING EASING	TURNOUT	VOLUTE	ASCENDING VOLUTE	VERTICAL VOLUTE
BALUSTERS UNDER STARTING FITTINGS				
QUANTITY - 1	QUANTITY - 2 C-7240, C-7245 QUANTITY - 1 C-7241, C-7246	QUANTITY - 6 1-1/4" SQUARE QUANTITY - 5 1-3/4" SQUARE	QUANTITY - 6 1-1/4" SQUARE QUANTITY - 5 1-3/4" SQUARE	QUANTITY - 1
LENGTH 39"	LENGTH 43"	LENGTH 41"	LENGTH 39"	LENGTH 39"
BALUSTERS ON TREADS				
FRONT BALUSTER - 36"	SECOND BALUSTER - 39"	THIRD BALUSTER (optional) - 41"		

2-82

Adjustments to rake rail heights can be accommodated on a 1:1 basis (See *Photo 2-50*). Examples: For a 36" rail height, simply add 2" to the given length and order the nearest baluster length (*rounding up if necessary*). For a 30" rake rail height, simply subtract 4" from the given length and order the nearest baluster length (*rounding up if necessary*).



BALCONY BALUSTER LENGTH



BALCONY BALUSTERS

Baluster length requirements for the balcony will match the balcony rail height. If an exact baluster length is not available, simply round up to the next available length. (Example: For a 38" balcony rail height, order a 39" baluster.) **PHOTO 2-83.**

MAXIMUM CENTER-TO-CENTER SPACING (Under 4" Sphere Rule)

	
1-1/4" BALUSTER SQUARE	1-3/4" BALUSTER SQUARE
4-1/2"	4-5/8"
	Exception: For 1-3/4" Pin Top Baluster with 5/8" diameter tops (i.e. C-5611) use: 4-1/2"

2-84

Spacing codes vary but generally fall under the 4" sphere rule explained in *Photo 2-7*. The dimensions listed are recommended center-to-center spacing measurements that will safely comply with this code.

TABLE 2-84.

To obtain the quantity of balusters for individual balcony runs, begin by dividing the length of the balcony run by the corresponding center-to-center spacing in Table 2-84 and rounding up. This figure will give you the number of spaces in the segment, which must be reduced by one to achieve the necessary number of balusters.

Number of Balusters

Per Balcony Segment =

$$(\text{Total Run} \div \text{Center-to-Center Spacing}) - 1$$

NOTE: Balcony balusters will always number one less than the spaces in a balcony section. Refer to *Chapter 5, Photos 14-20* for more complete information on baluster layout.

Repeat as necessary for additional balcony segments.

ROUGH STAIR



CHAPTER 3

ROUGH STAIR



A staircase is a permanent piece of furniture that is often a focal point in the consideration of the buying and selling of homes. A safe, aesthetic, and functional staircase depends heavily upon the attention given during the early design and layout stages of the stair body.



Considerations such as local building codes, options in stair design, and options in stair layout need to be carefully addressed before beginning any construction.

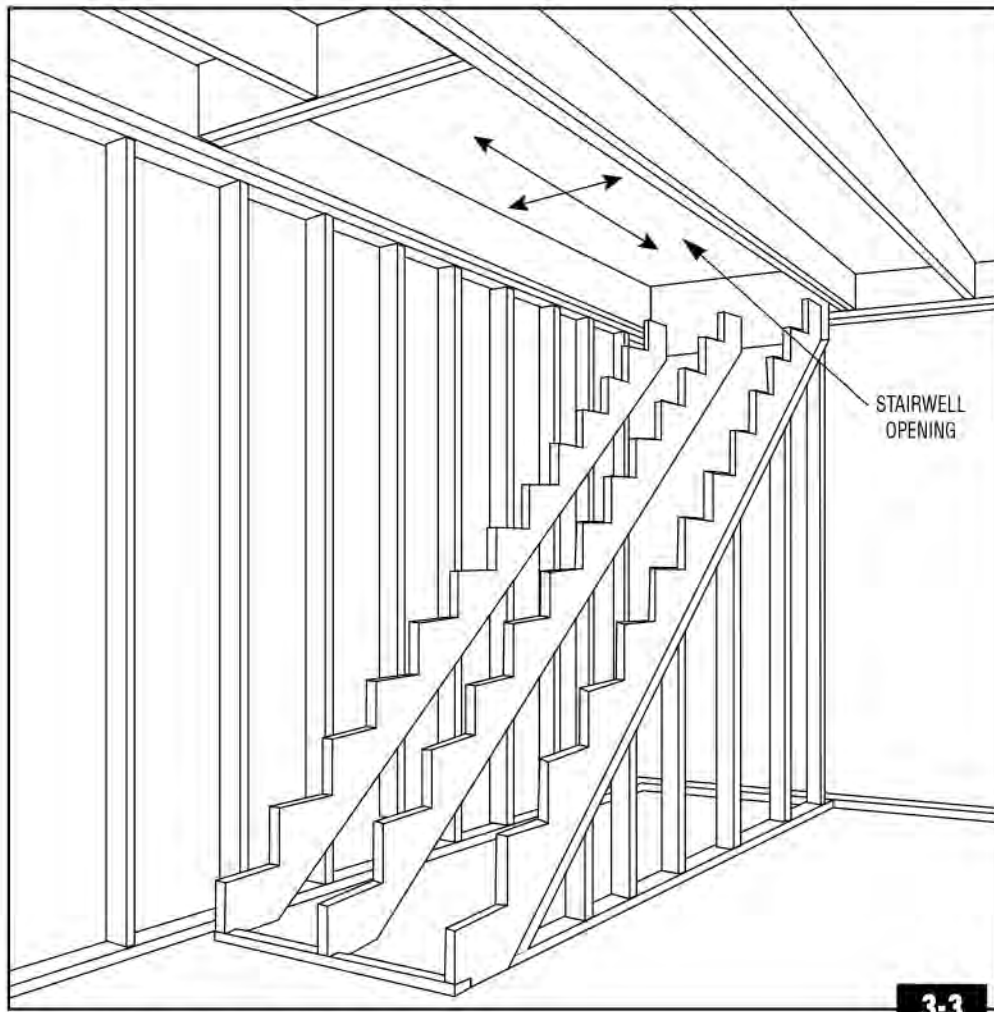

STAIRWELL OPENING

WIDTH

Local building codes will normally allow a minimum finished stairwell width of 36" (See Photo 2-10). The stairwell width opening of a properly built stair will be oversized in width to allow finished wall materials to be applied without infringing upon the desired width or local building code requirements. **DRAWING 3-3.**

LENGTH

The stairwell opening length should be planned to allow the proper headroom, which is a minimum 6'8" in most building codes. In most situations with 8' ceilings and an approximate 7-1/2" rise, the second floor header cannot extend further into the stair than the first tread without infringing into this headroom requirement. If your unit rise is less than 7-1/2" you may be able to shorten the well opening so that it falls just slightly onto the stair's second tread. However, whenever the floor plan permits, we recommend a well opening that extends as far as possible, preferably beyond the total run of the stair. A larger well opening will create a feeling of openness rather than confinement on the finished staircase.

NOTE: A feeling of confinement will also be true of stairwells that are closed in on both sides. Whenever possible remove or cut back one or both of these walls to add natural light.

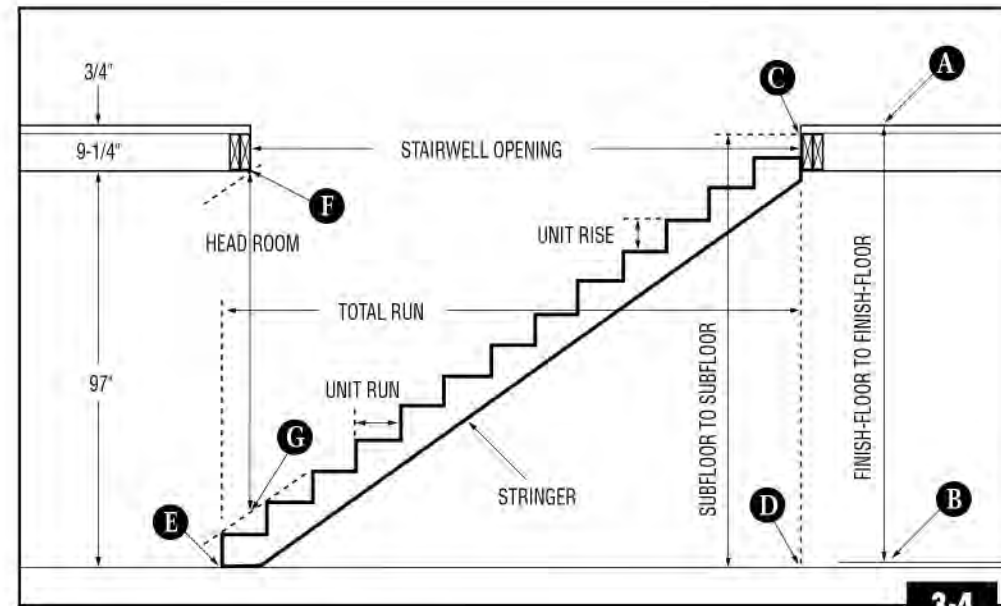

STAIR LAYOUT AND DESIGN

STRAIGHT-RUN STAIR

Stair layout for a safe and comfortable staircase begins with the understanding of the rise and run dimensions of the stair and their relationship to each other in creating a proper stair design. Although basic code parameters must be adhered to in the design process, several combinations of rise and run will normally be code compliant, leaving other considerations for a final rise to run ratio.

Human ergonomics must be considered when trying to design a "comfortable" stair. The design of the human body will tend to make people stand straighter and take shorter strides on a stair with a higher rise. On a stair with a short rise, a person will tend to lean forward and take a longer stride, normally requiring a longer tread. A stair with a rise of 7-1/2" and a tread run of 10" is generally considered "ideal" for most people. A simple ratio that can be used to determine the most comfortable layout suitable for your design constraints is listed below.

The sum of one rise plus one run should be between 17" and 18".

Layout and design will always begin with the one fixed dimension in the stair, subfloor to subfloor height. Refer to **Drawing 3-4** and measure the "total subfloor rise" (C-D) from subfloor to subfloor. In our example you will get 107" which is the sum of a 97" rough wall height, a 2 x10 floor joist at 9-1/4", and a 3/4" plywood subfloor. You will now need to know the thickness of the finished floor material for both floors to determine the total "finish-floor to finish-floor rise" (A-B). Add the thickness of the second floor finished material to the "total subfloor rise" and subtract the thickness of the first floor finish material. Example: Total subfloor rise 107" + 1/2" (second floor carpeting) - 3/4" (oak floor on first floor) = Finish-floor to finish-floor rise of 106-3/4".

See Drawing 3-4 for all reference points.

In most areas the maximum code allowable riser height is 7-3/4". However, a more comfortable stair will be in the range of 7-1/2". By dividing our finish-floor to finish-floor rise of 106.75" by 7-1/2", we find 14.23 as the recommended number of risers. We know we need a whole number of risers so we round 14.23 to 14 and divide that into our total rise of 106.75" to determine the "unit rise" to be 7.625", or 7-5/8".

In every straight section of stair there will always be one less tread than there are risers. We know the stair in this example will have 13 treads. Most codes ask for a minimum "unit run" of 10", allowing us to calculate the total run of the stair by multiplying the unit run times the number of treads. $10 \times 13 =$ total run of 130". Bring a plumb mark down from the end of the stairwell marked (C) to the subfloor (D). From point (D) measure the total run of the stair (130" in this example) to point (E); this will be where the stair carriage begins its ascent to the second floor.

NOTE: To determine if the stair fits into design constraints of your house (i.e. doorways), you must account for the 3/4" riser, the tread overhang, the thickness of the door casings, and either the thickness of the finished wall material covering the header (See Photo 3-16) or an optional 3/4" hanger board (See Photo 3-26). **PHOTO 3-5.**

You can now check your headroom (See Photo 2-9) by bringing a plumb line down from point (F) to point (G). Every 10" from point (E) toward point (D) will add a tread and 7-5/8" of rise. If point (F) extends further than 10" from point (E), the second floor header will fall over the second tread, which, as stated above, will usually not meet the 6'8" headroom requirement.

Now that you have seen these results there are some simple changes you could try to see if a more desirable result is possible. Divide your finish floor rise by 15 instead of 14 used in our earlier example. This will give you a rise per tread of 7-1/8" instead of 7-5/8", a reduction of 1/2" per tread. We have 14 treads and we will leave the run at 10", creating a total run (D) to (E) of 140" (10 x 14). You can now check your headroom as before. Remember the shorter you make the rise and/or the longer you make the run, the shallower or less steep the stair will be. Keeping code considerations in mind, you may try a number of variations at this point until you have a combination that satisfies the constraints that you have to work within.



3-5

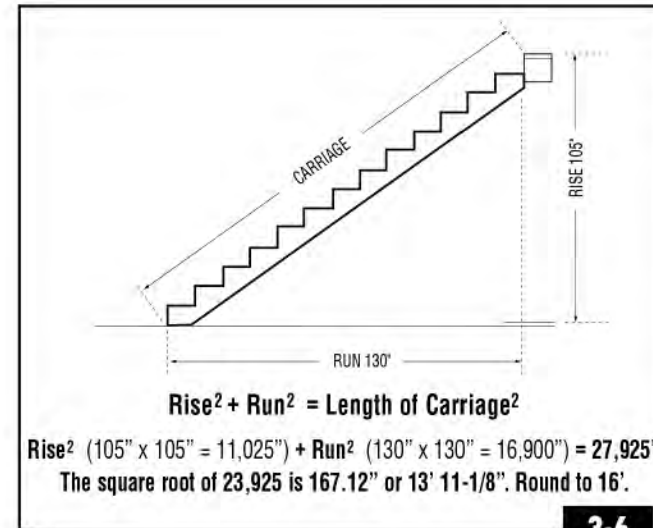

3-6



3-7

LAYOUT AND CUTTING THE STAIR CARRIAGE

From this point forward in our installation instructions, we will use a 14 rise stair with a rise of 7-1/2" and a run of 10", allowing you to see the measurements in our photographs clearly.

With the finish-floor to finish-floor rise of 105" (7-1/2" x 14) and the total run of 130" (10" x 13) the length of the carriage can be calculated using the Pythagorean theorem ($A^2 + B^2 = C^2$). **DRAWING 3-6.** The result is so close to 14 ft. we would recommend using a 16 ft. piece to allow a waste factor for variables such as end splits, etc. The length of the carriage can also be obtained by taking a rough measurement from point (E) up to point (C) (See Drawing 3-4), arriving at the same necessary length of 16 ft.

A 2 x 12 is the recommended framing stock for a full stair. One 2 x 12 stair carriage every 16" of stair width is recommended to eliminate bounce in the stair and reduce the opportunity for squeaks. The outside carriage of stairs that are closed underneath should be supported with a conventional 2 x 4 stud wall. **PHOTO 3-7.** Stairs that are open underneath will require a double carriage on the open side or sides. It is best to hand pick these 2 x 12's as you need them as straight and knot free as possible.

Begin layout of your stair carriage by attaching angle gauges, or stair gauges, to a framing square at points representing the rise and run of your stair.

PHOTO 3-8.

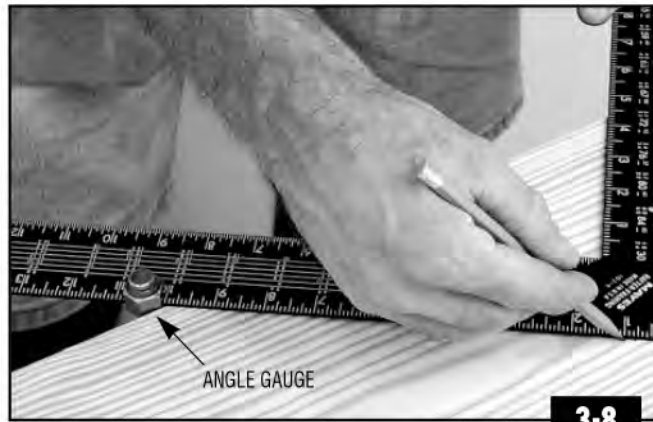

Starting at the bottom with a full rise, lay out each tread and riser combination onto the top of the carriage until you have 13 runs and 14 rises. Because the edges of the carriage stock are rounded, care must be taken to not let your repeated layout gradually grow over the length of the carriage. **PHOTO 3-9.**



The last riser mark at the top of the stair represents the side of the well opening and will be extended downward for your top cut. **PHOTO 3-10.**

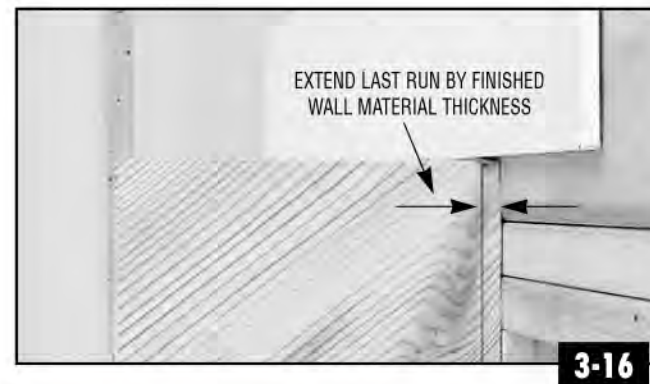
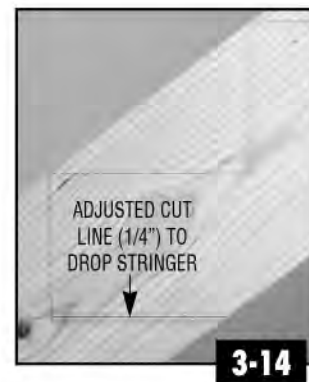
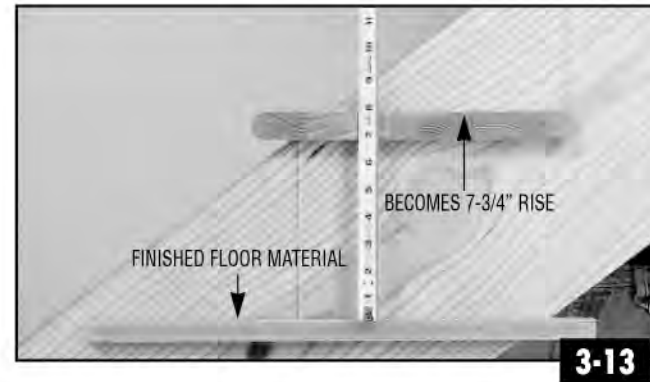
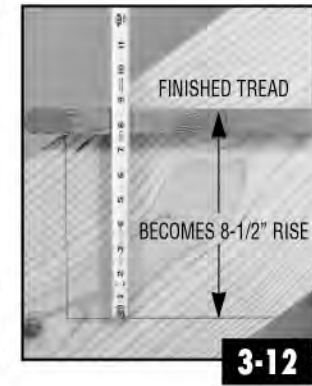
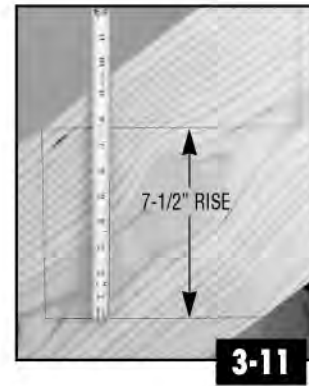
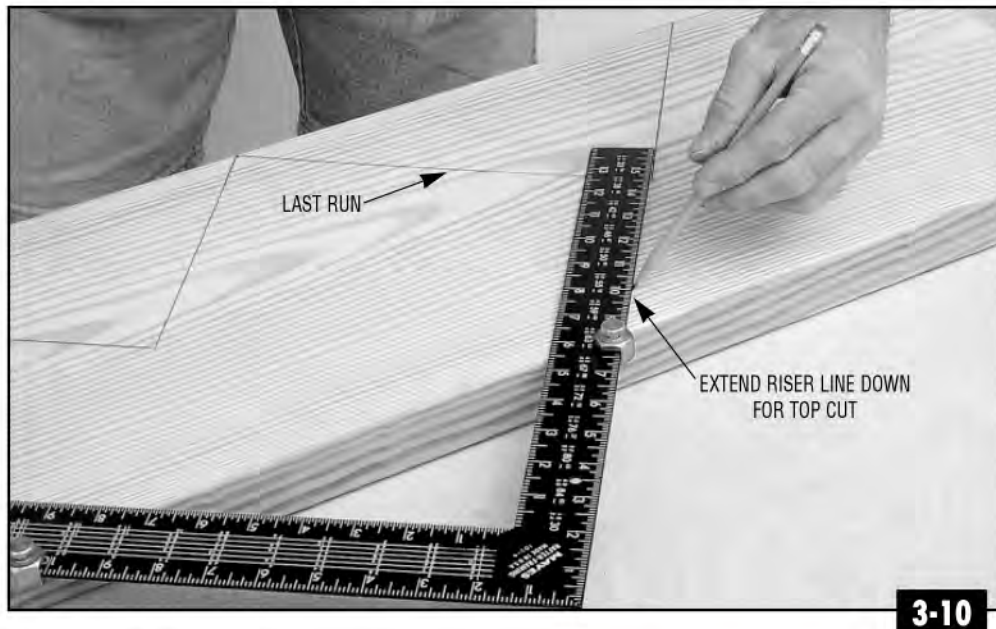

DROPPING THE CARRIAGE

In order to make the top and bottom rise the same as the intermediate rises you have to “drop the carriage.” This phrase refers to the trimming of the bottom of the first riser by the difference in thickness between the tread and the first floor finished material, assuring that each rise going up the stair remains the same after the finished materials are installed. The first 7-1/2” rise, **PHOTO 3-11**, if left unadjusted, becomes 8-1/2” once the finished 1” treads are applied. **PHOTO 3-12.**

When the 3/4” flooring is installed on the first floor, the first rise then becomes 7-3/4”. **PHOTO 3-13.** The 1/4” increase over the required 7-1/2” necessary rise must be trimmed from the bottom of the carriage, effectively “dropping the carriage”. **PHOTO 3-14.**

Since we initially laid out our carriage using the finish-floor to finish-floor rise, this “dropping of the carriage” will automatically adjust the measurement at the top of the stairs. When the last tread and the finished floor material on the second floor are installed the last rise will be the same as all the other rises. **PHOTO 3-15.**

To ensure that all the runs are equal, the last run at the top of the stair must be extended by the thickness of the finished wall material. In the photo, 1/2” has been added to the run for the thickness of the finished sheetrock. **PHOTO 3-16.**

Once the carriage is laid out, use a circular saw to cut on the waste side of the line until the blade reaches the intersecting line. **PHOTO 3-17.** The rest of the cut is made with a handsaw. **PHOTO 3-18.** A horizontal notch in the bottom front edge of the carriage (to receive a 2 x 4 kick board) and a vertical notch in the top back edge (to receive a 2 x 4 ledger board) will complete the carriage. **PHOTO 3-19.**

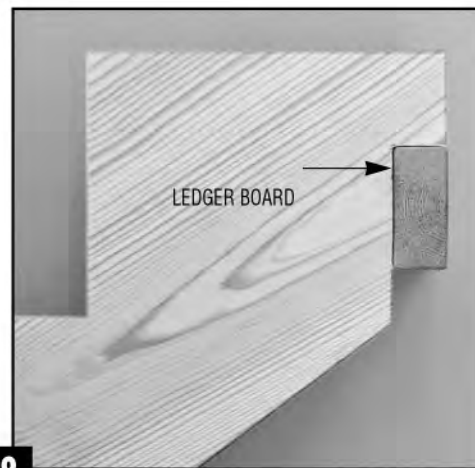
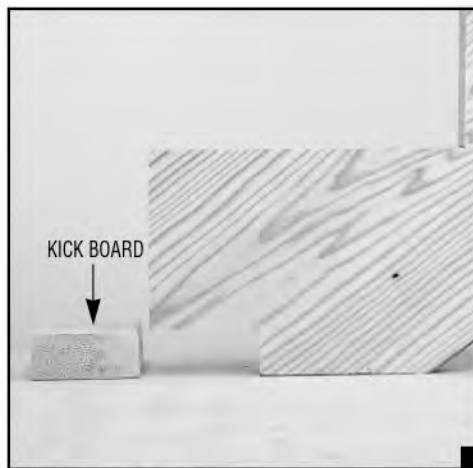
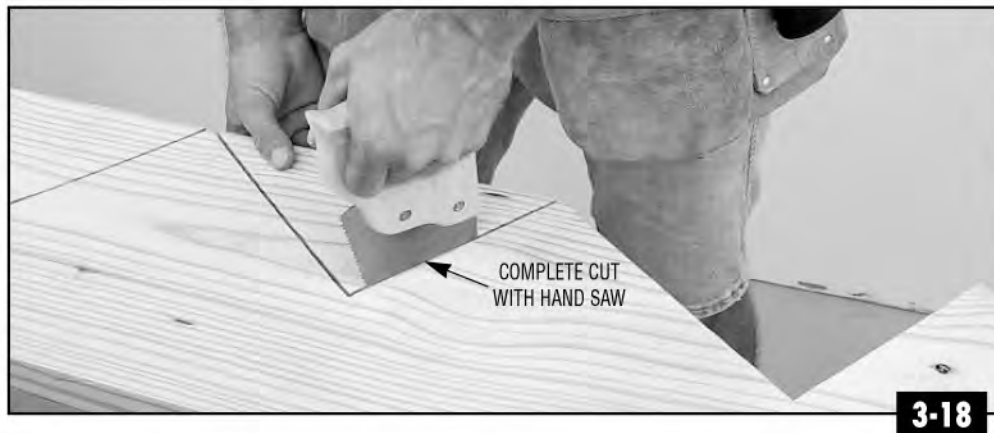

Temporarily set one carriage in place, adjust the top to its proper height considering the tread thickness and the finish floor thickness, and mark the location of the header. A torpedo level may be used on any run cut to verify accuracy. **PHOTO 3-20.**

At the same time mark the side of the stairwell or stud wall for the carriage location so you won't have to relocate it again later. Marks should be placed above the last run and along the bottom of the carriage. **PHOTO 3-21.**

From the mark on the side of the well opening extend a level line across the header. **PHOTO 3-22.** If a ledger board is to be installed it should be attached into the header at this time.

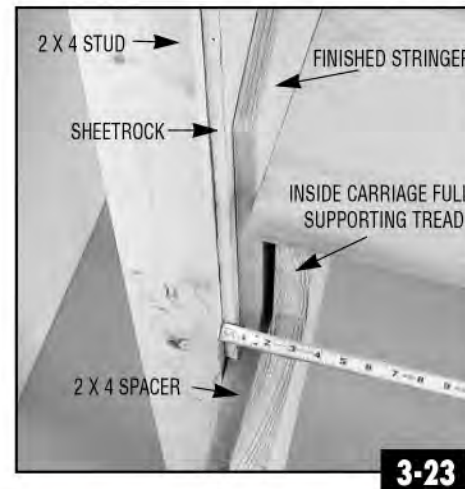
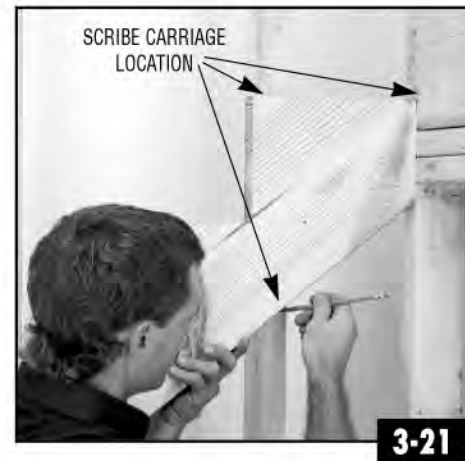

With the locations marked we are now ready to install the carriages. If a carriage is to be mounted against a wall it is best to put a 2 x 4 spacer between the stud wall and the carriage. This spacer will allow the sheetrock and the skirtboard to slide down behind the carriage, eliminating the need to make the sawtooth cuts in those materials while allowing full bearing of the tread on the carriage. **PHOTO 3-23.**



The spacer can be nailed to the stud wall using the marks previously made in *Photo 3-21* to assure the correct angle. The inside carriage can then be nailed into the spacer. Open side carriages and a centered middle carriage (or *equally spaced middle carriages*) can then be nailed conventionally. Use a level as a final check to ensure proper positioning of the rough carriages. **PHOTO 3-24.**

To complete the carriage installation, slide the kickboard under the bottom front edge of the carriages, line the carriages parallel and nail conventionally. **PHOTO 3-25.**



KICKBOARD

3-25

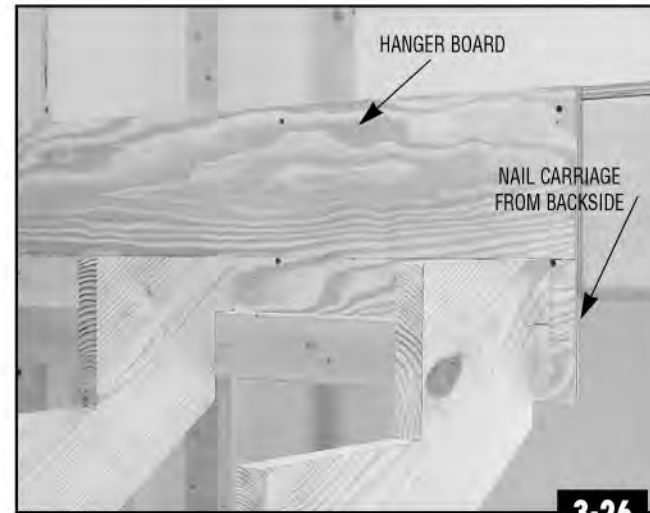

3-26

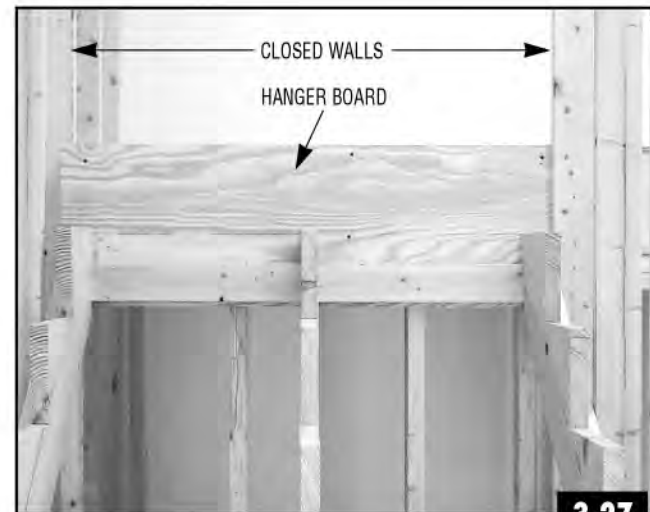

3-27



3-28

CARRIAGE ATTACHMENT OPTIONS

HANGER BOARD

For stairs that are enclosed at the second floor by the well opening or stud walls, the use of a hanger board is an easy, quick, and secure mounting option. Hanger boards are usually made out of 3/4" plywood and fit the width of the opening from the bottom of the carriage to the top of the subfloor. Measure from the top of the second floor subfloor down to the bottom heel of the carriage to give you height of the hanger board.

PHOTO 3-26.

Nails driven through the back of the hanger board into the 2 x 12 boards will secure the carriages.

NOTE: Because of the difficulty in tying finished wall materials (i.e. sheetrock) into a hanger board, it is recommended that this option be utilized only when the top of the stair is enclosed. **PHOTO 3-27.**

NOTCHED CARRIAGE

A third option is to cut a notch in the top of the rough carriage that will accept the bottom of the header. This option should always be accompanied with the use of commercially available mechanical fasteners. **PHOTO 3-28.**

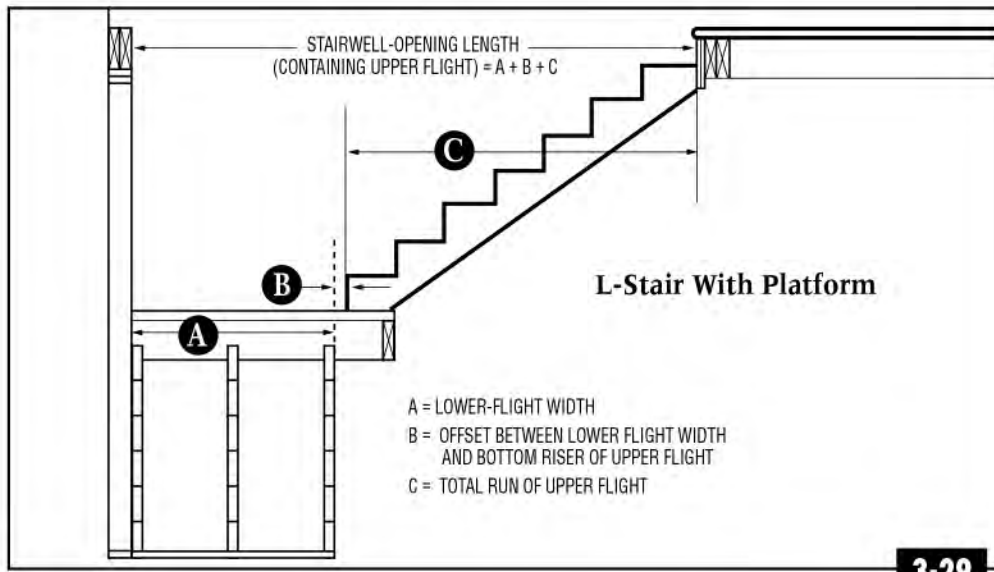

3-29

ANGLED STAIRS

L-shaped, U-shaped and T-shaped stairs can all be figured in the same manner as described earlier with the height of the platform set to achieve an increment of the finish floor rise. The thickness of the treads and finished floor materials will have to be considered.

NOTE: It is not unusual for the finished floor material thickness on a platform to be different than the treads. If this happens you will have to adjust the height of the platform so that once the finished materials are installed all the rises will be equal. *Example:* Treads are 1", the platform will have 3/4" oak flooring, and the individual rise of the stair is 7-1/2". A platform for this stair, set at 1/4" over an increment of the finished rise, (i.e. 15-1/4", 22-3/4", 30-1/4", etc.) will give the correct results once the finished materials are installed. **PHOTO 3-30.**

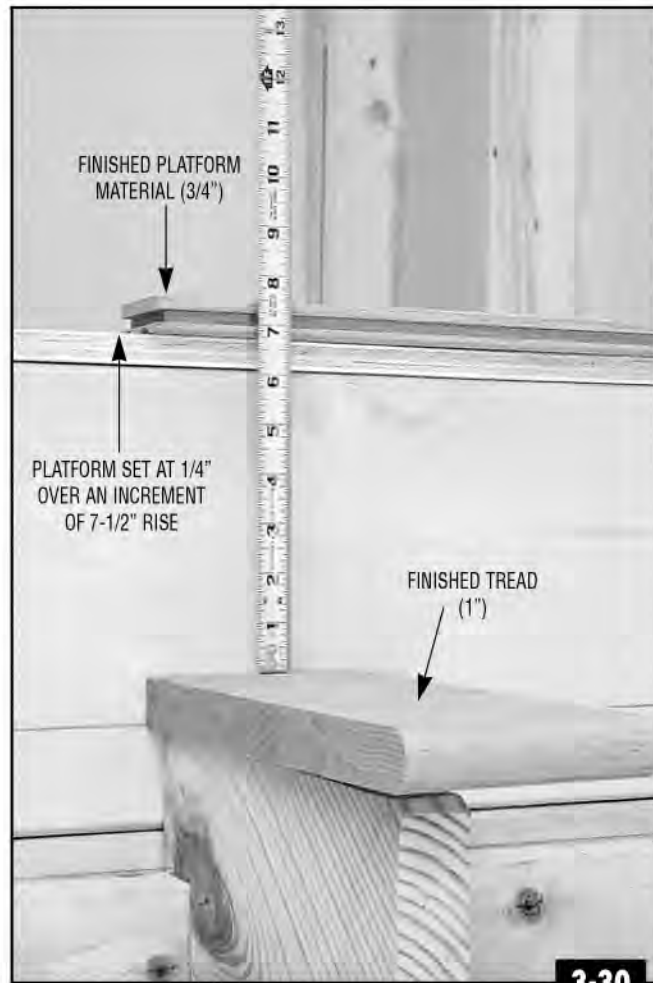

3-30



3-31

A typical platform will be rectangular with the platform extended approximately 12" on the side where the second flight leads off to the second floor. **PHOTO 3-31.**

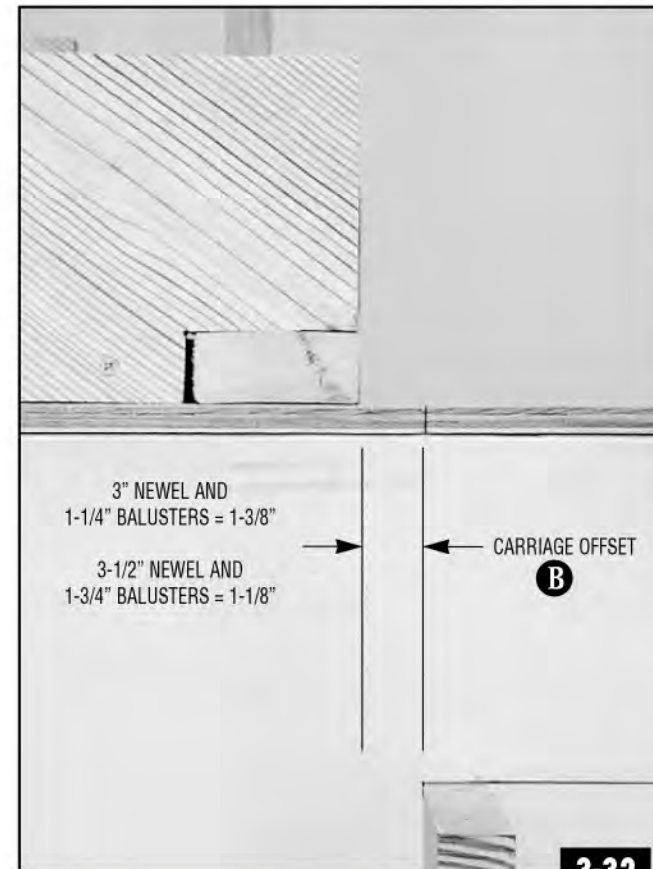

3-32

It is very important that the offset (B) is correct so that the center line of the balusters on each flight intersects at the center of a properly placed newel. To achieve this offset, you must design a stair with an individual run that will total the necessary horizontal distance (C) from the second floor header to the platform or adjust the width (A) of the stair (See drawing 3-29).

NOTE: If you are using a 3" newel and 1-1/4" balusters the offset is 1-3/8". If you are using a 3-1/2" newel and 1-3/4" balusters the offset will be 1-1/8". Refer to *Chapter 5, Balustrade Layout*, for a more detailed discussion of baluster center lines. **PHOTO 3-32.**



BLOCKING

With the rough carriage installed, temporary treads are normally nailed in place until the sheetrock is installed and the finished stair installation is started. The last thing to do before leaving the rough stair is install blocking to aid in the secure installation of handrail brackets, rosettes, half newels and newels.

PHOTO 3-33.

WM Coffman®

STAIR BODY

4

CHAPTER 4

Stair Body

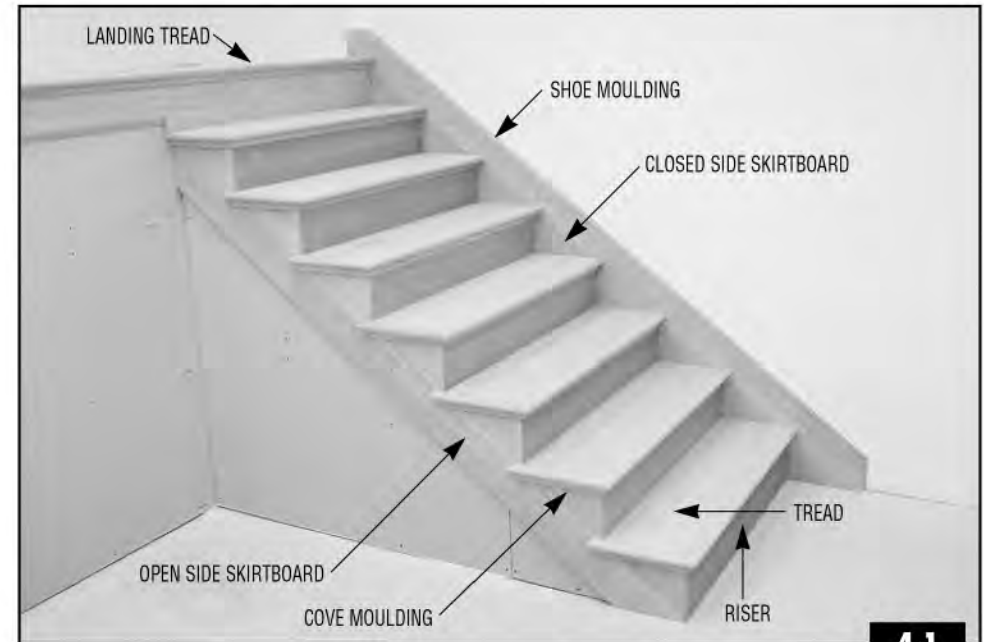

The Stair Body is most easily described as all parts that are below the walking surface of the stair. It consists of treads, risers, skirtboard, landing tread, cove moulding, and shoe moulding, as well as optional decorative tread brackets and starting steps.

SKIRTBOARDS

Both closed side and open side skirtboard layout can be marked with the use of angle gauges and a framing square (See Chapter 3, Page 6). Begin by marking out the necessary number of rise and run dimensions for your stair.

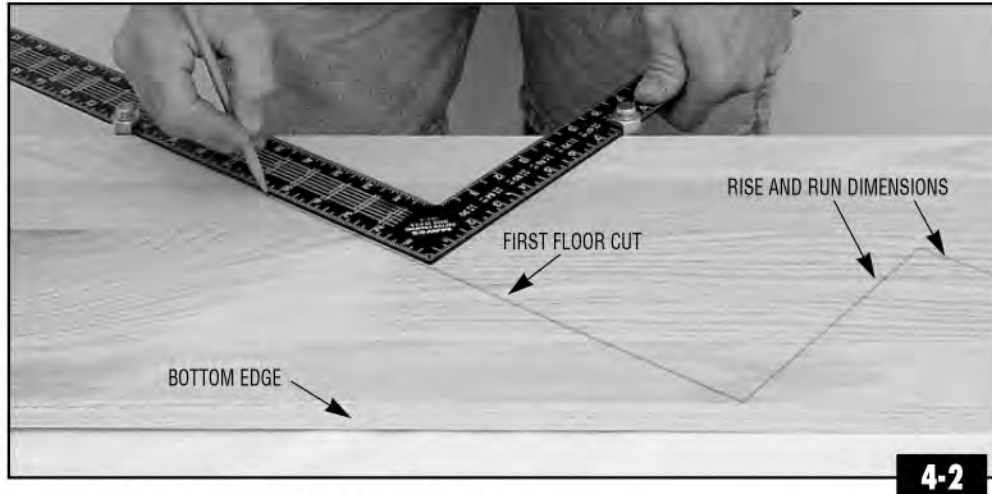

4-2

CLOSED SIDE SKIRTBOARD LAYOUT

At the bottom of a closed side skirtboard, use a framing square to extend a line from the bottom of the first rise parallel to the tread lines above. This will be the first floor cut.

PHOTO 4-2.

NOTE: If the first rise on the rough carriage was adjusted for the thickness of the finished floor materials (See Photo 3-14), you must make the same adjustment to the first rise of the skirtboard.

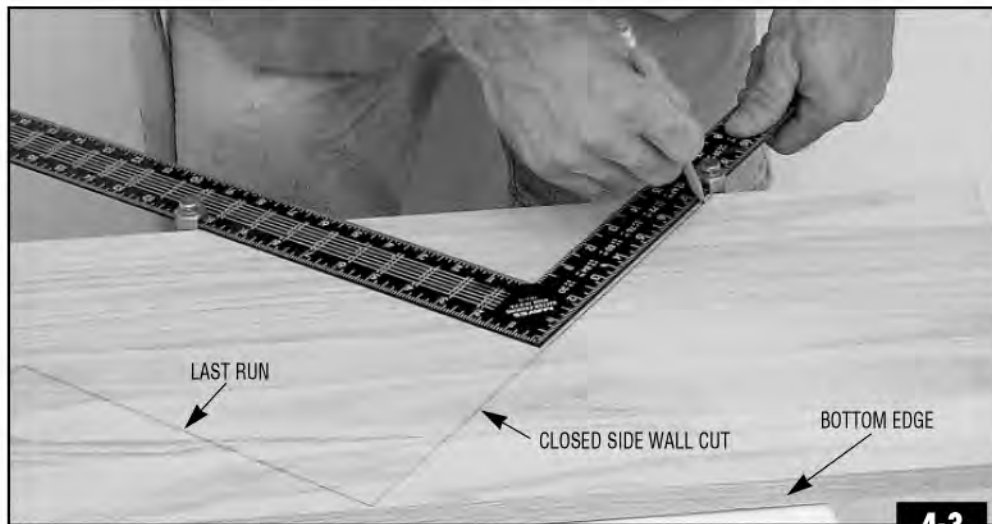

4-3

At the top of the closed side skirtboard extend the last riser line (representing the second floor header) across the board. This mark will be your second floor closed side wall cut.

PHOTO 4-3.

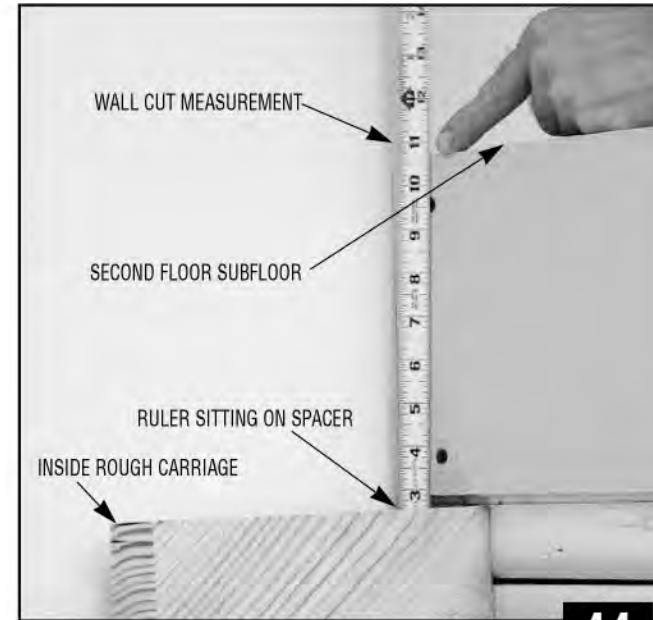

4-4

Measure the distance from the top of the spacer behind the rough carriage (See Photo 3-23) to the top of the second floor subfloor.

PHOTO 4-4.

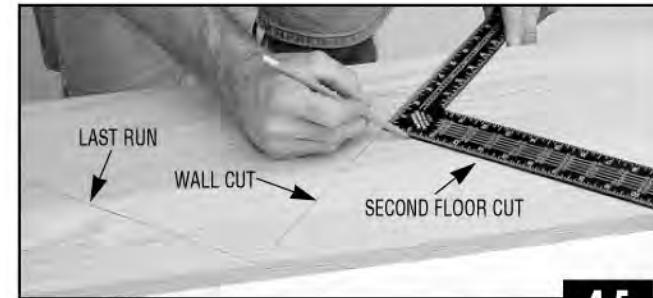

4-5

Transfer this measurement to the extended top riser line and use the framing square to extend the line parallel to the tread lines below it. This will be your second floor cut (See Photo 4-13).

PHOTO 4-5.



4-6

After making the first floor cut, wall cut, and second floor cut, place the skirtboard between the sheetrock and the rough carriage. *NOTE:* Sawtooth cuts are not necessary through the length of the skirtboard when a spacer has been installed between the stud wall and the carriage (See Photo 3-23). Check to make sure that the floor and wall cuts are accurate and that the amount of skirtboard shown above the rough carriage is equal from the top of the stair to the bottom.

PHOTO 4-6.

To finish the closed side skirtboard, mark and cut the bottom to tie into the first floor base moulding.
PHOTO 4-7.

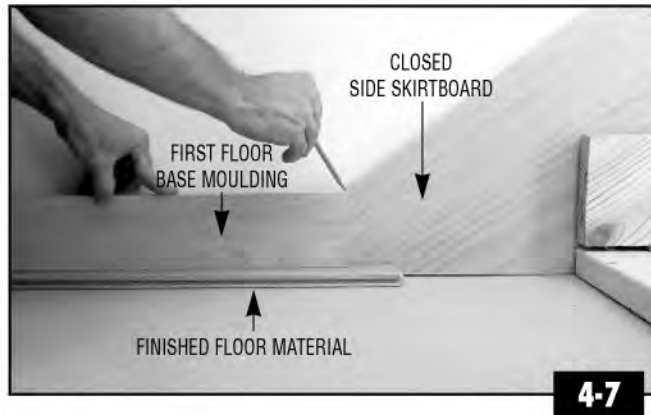

Cut the top of the closed side skirtboard to extend to the back of the landing tread at a height that ties into the second floor base moulding.
PHOTO 4-8.

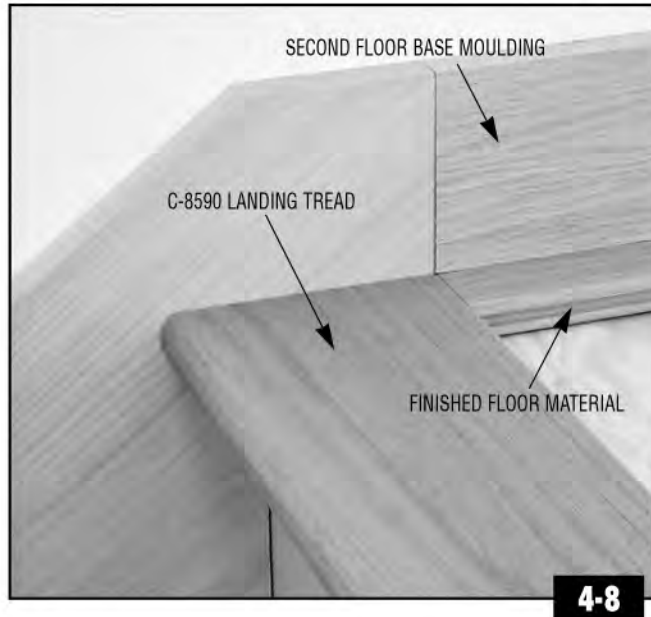

An optional cut is to remove the thickness of the finished floor material from the bottom of the floor cut in order that the finish floor can be inserted under the skirtboard.
PHOTO 4-9.

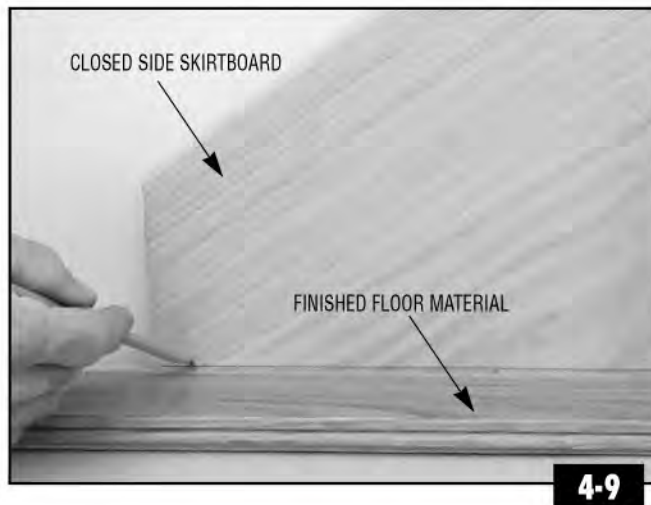

The closed side skirtboard can now be permanently installed to the sheetrocked wall.

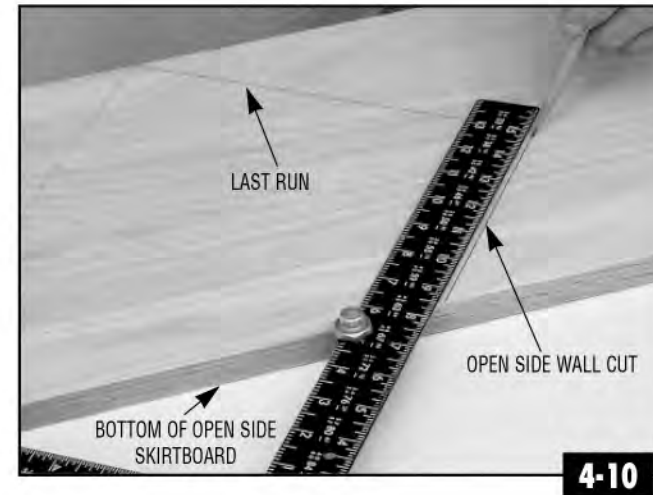

OPEN SIDE SKIRTBOARD LAYOUT

The layout and marking of the first floor cut on the open side skirtboard closely resembles the instructions for closed side skirtboards. The differences arise at the top riser line that was extended upward on the closed side skirtboard. This line must be extended downward to create the wall cut. **PHOTO 4-10.**



With the floor cut and wall cut completed and checked for accuracy, use bar clamps to temporarily attach the open side skirtboard to the sheetrock covering the outside rough carriage.
PHOTO 4-11.



A line should then be scribed at the bottom of the skirtboard to help assure correct placement after all cuts have been made.
PHOTO 4-12.

NOTE: Only cut the floor and wall cuts at this time. The marking and cutting of the individual rise and run marks will follow later in the installation process (See Chapter 4, Page 8).

OPTIONAL USE OF SKIRTBOARD LAYOUT TEMPLATE

An optional method of marking the closed and open side skirtboards is with the use of a skirtboard layout template. These templates are easily made at the job site and will account for rough carriages that do not contain exact rise and run dimensions throughout the length of the carriage.

For closed side skirtboards, create a short template using angle gauges and a framing square set to the rise and run of your stair to make a first floor cut, a wall cut, and a second floor cut (See Chapter 4, Pages 2-3). A reference line should be placed at the top of the template in the center of the board. **PHOTO 4-13.**

Place the template on the spacer behind the rough carriage at the bottom of the stair and place a mark on the wall at the reference line. Next note any angle adjustments that need to be made. **PHOTO 4-14.**

Lay the template on the skirtboard, scribe the first floor cut line, adjust by the distance just noted, and transfer the reference line to the top of the skirtboard. **PHOTO 4-15.**

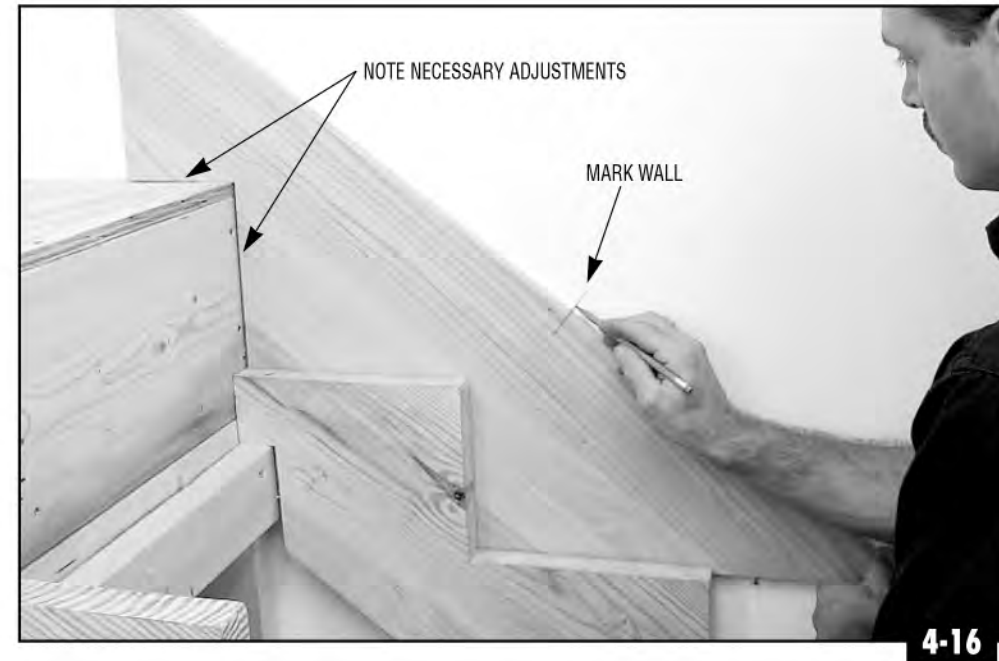
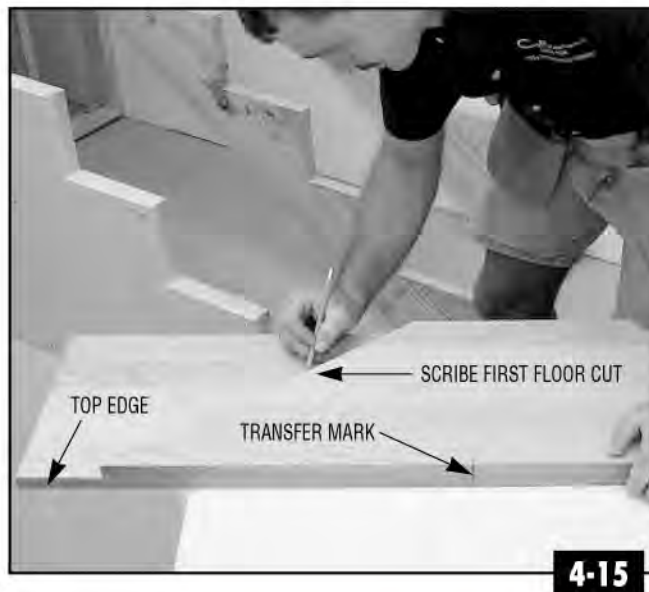
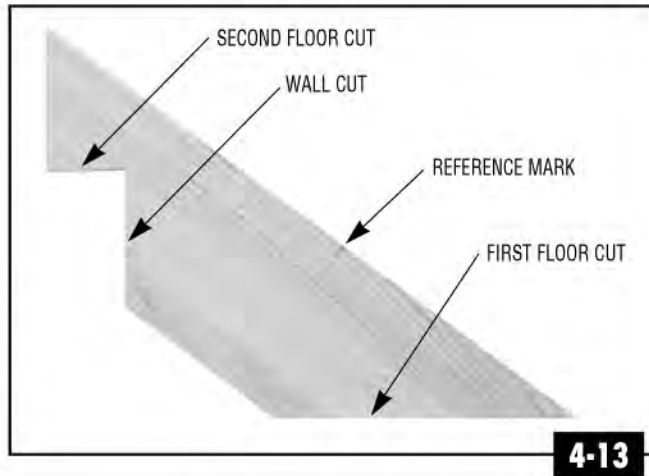

Repeat the process at the top of the stair by marking the reference line on the wall and by noting any angle or space adjustments needed between the wall cut and the header and the second floor cut and the second floor. **PHOTO 4-16.** Measure the distance between the reference marks on the wall and transfer the measurement to the skirtboard from the previous mark (See Photo 4-15). Align the template on the mark and scribe the wall and second floor cuts. **PHOTO 4-17.**

A second short template with a wall cut at the top can be used for open side skirtboards.

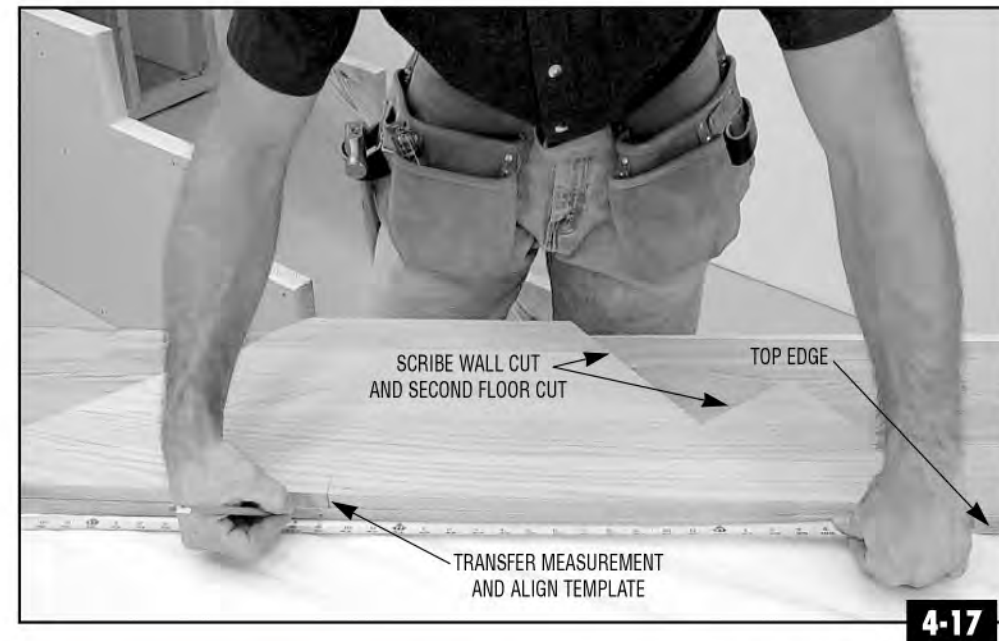

CUTTING OF OPEN SIDE SKIRTBOARD

The next step for an open side skirtboard will be the marking and cutting of each individual rise and run. For a more finished appearance, the skirtboard should be mitered to the risers. The easiest and most efficient way to mark for this cut is with the use of a marking jig. A skirtboard marking jig can be made from any 4" wide by 18" board that is the same thickness as the riser stock, which is normally 3/4". Simply cut a 7/8" notch into the center of the jig approximately 12" long. A handle shaped into the upper side will ease handling. **PHOTO 4-18.**

Slide the jig over the top of the skirtboard and push up against the rise of the outside rough carriage. **PHOTO 4-19.** A mark at the front side of the jig on the outside face of the skirtboard will correctly miter into your riser. Remember to cut on the waste side of the line, as you would rather be slightly long than short. **PHOTO 4-20.**

As you work your way up the stair you can also use the jig to mark the tread cuts. **PHOTO 4-21.**



Marking Jig is No Longer Available at WM Coffman. Simply mark the Skirtboard on the face of the Rough Carriage.

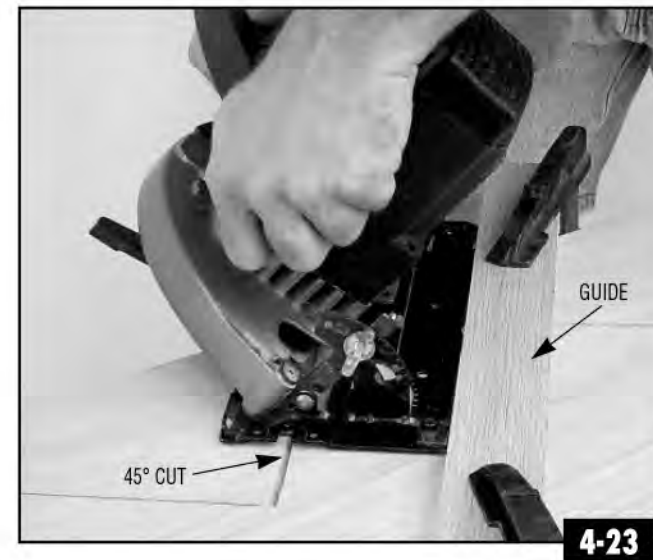
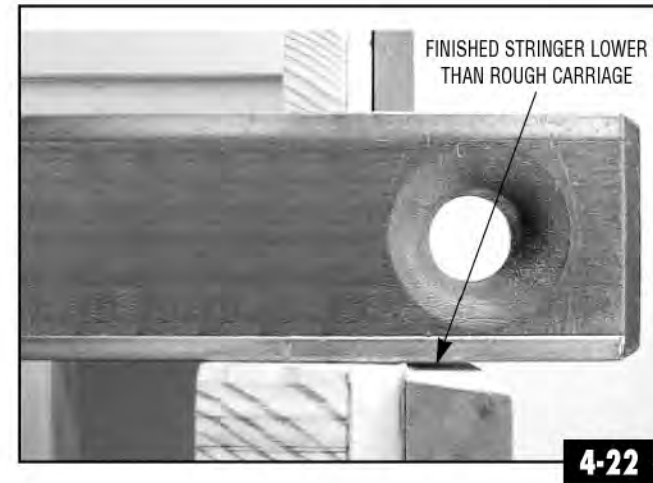

Because any slight crack between bottom of the tread and the top of the carriage will be hidden by the cove moulding (See Photo 4-55), we suggest that you cut along the inside of the tread line when making this final cut. This will allow the rough carriage to carry the load of the treads. **PHOTO 4-22.**

To cut the riser line, use either a circular or jig saw to make a 45° cut on the waste side of your line. Because most standard power saws tilt in only one direction, left hand stairs will require special saws that tilt both left and right. If power saws are used, you may want to clamp a guide onto the stringer to assist in getting a clean, straight cut. **PHOTO 4-23.**

After all riser and tread cuts have been made, temporarily attach the stringer back to the wall using the marks that were previously made on the sheetrock. Before attaching permanently, double-check the accuracy of your cuts with a scrap riser that has been mitered. **PHOTO 4-24.**

USE OF DECORATIVE TREAD BRACKETS

When using Coffman's decorative tread brackets (C-8028 or C-8029), the riser mark must be adjusted on the skirtboard by the thickness of the 1/4" bracket to allow the bracket to be mitered. **PHOTO 4-25.**

Each riser line can be manually moved into the stair by 1/4" or a skirtboard marking jig planed to the thickness of the riser stock less the thickness of the bracket ($3/4" - 1/4" = 1/2"$) can be used (See Chapter 4, Page 8).

To prepare the bracket for installation, cut a 45° miter onto the riser edge. **PHOTO 4-26.** Temporarily position two brackets in place and mark the back of the lower bracket to align with the drop of the bracket above. **PHOTO 4-27.**

Trim the brackets to the necessary height and install with carpenter's glue and finish nails. **PHOTO 4-28.**

NOTE: Because any crack between the bottom of the tread and the top of the bracket will be concealed by the cove moulding (See Photo 4-55), it is sometimes easier to achieve a better miter at the skirtboard/riser joint when using a decorative tread bracket. This fact, coupled with the desire by some homeowners for a more decorative finished stair, makes tread brackets an option that should be considered on every job.

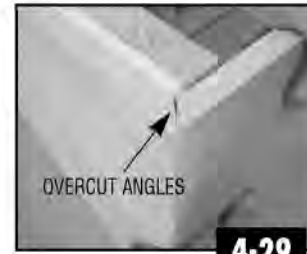
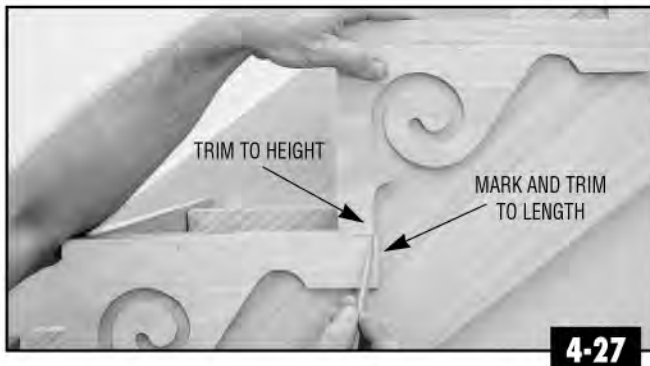
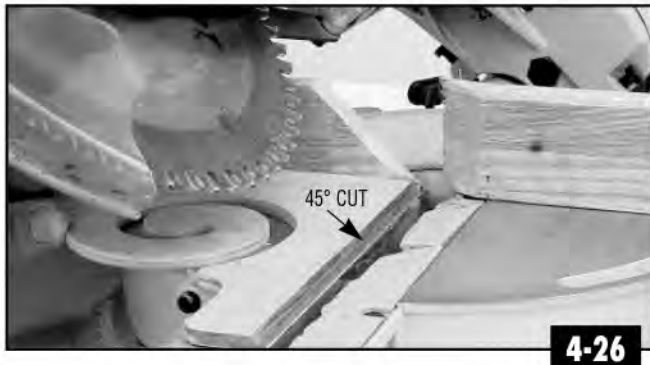

RISERS

With the skirtboards attached, you can now begin to install the risers. If necessary, rip the risers to a height that is slightly shorter than the total rise. Like the open side skirtboard earlier (See Photo 4-22), this will allow the rough carriages to bear the load of treads and will also be hidden by the cove moulding. On open stairways, it is usually easier to pre-fit the closed side of the riser and then trim the mitered open side. Over cut all angles to aid in installation. Plan on making several cuts to allow you to adjust the mitered end of the riser until it fits perfectly into the skirtboard. **PHOTO 4-29.**

On closed stairways, a scrap piece of riser, cut shorter than the stair opening, can be used to find the correct angle cut for each side of the riser. Simply trim one side of the scrap riser until the proper angle is found and transfer this cut to the finished riser. Find the angle for the other side, measure the opening, and apply the cut at the proper location to the other side of the finished riser. Some filing may be necessary.

NOTE: It is critical to the newel installation process that the first riser, any riser below an intermediate landing, and the last riser be plumb. This step will ensure a plumb newel which will lead to a tight finished joint between the notched newel and the riser, a secure installation of the newel, and an easier installation of the rail systems that follow. **PHOTO 4-30.**

When all risers have been pre-fit, they should be nailed or screwed into the rough carriages. Use carpenter's glue or construction adhesive on the mitered joint and secure with small finish nails from both directions. **PHOTO 4-31.**

NOTE: If the upper and lower nails or screws are placed within 3/4" of the top of the riser and within 1" of the bottom of the riser, they will be hidden by the cove moulding and finished tread. **PHOTO 4-32.**

The last riser on any straight flight of stairs will be installed to the header and must be checked for any bowing that will result in a crack between the back of the tread and the riser. Check the fit with a tread, shim the riser to fit, and apply securely with construction adhesive. **PHOTO 4-33.** Remember that the riser must stay plumb at the newel location to aid in landing or balcony newel installation (See Photo 4-30).

After the risers are installed, you are now ready to pre-fit the first tread or starting step.

STARTING STEPS

Coffman starting steps are shipped complete with the starting riser, starting tread, and all necessary shoe and cove mouldings. The curved end pieces of moulding are shaped into one laminated piece to ease the installation process and to remove the unsightly joint common to two-piece curved mouldings. **PHOTO 4-34.**

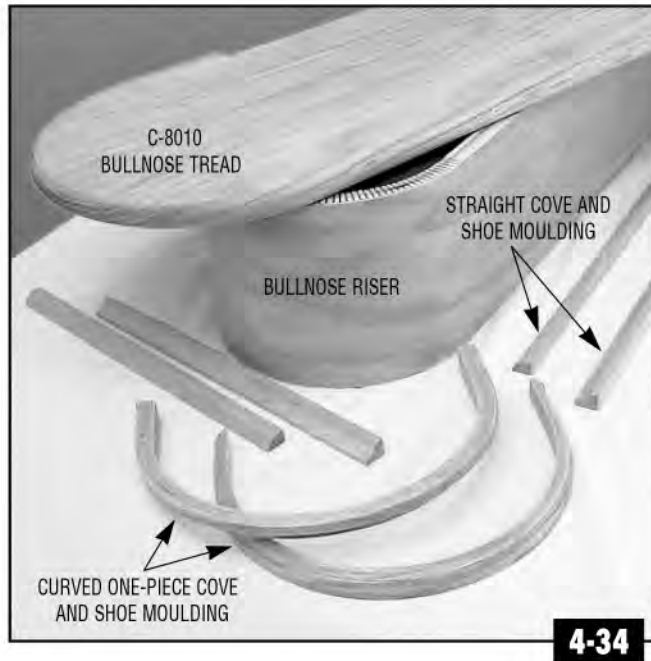

Because the first rise may be shorter than the remaining rises on a stair (See Chapter 3, Page 7), it is often necessary to rip the bent riser of the starting step. Set the tablesaw at the necessary width and depth. Begin by pushing the flat portion of the starting riser through the saw. **PHOTO 4-35.**



Rotate the bent portion of the riser through the blade, **PHOTO 4-36,** and continue to push through as you come out the straight section at the back of the riser. **PHOTO 4-37.**



NOTE: Because of the riser core blocks, stairs with a shorter than average rise may require that you trim both sides to achieve the necessary height.



When using doweled starting newels, the bullnose tread and riser of the starting step must have the starting newel attached before being installed. Installation of the tread/riser/starting newel combination is described more fully in Chapter 6, Pages 2-4. **PHOTO 4-38.**

Undoweled, square bottom newels will be attached only to the starting tread, with the starting riser installed separately (See Chapter 6, Page 6).

Although it is recommended that the starting riser rest solidly on the floor, it is not uncommon for the starting step to be raised off the floor the thickness of the finished floor material. In these cases, be certain to place a shim between the bottom core block of the bent riser and the floor for added support under the starting newel. **PHOTO 4-39.**

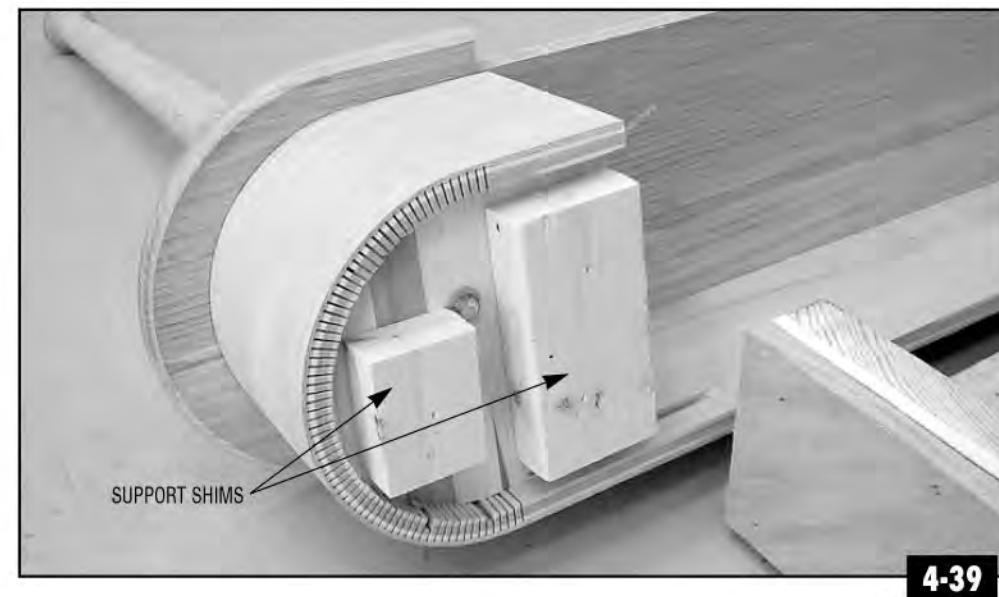



4-40



4-41



4-42

TREADS

On open stairs, cut the closed side of the tread until the proper angle is achieved against the closed side skirtboard and trim until the mitered return portion fits snugly to the outside skirtboard. Some filing may be required to achieve a custom, finished installation. **PHOTO 4-40.** *NOTE:* The width of a mitered return tread may need to be adjusted to create a code compliant overhang (*i.e. a 10" run and an 11-1/2" tread would not meet the maximum allowable overhang of 1-1/4" set by many national codes*). To do so, rip the tread on a tablesaw to the mitered return joint and complete the cut with a handsaw or jigsaw. **PHOTO 4-41.** If this leaves the portion of the return that wraps around the skirtboard too long, cut to length and reshape with sanders or a router equipped with a 1/2" radius roundover bit. **PHOTO 4-42.**



4-43

When all the treads are pre-fit, begin final installation by installing the first tread or starting step/starting newel combination. The use of construction adhesive is strongly recommended on all wood-to-wood connections. **PHOTO 4-43.**

NOTE: Check Over-the-Post starting newels with a level and shim the starting step as needed. **PHOTO 4-44.**

Treads for closed stairways can be cut in the same manner as closed risers (See Chapter 4, Page 11).



4-44



4-45



4-46

Nail or screw the tread into the rough carriages and into the top of the riser along the front of the tread. **PHOTO 4-45.** A tread nailing jig, notched to 1-1/2" deep and 1-1/4" tall, can be slid over the nosing to simplify the nailing of the tread into the top of the riser. **PHOTO 4-46.**

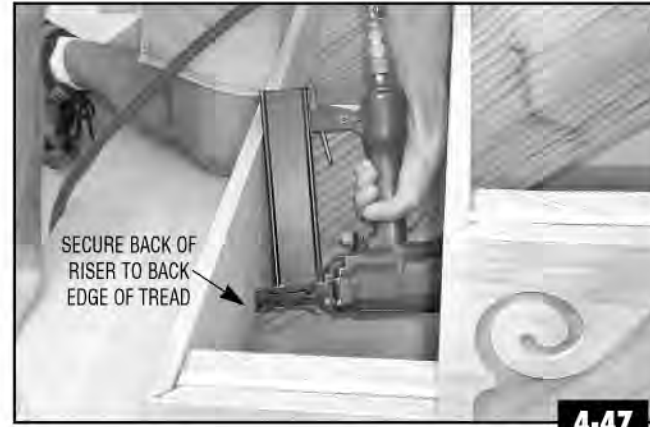

4-47

To minimize squeaks and ensure a tight joint between the back of the tread and the riser, nail or screw the back of the riser into the back edge of the tread. **PHOTO 4-47.**

If the underside of the stair is not accessible, you must now "glue block" the first tread and riser before installing the second tread. Glue blocks are approximately 4" blocks, square or triangular, that can be made at the job site from any scrap, lightweight lumber. These blocks, with carpenter's glue applied to two sides, should be installed at every possible wood-to-wood contact point on the underside of the stair. Glue blocks should tie the riser to the rough carriage, the tread to the rough carriage, the tread to the riser, and in the case of the first riser, the riser to the kick board. This critical step will ensure a solid, squeakless stair built for a lifetime of use. **PHOTOS 4-48, 4-49 and 4-50.** Repeat this process until the last tread is applied.

NOTE: The top tread on stairs that cannot be accessed from underneath cannot be glue blocked. Use generous applications of construction adhesive and nail or screw liberally to account for lack of glue blocks. Support blocking can be added to the side of the rough carriages to increase surface contact for gluing.



4-48



4-49



4-50

APPLYING MITERED RETURN NOSING

To assemble a returned tread in the field, order a Coffman C-8080-13 Return Nosing for each returned tread on your job.

To begin installation, cut a 45° miter into the C-8080-13 Return Nosing at a length that will create the correct overhang onto the skirtboard. With the nosing against the side of the skirtboard, align the front of the 45° point at the front of the tread and mark for the necessary cut. **PHOTO 4-51.**

Cut out with a sliding miter saw and jig saw, apply carpenter's glue, and permanently attach with two finish nails through the side of the nosing. **PHOTO 4-52.**

This method of installation can be duplicated for either single or double returned treads.

Install finished returned tread using standard installation techniques. **PHOTO 4-53.**

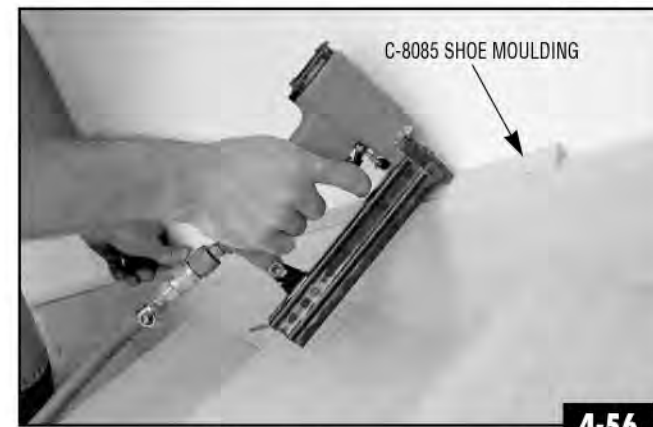
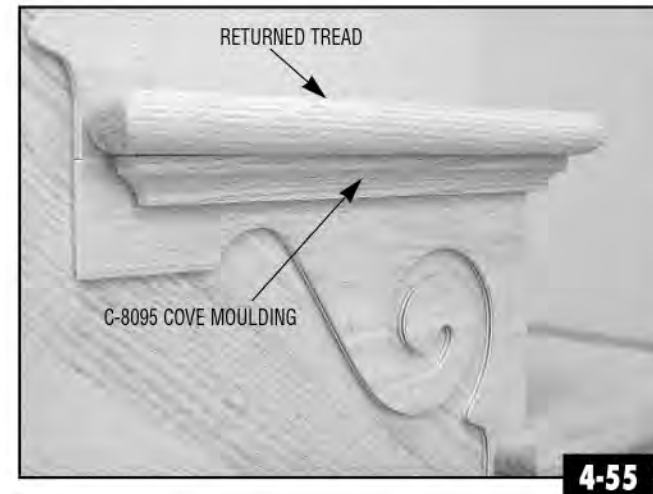
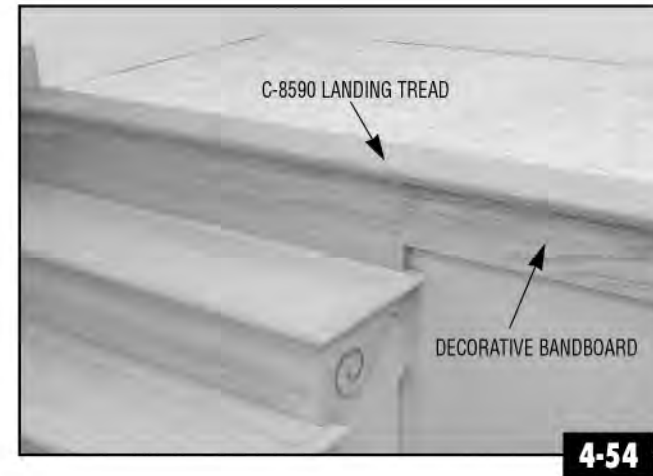
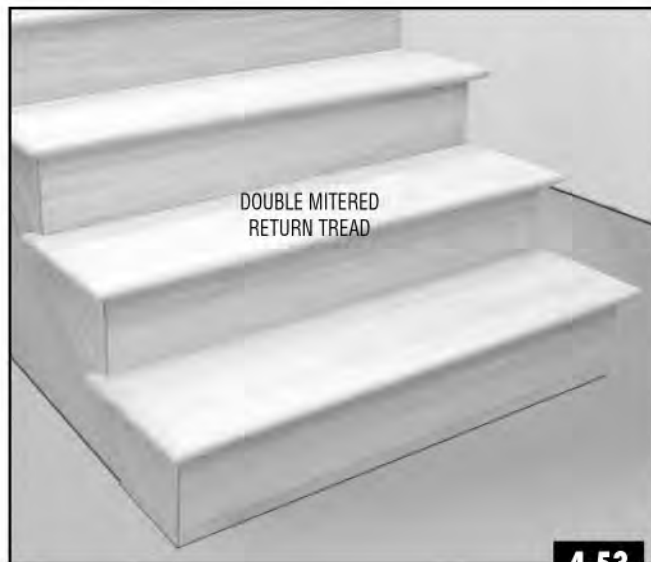
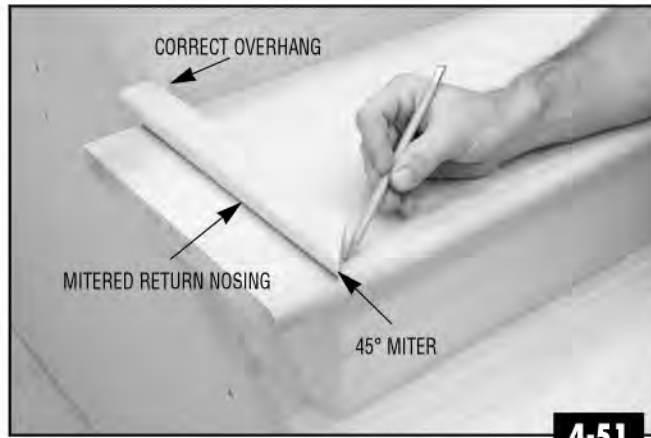

LANDING TREAD

Coffman landing tread is offered in both 3-1/2" widths (C-8090) and 5-1/4" widths (C-8590). The wider C-8590 will allow for a greater diversity of installation options and is recommended in most situations (See Chapter 5, *Balustrade Layout*). Apply at all landings and along all balcony portions of your stair with construction adhesive and nails or screws. Some installations will require the use of a decorative bandboard under the landing tread along the edge of the balcony **PHOTO 4-54.** The tread nailing jig (See *Photo 4-46*) can also be used to aid in nailing the landing tread into the center of the bandboard.

TRIMMING THE STAIR BODY

To complete the body portion of the stair, all that remains is the cove moulding (C-8095) and the shoe moulding (C-8085) that will be used to trim the stair. Cove moulding will be installed under the nosings of the front and sides of the treads and under all of the landing tread in the stair. The back of the side piece of cove moulding under the return portion of the tread should be mitered to length. **PHOTO 4-55.** Shoe moulding will be installed on top of the closed side finished skirtboard, underneath the open skirtboard and bandboards and along the bottom of the first riser. **PHOTO 4-56.**

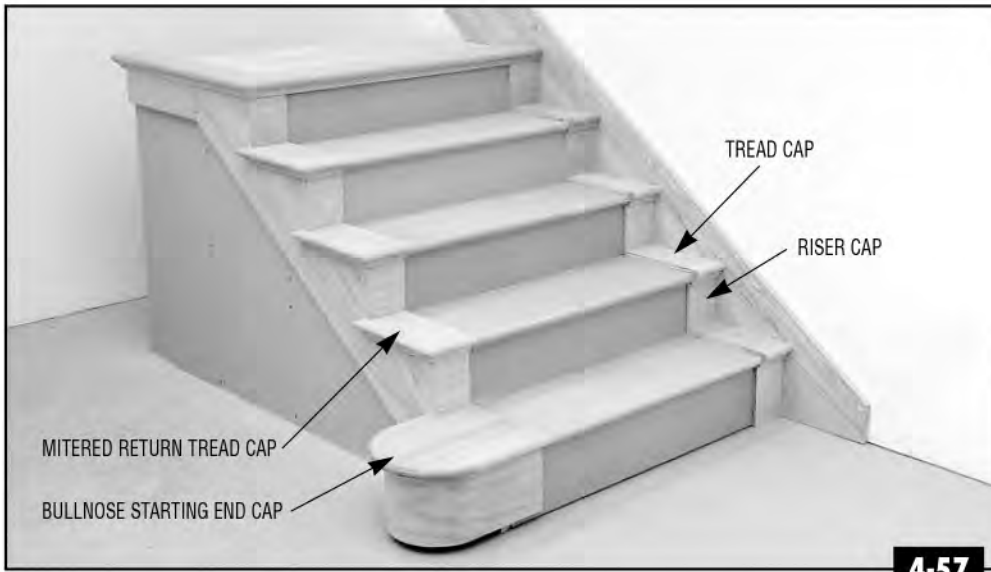

TREAD AND RISER CAPS

Coffman tread and riser caps, including bullnose starting end caps, can be used as an economic alternative to full treads and risers when using a carpet runner in the center of the stair. **PHOTO 4-57.**

Carpet-grade subtreads and subrisers will first have to be installed on the rough carriages. Subtreads should be nosed on the front to allow the carpet to roll over the front edge of the tread and ripped to a depth that will allow an approximate 1" overhang. Notches should be cut into the overhang to match the width of the caps. **PHOTO 4-58.**

Install subtread using construction adhesive and screws. You are now ready to install the tread and riser caps.

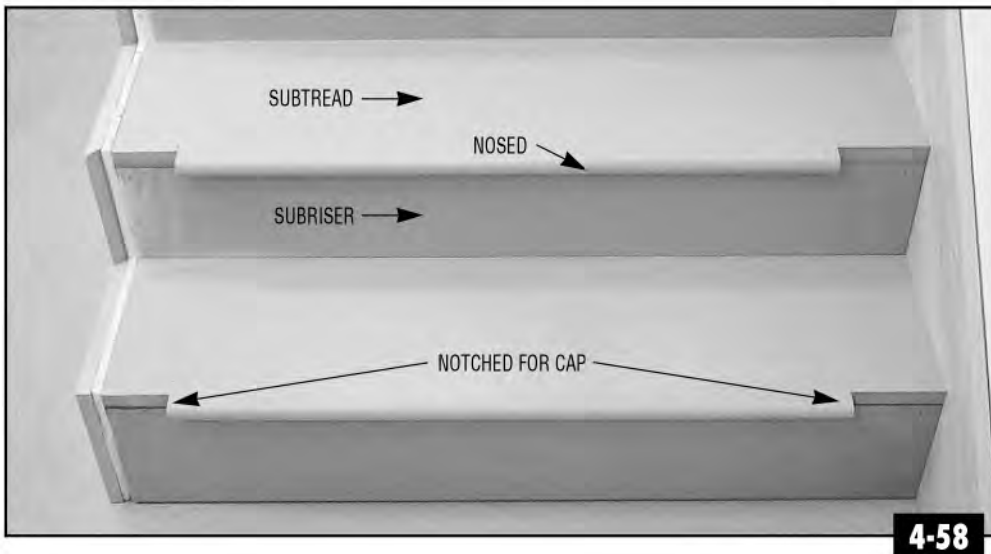

INSTALLING TREAD AND RISER CAPS

Beginning at the bottom of the stair install all riser caps using construction adhesive and nails. As with full risers (See Chapter 4, Page 8), open side riser caps should be mitered into the skirtboard or decorative tread bracket. **PHOTO 4-59.**

Trim the closed side tread cap to fit the skirtboard, cut to the proper depth, and permanently install with construction adhesive and nails. **PHOTO 4-60.**

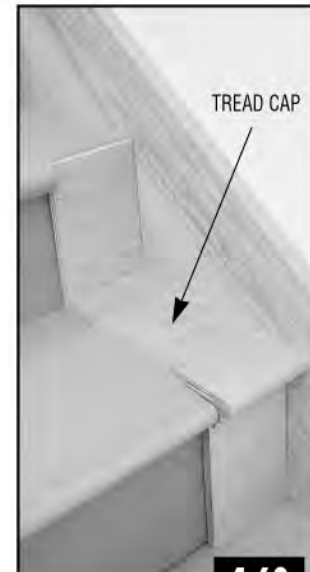

For reversible tread caps, use a table saw to make the necessary cuts and finish cuts with a handsaw or jigsaw **PHOTO 4-61.**

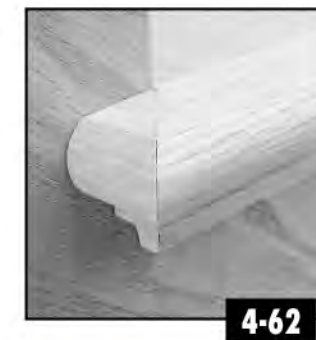

For nonreversible tread caps, trim to length to the mitered return portion of the cap and cut a 45° angle at the riser/skirtboard joint with a sliding miter saw. A small mitered block can then be cut to fit from the waste return nosing, glued, and finish nailed into place. **PHOTO 4-62.**

BULLNOSE STARTING END CAPS

Coffman's bullnose starting end caps are manufactured in both a left and right handed C-8011 as well as in a reversible C-8911. The C-8011 LH or RH starting end caps have a 1" thick tread with a 1/2" slot routed into the bottom of the cap to fit around the riser/skirtboard corner.

PHOTO 4-63. This configuration allows the step to be used directly from the carton with the standard tread caps that are 1/2" thick.



4-63



4-64

The 1" thickness of the reversible C-8911 tread, however, must be accounted for in both rough carriage layout and installation. Either notch the tread with a router to accept the sub-tread (See *Photo 4-63*) or cut a 1/2" shim to fit on top of the first sub-tread. This shim should be trimmed to fit the sub-tread from the edge of the starting end cap to the wall. **PHOTO 4-64.**

NOTE: If the closed side tread cap is shimmed up 1/2" to tie into the 1" thickness of the C-8911, the first rise of the rough carriage must be lowered 1/2" to keep each rise on the stair equal. Refer to *Chapter 3, Page 7, Dropping of Carriage*, for more information on tying finished tread thickness into the design of the stair.

BALUSTRADE LAYOUT

5



CHAPTER 5

Balustrade Layout



The most important consideration when beginning to install the balustrade portion of any stair is the balustrade center line. The center line chosen for your stair will determine both newel and baluster placement and can change from application to application depending on size of baluster, installation techniques, and constraints in stair design.

BALUSTER PLACEMENT

The baluster placement on the rake, or angled portion of the stair will align the outside and front faces of the baluster with the face of the skirtboard (or decorative tread bracket) and riser below. **PHOTO 5-1.** On a 1-1/4" baluster, the center point is the intersection that is 5/8" in from both the skirtboard and riser (1-3/4" balusters will require 7/8", 2-1/2" baluster 1-1/4", etc.). **DRAWING 5-2.**

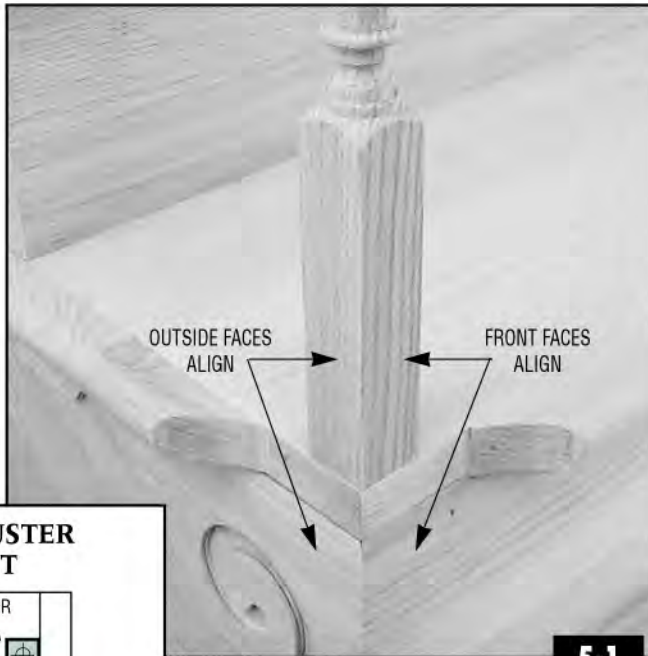

5-1

CORRECT BALUSTER PLACEMENT

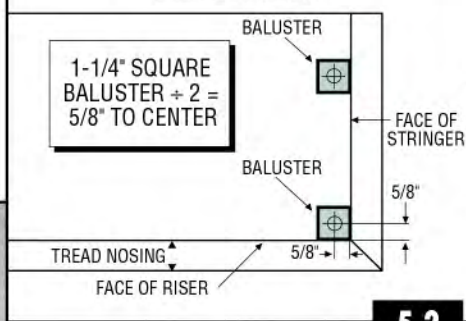

5-2

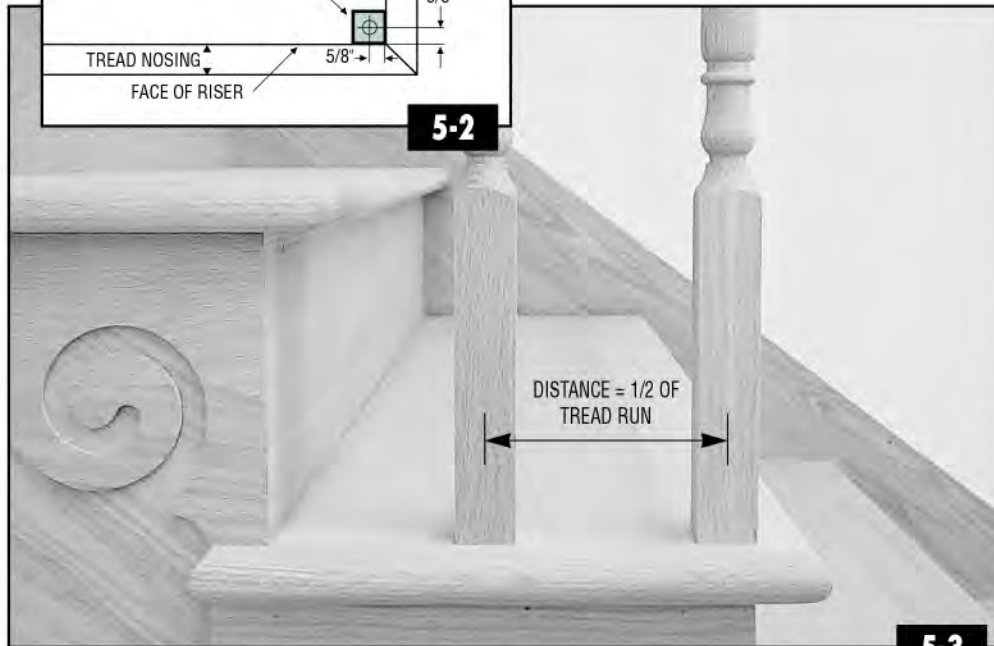

5-3

Once located, this placement will allow you to use the center point of the first baluster to determine the locations of the other balusters on the tread. Simply divide the unit tread run by the number of balusters to be used per tread for center-to-center spacing. For a system using two balusters per tread, divide the run of the tread by 2 (Example: 10" Run ÷ 2 = 5" center-to-center). **PHOTO 5-3.**

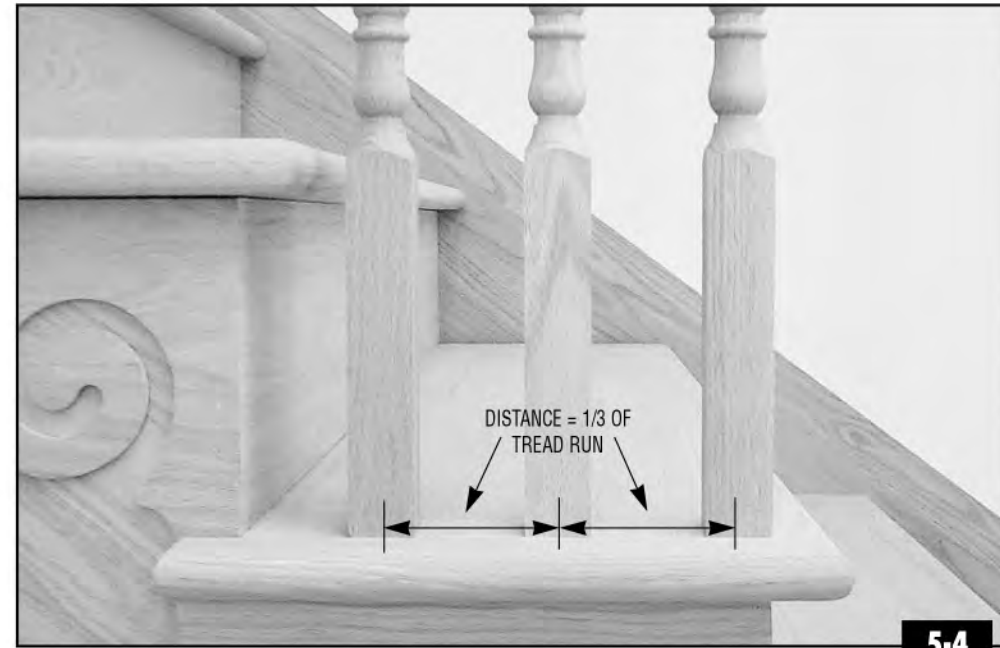

5-4

For 3 balusters per tread, divide tread run by 3 (Example: 10-1/2" Run ÷ 3 = 3-1/2" center-to-center). **PHOTO 5-4.**

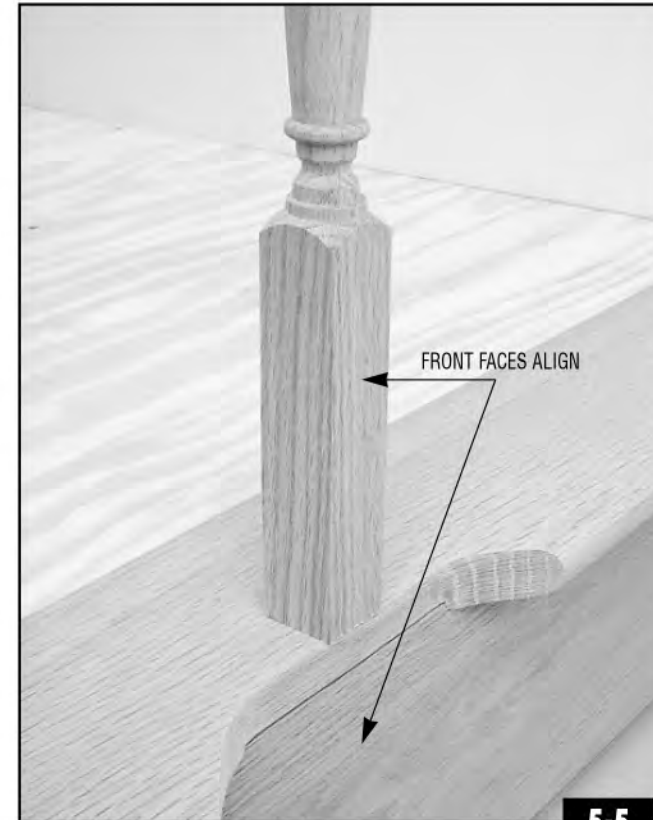

5-5

For balusters on the balcony, or level, portion of a stair, the traditional placement is one that aligns the front face of the baluster to the outside face of the finish material below (i.e. decorative bandboard). **PHOTO 5-5.**

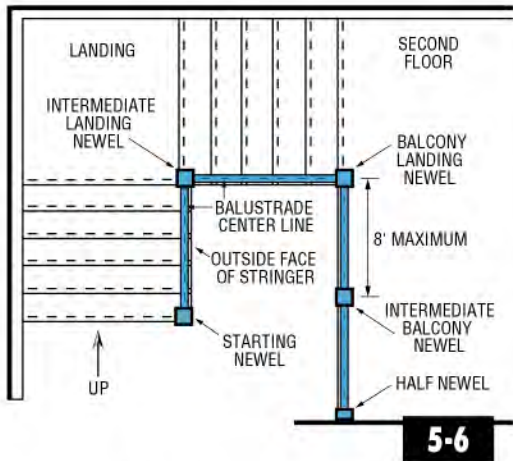

5-6

TRADITIONAL CENTER LINE PLACEMENT

Once baluster center lines are determined, proper newel placements at landings and balconies will become obvious. Each intersection will provide the exact center point for the required location of all newels, including half newels, in the system. (See Page 5-8 for an exception in the Art Deco family.) **DRAWING 5-6** and **PHOTO 5-7**. **NOTE:** For secure installations, it is recommended that newels be placed at the top and bottom of every stair, at all directional changes, and no further apart than 8' on straight sections of balcony level rail.

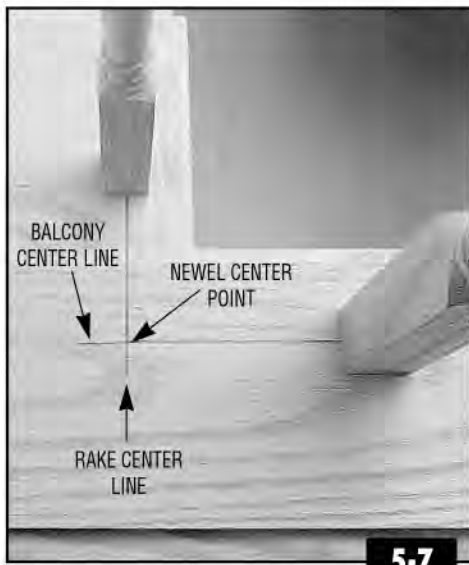

5-7

Traditional starting newel placement, excluding Over-the-Post starting newels placed on bullnose starting steps (See Chapter 6, Page 4), aligns the center of the newel directly above the face of the first riser. **PHOTO 5-8**. When placed for the traditional center line shown in Drawing 5-6, described above, starting newels will have to be notched to fit around the riser/skirtboard assembly.

NOTE: Newels placed on a traditional center line will require notching. See Chapter 6, Page 13, *Notching of Newels*, for detailed instructions on notched newels.

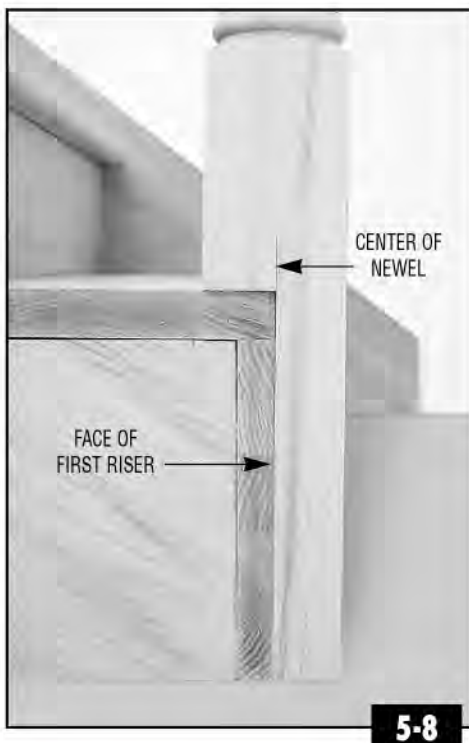

5-8

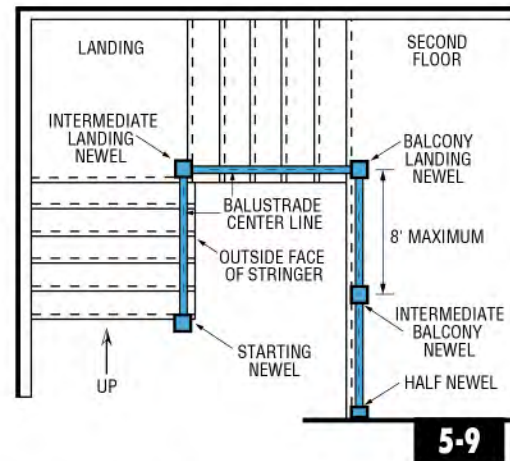

5-9

ALTERNATIVE CENTER LINE PLACEMENT

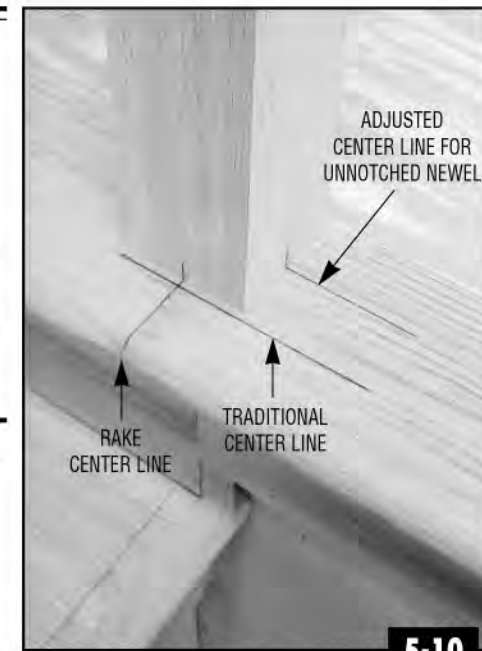

5-10



5-11



5-12



5-13

Alternative center lines will be necessary when unnotched newels are preferred, **DRAWING 5-9** and **PHOTO 5-10**, or when design constraints dictate the placement of the center line. Some examples are having the rail hit the center of a wall on partial open stairs, **PHOTO 5-11**, achieving the necessary handrail clearance at second floor well openings, **PHOTO 5-12**, and moving the balcony center line in to have the rail, and therefore the rosette or half newel, terminate solidly into a wall. **PHOTO 5-13**.

Once the balustrade center lines are determined and layout of the balusters on each tread is complete, you can address exact baluster location on the balcony portions of the stair. Actual placement of the balusters must be determined using the outline listed below to allow for even center-to-center placement. To ensure equal spacing between the balusters, individual placement of the balusters on a balcony should be determined after the newels are installed. See Chapter 6, Page 10 for more information on balcony newel installation and Chapter 2, Page 28 for more information on baluster spacing and recommended center-to-center spacing. As always, local building code requirements should be reviewed before proceeding.

BALUSTER SPACING FOR BALCONIES AND KNEE WALLS

Step 1. MEASURE

Measure the opening between the bottom square block of the newel and either the opposing newel or wall. Example: 71".

PHOTO 5-14.



Step 2. ADD BALUSTER SQUARE DIMENSION

Because you are trying to achieve exact center-to-center measurements over the entire run, you must add the thickness of a baluster to the measurement taken in Step 1. The edge of the newel (or wall) represents the edge, and not the center point, of what would be the next baluster in the run. You must therefore add 1/2 of the dimension of the baluster square to each end of the run (effectively totaling one baluster square thickness) before dividing the run into equal parts. $71 + 1-1/4" = 72-1/4"$. **PHOTO 5-15.**

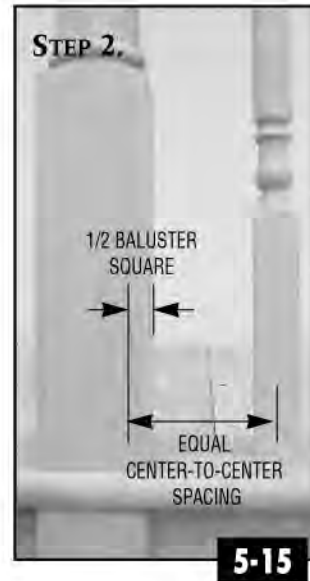

Step 3. DIVIDE BY RECOMMENDED CENTER-TO-CENTER SPACING

Depending on the code requirements, divide the total adjusted run by the required spacing. In our example of 1-1/4" balusters used with a 4" sphere rule in effect (See Chart 2-84), a 4-1/2" center-to-center spacing would most commonly be used. $72-1/4" \div 4.5" = 16.05$. Round to 17 (always round up) and divide back into the overall run. $72-1/4" \div 17 = 4-1/4"$. This balcony rail segment will contain 17 equal spaces and 16 balusters. **PHOTO 5-16.**



Step 4. MARK FIRST BALUSTER ON EITHER END OF SECTION

Take the center-to-center spacing measurement from Step 3 and subtract 1/2 of the baluster square. $4-1/4" - 1/2(1-1/4") = 4-1/4" - 5/8" = 3-5/8"$. This measurement will be used to mark the placement of the end balusters (next to a newel or wall) on either side of the balcony segment. **PHOTO 5-17.**



CAUTION: On some product combinations used with the 4" sphere rule in effect, this form of layout will cause a non-code compliant situation in the turned areas of newels and balusters. Check your spacing before continuing.

PHOTO 5-18. If the first baluster spacing needs to be adjusted, adjust on both ends of the segment, remeasure between the two new points, and redivide.



Step 5. DIVIDE AND MARK REMAINING INTERIOR BALUSTERS

Using dividers set to the center-to-center spacing (4-1/4"), divide and mark the remaining balcony segment between the end balusters marked above. If the mark does not fall exactly on the end baluster mark from Step 4, adjust dividers accordingly and redivide. **PHOTO 5-19.** A standard tape measure can be used in the absence of dividers.



Step 6. REPEAT AS NECESSARY

Repeat for any additional baluster segments. **PHOTO 5-20.**

Equal baluster spacing for the rake portion of a knee wall system can also be accomplished using these formulas. Begin with a measurement between the installed newels and proceed as outlined above.

ART DECO BALUSTRADE PLANNING

Because of the contemporary styling of the Coffman Art Deco family, Over-the-Post newel placement at all directional changes in the stair will have to be adjusted. All Art Deco fittings are produced without caps, making standard newel placement on the intersections of the balustrade center lines unusable in this family. **PHOTO 5-21.** Art Deco newel placement must be adjusted so that the newel's 1-1/8" diameter top will intercept the center of the straight section of the gooseneck or level quarterturn (*between the clamp nails used to manufacture the product*). Adjust the center point of the newel into the turn as shown in **PHOTO 5-22.** The finished product will then flow smoothly through the transition. **PHOTO 5-23.**

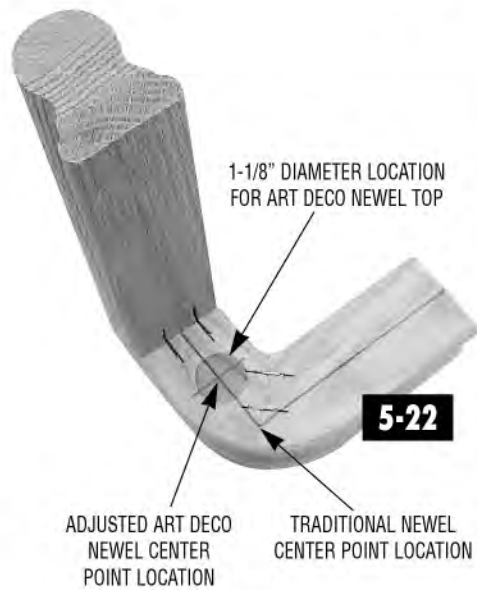
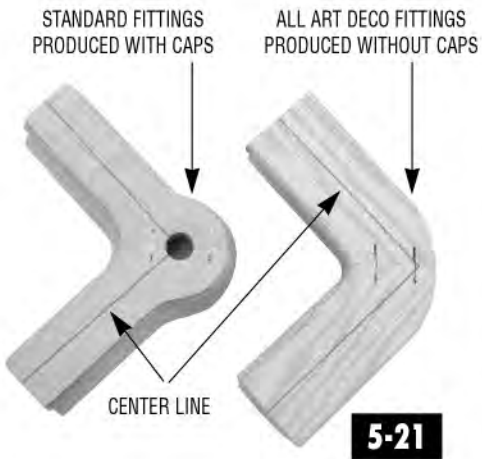

WM Coffman®

NEWEL INSTALLATION



6

CHAPTER 6

Newel Installation



Proper newel installation is critical to ensuring a correctly built, code compliant staircase. Height of the installed newels determines both the rake and balcony rail heights, while secure installation and proper placement will be the main determining factors in overall balustrade strength. Newels should be placed at the top and bottom of every stair, at all directional changes, and no further apart than 8' on straight sections of balcony level rail.

All newels should be installed with the use of construction adhesive or carpenter's glue. Refer to Chapter 2 for more information concerning newels and their uses.

6-1



6-2

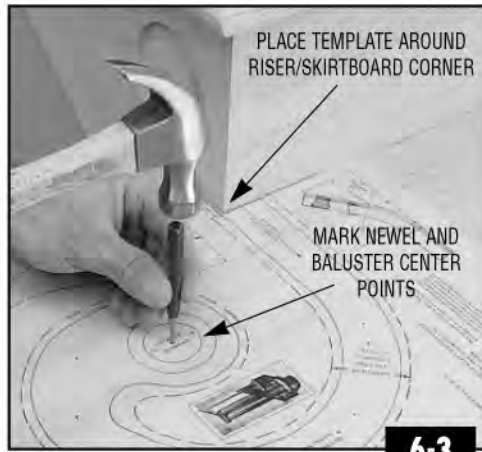

6-3

OTP STARTING NEWEL LAYOUT

For Over-the-Post applications using turnouts or volutes, a C-8010 single end or C-8015 double end bullnose starting step will be required.

A template provided with all starting fittings will mark proper placement of the newel on the bullnose starting step. For standard center line placement (See Photo 5-1) trim template according to baluster size used and place on top of prefitted starting step with the notch around the riser/skirtboard corner. **PHOTO 6-2**. Mark newel center point with a nail punch or awl. Baluster center points can also be marked at this time. **PHOTO 6-3**.

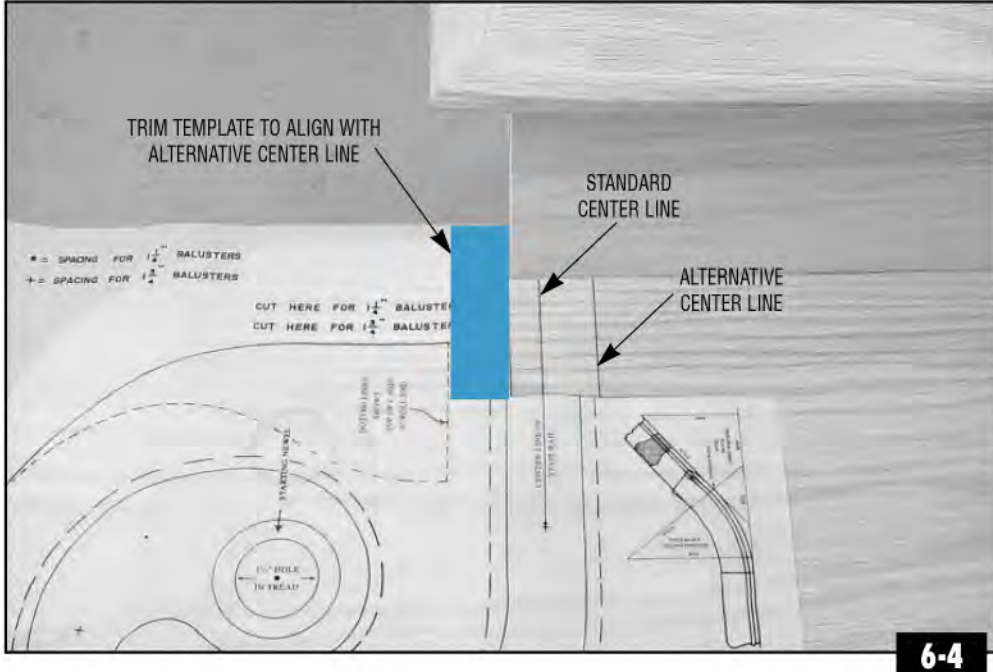

6-4

NOTE: If center line has been moved for any reason (See Chapter 5, Page 5) the template will have to be adjusted by trimming the edge adjacent to the skirtboard until the center line on the template lines up with the adjusted center line on your stair. **PHOTO 6-4**.

OTP STARTING NEWEL HEIGHTS (For a 34" Rake Rail Height)

STARTING FITTING	NET MEASUREMENT
STARTING EASING	36-1/2"
TURNOUT	40-1/2"
VOLUTE	39"
ASCENDING VOLUTE	36"
VERTICAL VOLUTE	33-7/8"

6-5

STARTING NEWEL INSTALLATION

The main determining factor in the rake rail height achieved is the height (*in correlation to the placement*) of the installed starting newel.

Before installing any starting newel, be sure that the height of your newel will work for the rake rail height that you wish to achieve. **CHART 6-5** summarizes newel lengths for a 34" rake rail height (See Chart 2-58). Refer to Chapter 2, Pages 14-19 for more complete information on correct newel placement and requirements for rail height adjustments.

NOTE: Newels are laminated and therefore have two solid faces and two faces with glue lines. We recommend you turn the newel in order that the solid faces are directed in the most visible directions.

DOWELED OVER-THE-POST STARTING NEWELS

For doweled Over-the-Post newels installed in starting steps, start by prefitting the starting riser and tread to the stair. With the riser and tread in place, drill a 1-1/2" diameter hole through the starting tread and the upper riser core block at the marked location.

PHOTO 6-6.



6-6

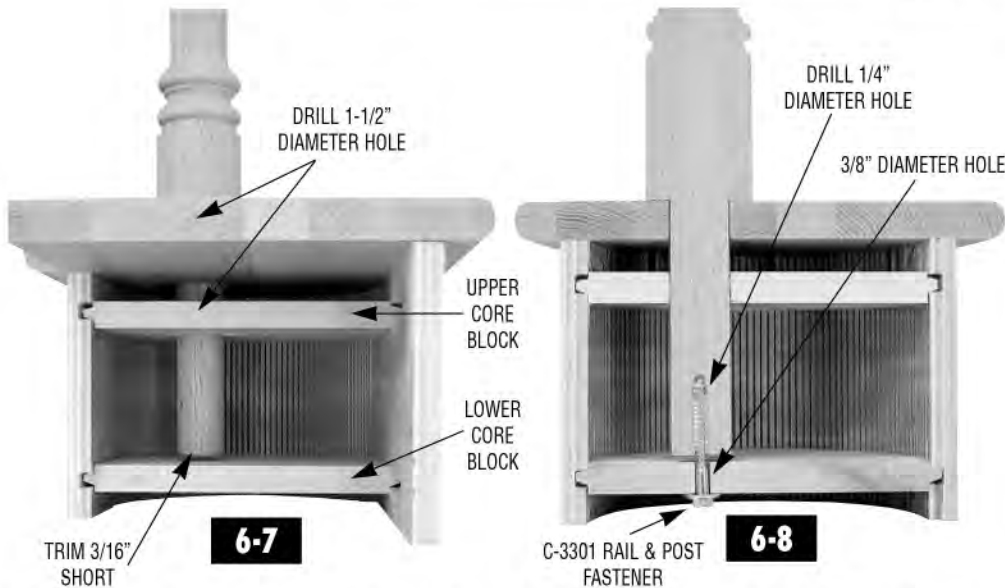

6-7

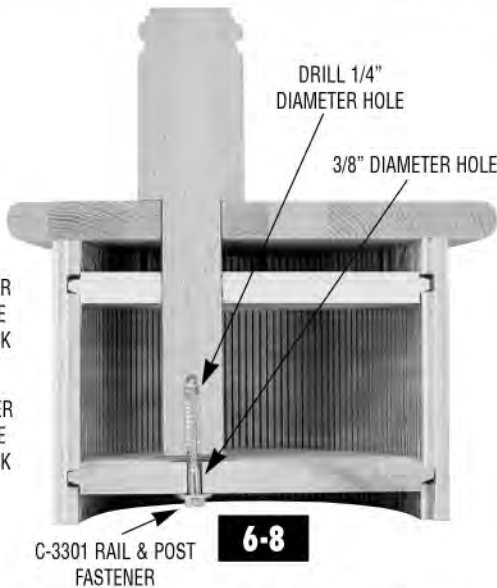

6-8

Mark and trim the dowel on your starting newel to leave approximately 3/16" space between the dowel and lower core block. **PHOTO 6-7.** With newel placed in the step, drill a 1/4" diameter hole through the bottom of the lower core block into the center of the dowel approximately 3". Remove newel and re-bore the hole in the lower block to 3/8". Liberally apply construction adhesive and permanently attach starting step with a 5/16" x 3" Coffman C-3301 Rail & Post Fastener (See Chapter 12, Page 4 for full instructions).

PHOTO 6-8. For alternative installations, See Photo 6-27.



6-9

ADJUSTABLE NEWELS

Coffman's line of adjustable newels provides a starting newel with the flexibility to be used with both turnouts and volutes over a wide range of rake rail height requirements. These versatile newels are manufactured with a 1-1/2" diameter hole bored 10" deep into the bottom of the newel and have a 19" dowel shipped unattached.

PHOTO 6-9.



6-10



6-11

Adjustable newels are available in all of Coffman's Over-the-Post families and are easily identifiable in Coffman catalogs by the dotted line signifying the bored hole in the base. **DRAWING 6-10.** These newels allow a 4" range of cut for exact starting newel height adjustment in the field. Determine the exact height of the newel needed for your application (See Table 2-58), trim the newel, and apply dowel with construction adhesive and finish nails. **PHOTO 6-11.** Standard installation techniques outlined in Chapter 6, Page 4 are then applicable.



6-12

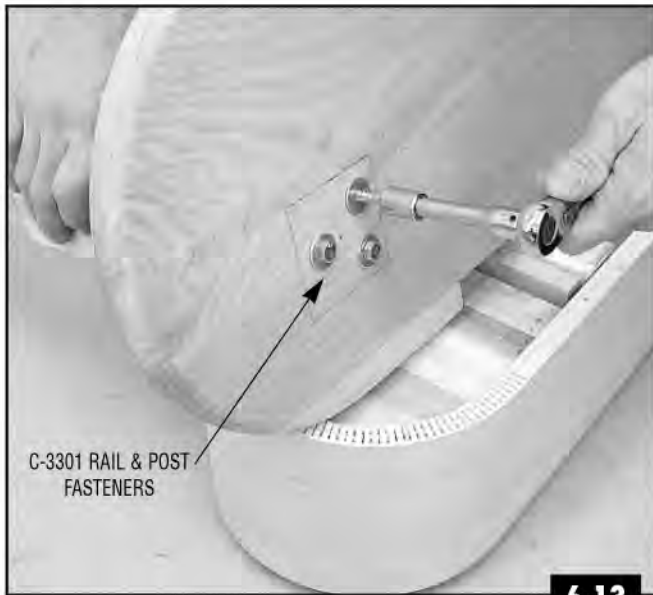

6-13

UNDOWELED NEWELS ON STARTING STEPS

Although Coffman recommends the use of starting newels with dowel bottoms, nondoweled, square bottom newels may be used if desired.

Begin installation by prefitting and permanently installing the starting riser to the stair using standard installation procedures. The nondoweled, square bottomed newel will then have to be installed onto the starting tread. Locate the newel center point (See Photo 6-3), lay out the newel location, and drill three equally spaced 3/8" diameter holes through the tread in the newel location. **PHOTO 6-12.** Place the newel on top of the step in the required location and mark the location of one of the 3/8" holes on the bottom of the newel. Drill a 1/4" diameter pilot hole 3" deep into the newel at the marked location. Using carpenter's glue on the bottom of the newel square, install a C-3301 Rail & Post Fastener into the predrilled hole. Pilot holes can then be drilled into the other 3/8" diameter holes and C-3301 Fasteners installed. **PHOTO 6-13.**

NOTE: One disadvantage of a square bottom newel in a volute application is the closeness of the nearest baluster to the newel. This baluster will be less than 1/4" from the starting newel unless placement of the baluster is moved from the traditional location provided on the template.

PHOTO 6-14.

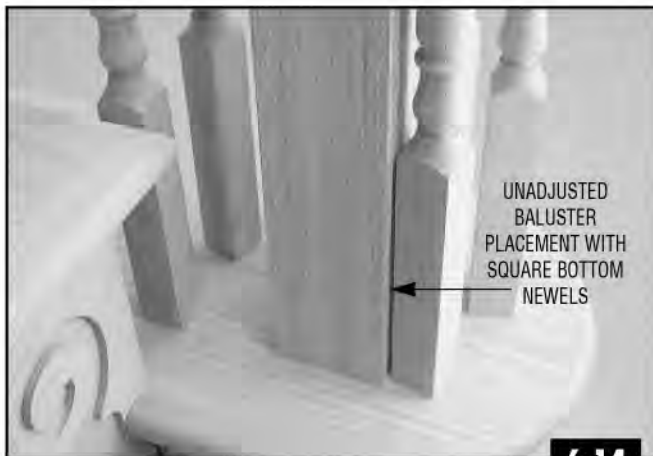

6-14

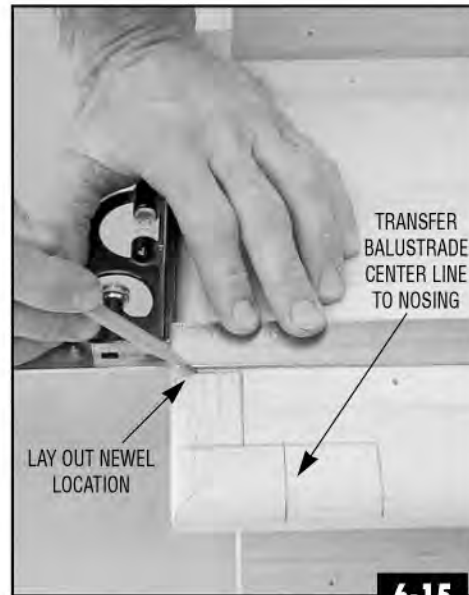

6-15



6-16

NOTCHED STARTING NEWELS (OTP OR PTP)

For Post-to-Post applications or Over-the-Post applications using starting easings, the traditionally correct placement of the starting newel will be with the center of the newel aligned directly above the face of the first riser (See Photo 5-8). This placement of the center line will require both a quarter-notched newel (See Page 6-13, *Notching of Newels*) as well as a notched cut into the tread overhang above the riser/skirtboard corner. Begin by transferring the center line of the stair to the front nosing of the first tread. Using a combination square, lay out the location of the newel. These lines will make the required cut lines for the notch on the tread overhang obvious. **PHOTO 6-15.** Cut with jigsaw and file to fit. **PHOTO 6-16.**

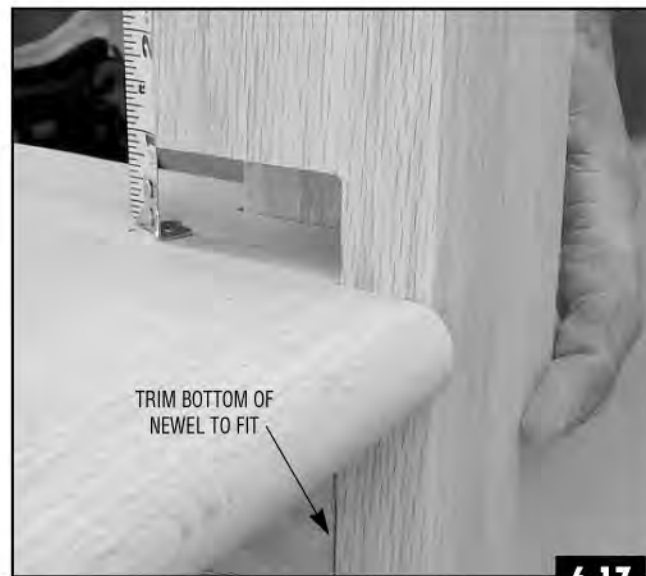

6-17

With the newel notch cut for the required rake rail height, trim the notched portion at the bottom of newel to the necessary finished length.

PHOTO 6-17.

Prepare the quarter notched newel for installation by drilling two 1" diameter by 3/4" deep holes for C-3301 Rail & Post Fasteners in the front face of the newel (See Chapter 12, Page 4). Two staggered 1/2" diameter by 1/2" deep holes for wood screws in the adjacent side face are also recommended.

NOTE: Occasionally the balustrade center line will require a notch in the newel that leaves the side thickness insufficient for the use of a wood screw and plug. In this situation, use C-3301 Rail & Post Fasteners in the front face of the newel and toe-nail the outside face.



PREPARE NOTCHED NEWEL
(SEE CHAPTER 12, PAGE 4,
C-3301 RAIL & POST FASTENER)

6-18



PLUMB NEWEL

DRILL PILOT HOLES

6-19

For secure mounting, the two holes in the front face of the newel must be aligned with the center of the outside rough carriage. With a 3/8" diameter bit, drill through the center of the 1" diameter holes in the front face of the newel. **PHOTO 6-18.** With the newel held in place and plumb, drill a 1/4" diameter pilot hole approximately 3" deep through the two lag bolt holes. If wood screws are used in the adjacent side face, access and pilot holes corresponding to the size of wood screw used should also be drilled at this time.

PHOTO 6-19.

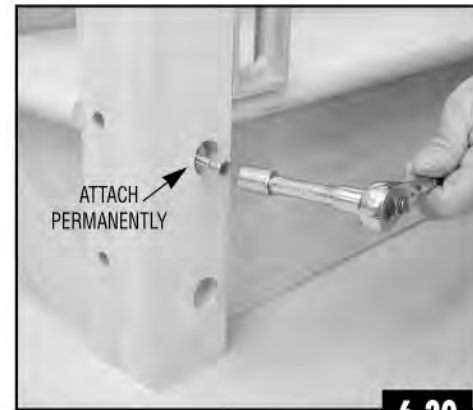

ATTACH
PERMANENTLY

6-20

Attach with construction adhesive, Coffman C-3301 Rail & Post Fasteners in the front face, and wood screws in the side face.

PHOTO 6-20.

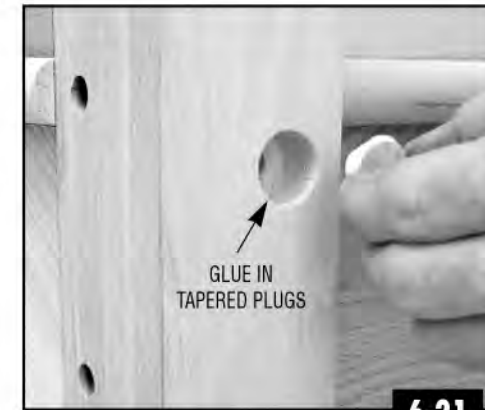

GLUE IN
TAPERED PLUGS

6-21

To complete installation, glue tapered plugs into holes, putty and finish sand.

PHOTO 6-21.

NOTE: Matching the grain direction of the plug to that of the newel will provide for a more finished final appearance.

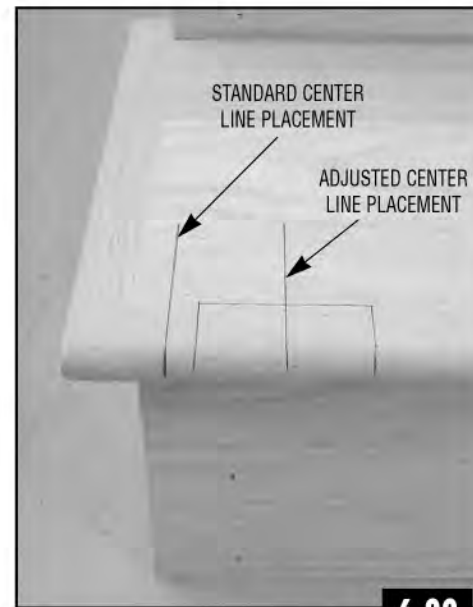

STANDARD CENTER
LINE PLACEMENT

ADJUSTED CENTER
LINE PLACEMENT

6-22

ADJUSTED CENTER LINE

When the center line has been adjusted into the stair, a half-notched newel may be required (See Chapter 6, Page 13, Notching of Newels). Transfer the center line of the stair to the nosing of the tread and lay out newel placement with a combination square. Notch the tread with a jigsaw and file for custom fit. **PHOTO 6-22.**

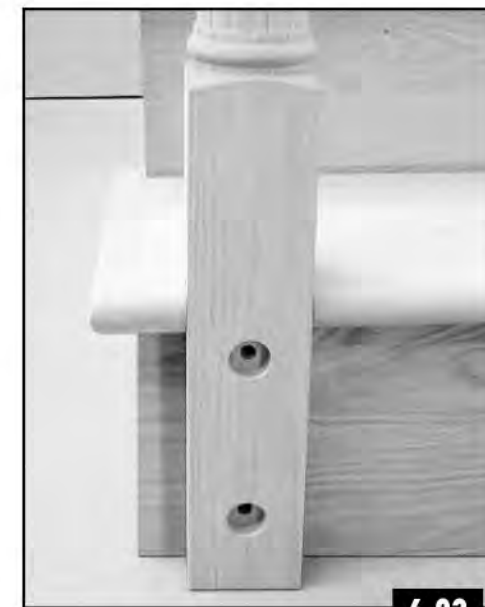

6-23

Use standard techniques outlined earlier with two C-3301 Rail & Post Fasteners into solid blocking. **PHOTO 6-23.**

INTERMEDIATE LANDING NEWELS

The installation of intermediate landing newels in both Over-the-Post and Post-to-Post systems is very similar to the system detailed in *Chapter 6, Pages 7-9* with the exception of the complexity of the notches. A notched newel, installed with construction adhesive, C-3301 Rail & Post Fasteners, and 4" wood screws where necessary, will provide the strength needed at this critical juncture in the stair system. Remember that placement is dictated by the intersecting center lines (*See Photo 5-7*) and that the newel must be notched to fit into this position. **PHOTO 6-24.** *NOTE:* See Art Deco exception, *Chapter 5, Page 8.*

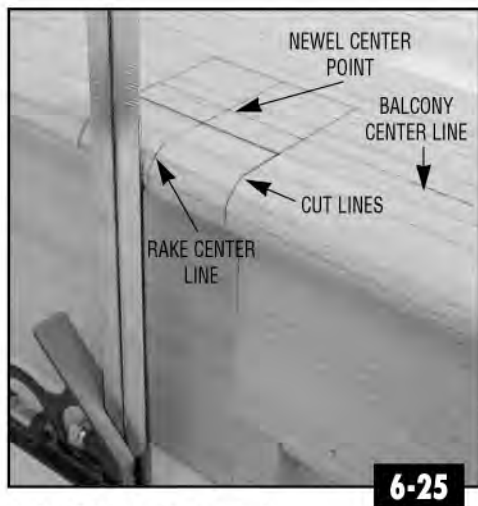

BALCONY NEWELS

Balcony newel placement will be determined by the positioning of the balcony center line and should be equally spaced on the balcony (*not to exceed 8 ft.*). Standard placement (*See Photo 5-5*) will require a half-notched newel installed with C-3301 Rail & Post Fasteners. (*Note Art Deco exception in Chapter 5, Page 8*) To locate the required notch in the tread nosing, use a combination square to transfer the center line from the rake portion of the stair to the nosing of the landing tread. Using this mark and the location of the balcony center line, lay out newel location on the landing tread. **PHOTO 6-25.** Make required notch with jigsaw and file for finished fit. **PHOTO 6-26.** Trim the newel to fit and install into solid blocking (*See Chapter 3, Page 14*) using C-3301 Rail & Post Fasteners.

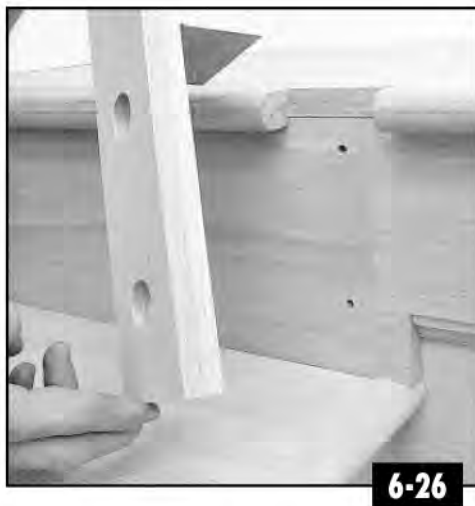

A common installation technique is to move the center line back into the second floor to allow the newel to be cut flat on the bottom (*See Drawing 5-9*). This type of installation lends itself to numerous installation techniques, the two most common of which are listed below.



C-3008. The Coffman C-3008 Sure-Tite Newel Fastening System consists of a 10-3/4" attaching bolt, nut, washer, and tapered hole plug. To install, drill a 3/8" diameter hole 5" deep into the solid flooring or support blocking and insert bolt with Vise Grips. **PHOTO 6-27.**

NOTE: The C-3008 can also be used to secure starting newels in field-blocked starting steps (*See Chapter 6, Page 4*).



Next drill a 1-1/2" diameter access hole into the face of the newel 5" from the bottom and 2" deep.

NOTE: Access holes located on a side face of the newel will become less obvious once the balusters are installed.

A 5/8" diameter guide hole drilled in the center of the bottom of the newel into the access hole completes the preparation of the newel.

The newel can then be slid onto the bolt, tightened with the nut and washer, and plugged with the supplied 1-1/2" tapered plug. See *Chapter 12, Page 2*, C-3008 Sure-Tite Newel Fastening System, for more detailed instructions. **PHOTO 6-28.**

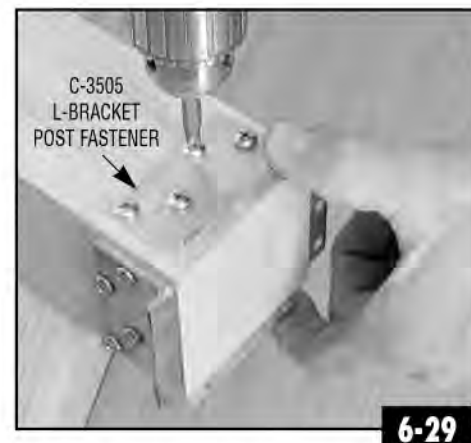

C-3505. The Coffman C-3505 L-Bracket Post Fastener consists of four metal brackets, wood screws, and mitered wood trim pieces. Align the brackets flush with the bottom of the newel and screw into the face of the newel. **PHOTO 6-29.**



Place newel into correct position and install screws at an angle into the mounting surface. Finish by gluing and nailing the premitered trim pieces around the brackets. **PHOTO 6-30.** See *Chapter 12, Page 5*, C-3505 L-Bracket Post Fastener.

HALF NEWEL INSTALLATION

All half newels should be installed into solid blocking.

For Post-to-Post half newels, use Coffman C-3301 Rail & Post Fasteners in both the upper and lower square blocks.

PHOTO 6-31.



For turned Over-the-Post half newels, the top C-3301 Fastener should be replaced with either a single 4" wood screw and 1/2" tapered plug sanded to the contour of the newel or two finish nails driven in at opposing angles.

PHOTO 6-32.

NOTE: Refer to Chapter 7, Page 16 for half newel installation on a partial-open stair.



NOTCHING OF NEWELS

HALF NOTCHED NEWELS

Begin by using a combination square to clearly mark the part of the newel that must be removed.

PHOTO 6-33.



Adjust the fence of the tablesaw to the proper width and raise the blade as high as possible.

PHOTO 6-34.

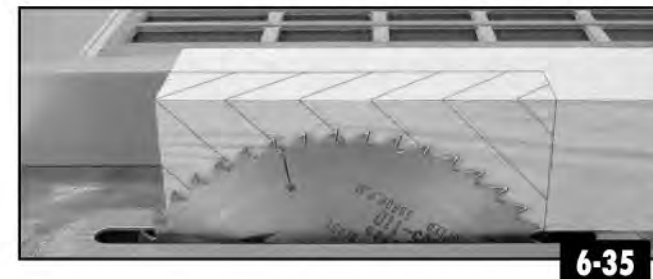

Align the saw blade to the mark on the newel representing the end of the required rip cut and place a mark on the saw so that the cut will not exceed this distance. A piece of masking tape placed onto the saw at the bottom of the newel works well as a reference point. Cut one side, adjust the fence, and make adjoining cut on the other side.

PHOTO 6-35 and PHOTO 6-36.



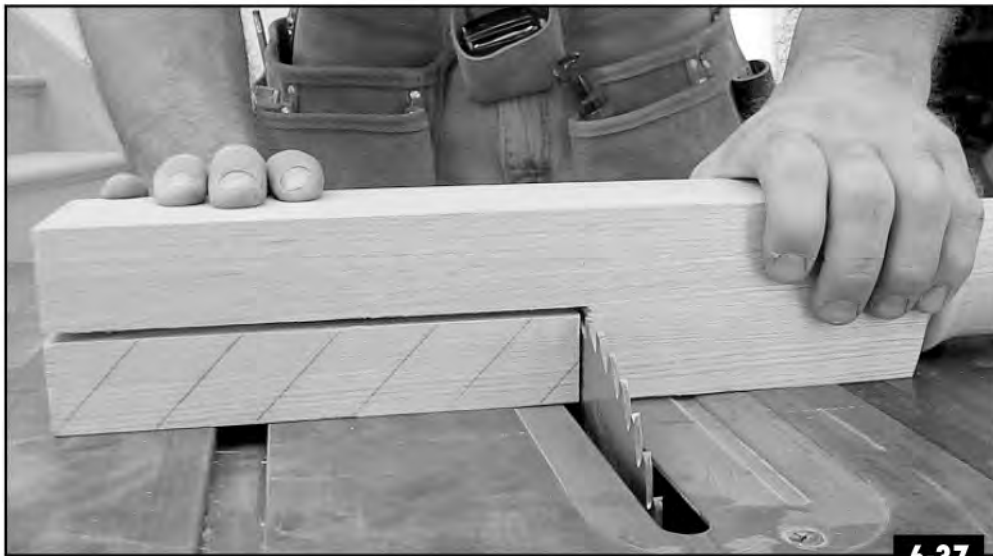

6-37

Adjust saw blade height to the depth of the notch and use the push-through to complete the notch. **PHOTO 6-37.**



6-38

Use a hammer and chisel to carefully remove the block and any excess wood at the top of the notch. Remember that the middle portion of the notch will be hidden when installed, allowing you to quickly chisel the notch without regard to finish appearance. **PHOTO 6-38.**

Finished Half Notch. **PHOTO 6-39.**



6-39



6-40

QUARTER NOTCHED NEWELS

Begin by clearly marking the part of the newel to remove. **PHOTO 6-40.**

Adjust the saw blade to the depth of first notch and mark the saw for distance of the cut as detailed in *Photo 6-35*. Adjust the fence for the width of the cut and make your cut. Repeat for second notch on the adjacent side. **PHOTO 6-41.**

Use hand back saw or sliding power miter saw to make horizontal crosscut between the two vertical cuts. **PHOTO 6-42.**

Use a hammer and chisel to remove the block and any excess wood inside the notch.

Finished Quarter Notch. **PHOTO 6-43.**



6-41



6-42



6-43

INTERMEDIATE LANDING NOTCHED NEWELS

Although more complex than the half notch or quarter notch, an intermediate landing notch can be made using the same principles outlined in the prior two sections. Clearly mark the sections to be removed, rip cut the vertical lines where necessary, crosscut, and chisel inside the edges. A practice run on any scrap material is recommended for those who may be inexperienced with this complex cut.

NOTE: It is sometimes easier to look at the notch in an intermediate landing newel as two individual notches tied together rather than one large, complicated cut. The upper portion of the intermediate notch is nothing more than a quarter notch (See *Photo 6-43*) that will drape down to the intermediate landing. The lower portion of the notch is very similar to the half notch and will continue to drape down to the top of the last tread before the landing (See *Photo 6-39*).

Finished Intermediate Landing Notch.
PHOTO 6-44.



6-44

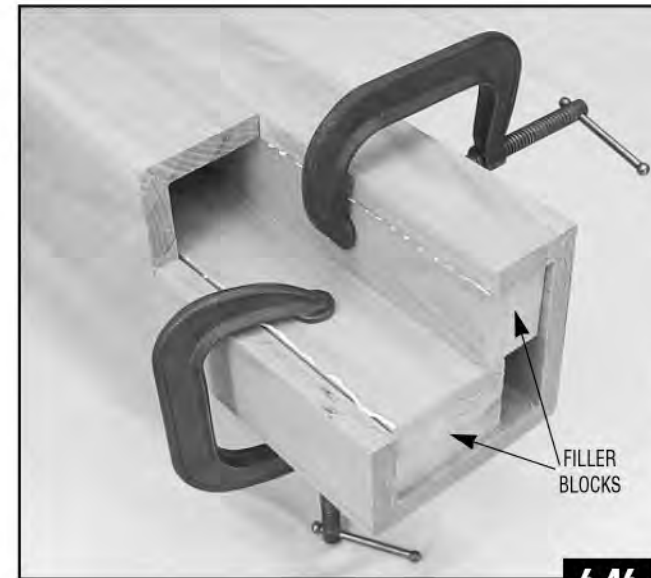

6-46

Once the cuts have been completed, filler blocks should be glued, nailed, and temporarily clamped into the lower 8" of the hollow interior core of the box newel. **PHOTO 6-46.**

BOX NEWEL INSTALLATION

Like all newels, Coffman's box newels are installed on the balustrade center line. Support blocking attached to the rough carriage is strongly recommended because of the size of the newel.

When mounted on the floor or sitting on a Coffman C-8030 starting step, a quarter notch cut will normally be required to allow the newel to wrap around the riser/skirtboard corner. **PHOTO 6-45.** Like the quarter notched cut on regular newels, the portion of the newel to be removed should be clearly marked with a combination square before any cutting begins. Remember that the center of the newel must be aligned with the face of the riser below it.

6-45



6-47

After sufficient drying time, the newel can then be installed using construction adhesive, commercially available 6" lag bolts, and tapered plugs. **PHOTO 6-47.**

To mount box newels flush to the floor, create a filler block that is the same size as the hollow core in the bottom of the newel. Securely fasten the filler block at the necessary location. Using construction adhesive, slide the box newel over the block and secure from all sides with 4" wood screws or finish nails.

KNEE WALL NEWELS

Knee wall newels can be installed in one of the following two manners.



If the finished knee wall already exists, a half notched newel, cut to the angle of the stair, can be installed with C-3301 Rail & Post Fasteners. **PHOTO 6-48.**



If the finished knee wall is not complete, mount the full newel to the solid framing of the wall. The skirtboards and capboard of the knee wall can then be fitted and installed around the newel. **PHOTO 6-49.**

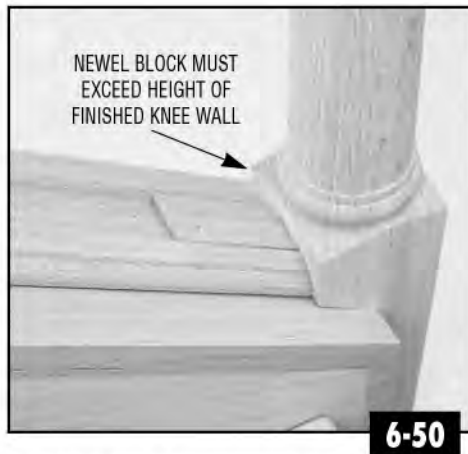

The height of the knee wall, in correlation to the rake rail height, will sometimes create a situation where the bottom square block of the newel is too short for the application. **PHOTO 6-50.**

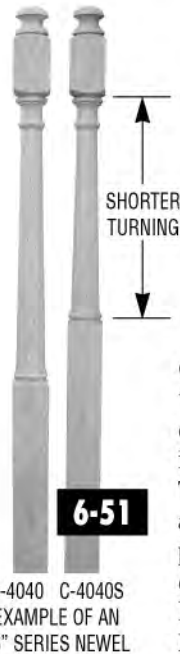

C-4040 C-4040S
EXAMPLE OF AN
"S" SERIES NEWEL

Coffman offers an "S" Series Newel in certain profiles to work in these situations. These "S" newels have a shortened turned portion in the newel, effectively leaving a longer bottom square. **PHOTO 6-51.**

WM Coffman®

RAIL AND FITTINGS



7



CHAPTER 7

Rail and Fittings



7-1

After the newel posts are installed, the next step in the installation process will be to fit and temporarily install the handrail throughout the stair.



7-2



7-3

POST-TO-POST

Begin by laying the straight piece of rail on the nosing of the treads alongside the edge of the two newels. Using the square face of the newels as a guide, scribe a line on the rail at both the top and bottom of the stair. **PHOTO 7-2**. If the newels are plumb, these cut lines will work exactly when the rail is raised to the proper rake rail height.

After the rail is cut, a clamp applied at the proper location on the upper block of the starting newel will allow you to rest the rail between the newel posts as you determine any necessary angle and length adjustments. **PHOTO 7-3**. Remember to check both the rake rail height near the top of the run as well as the plumb of the newels, as a piece of rail left slightly long can spread the newels or increase the desired rake rail height.

POST-TO-POST RAIL ATTACHMENTS

Once the piece of rail is custom fit, it should be temporarily installed to the newel posts. Handrail should be attached using one of the following techniques.

COFFMAN C-3301 RAIL & POST FASTENER

Coffman's Rail & Post Fastener is installed from the opposite side of the newel. **PHOTO 7-4**. Refer to Chapter 12, Page 4 for full instructions.



7-4



7-5

WM COFFMAN RAIL BOLT

A rail bolt, normally used for rail-to-rail or rail-to-fitting connections, can also be used to securely attach the lower side of Post-to-Post rails to the newels (Refer to Chapter 12, Page 4 for full instructions). **PHOTO 7-5**.

NOTE: It should be cautioned that rail bolts cannot be utilized on the upper end of rake rail due to the inability to gain access to tighten the bolt. Use the C-3301 Rail & Post Fastener.



7-6

POST-TO-POST BALCONY RAIL

Once all rake rails have been temporarily attached, balcony rail requirements can then be addressed.

A measurement should be taken between the upper square blocks and transferred to a straight piece of rail. Cut the rail slightly long, place between newels, note necessary angle adjustments and trim to fit. **PHOTO 7-6**.

Installation can be accomplished with C-3301 Rail & Post Fasteners or a combination of fasteners and rail bolts.

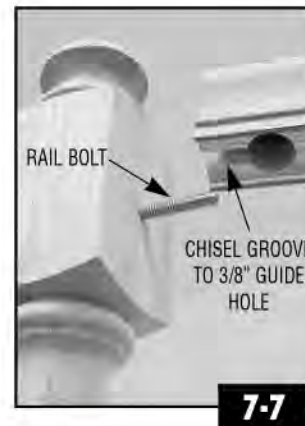

7-7

NOTE: A rail bolt used at both ends of a section of balcony rail can only be used with plowed handrails. When plowed handrails are being utilized with square top balusters, the fillet installed between the balusters will hide any milling that is required for the use of rail bolts. Chisel a groove to the 3/8" guide hole to allow the rail to be dropped onto the rail bolt, effectively allowing rail bolts to be used throughout the balcony sections. **PHOTO 7-7**.

When the rail terminates into a half-newel, apply the same techniques previously outlined to temporarily attach the handrail. For rail ending in a rosette, attach the rosette as outlined in Chapter 7, Page 17 and temporarily shim or tack into place.

OVER-THE-POST

MARKING STARTING FITTINGS AND UPPER SIDE OF INTERMEDIATE LANDING FITTINGS

All starting fittings (volumes, turnouts, and starting easings) and intermediate landing goosenecks are manufactured with the use of a curved piece of rail called an easing.

PHOTO 7-8.

Designed to accommodate every code acceptable stair angle, a correctly cut easing, when joined with a 90° cut on the straight piece of rail, will carry the handrail up the stair at the correct pitch regardless of the angle of the stair. **PHOTO 7-9.**

The most commonly used method, if not the most efficient (See *Photo 7-18, Coffman Miter Jig*), of achieving the correct cut on the easing is with the use of a pitch block. A pitch block is a triangular representation of the rise, run, and rake angle (*pitch*) of your stair. **PHOTO 7-10.** The pitch block can be generated from the triangular scrap produced when cutting the rough horse or skirtboard but is more accurate when using your individual rise and run dimensions on a scrap piece of plywood.

When using the pitch block to mark the starting fitting, begin by placing the bottom of the fitting on a flat surface. With the run side of the pitch block down, mark the tangent point where the bottom of the easing touches the pitch side. **PHOTO 7-11.**

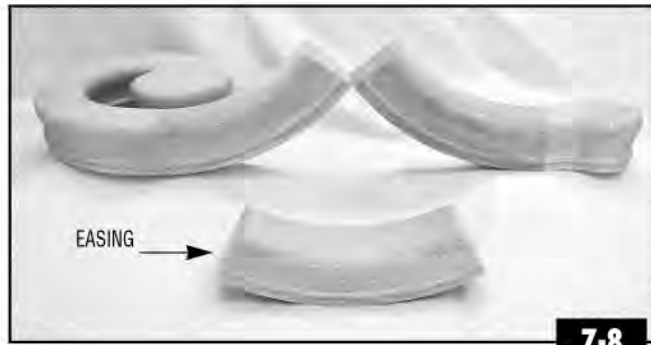

7-8



7-9

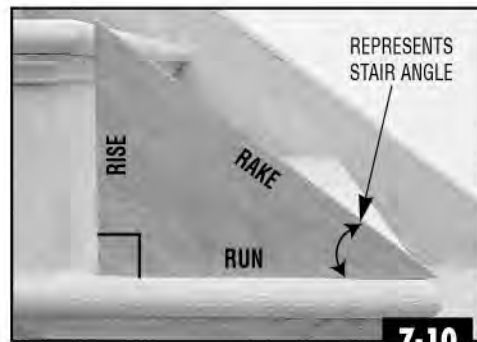

7-10

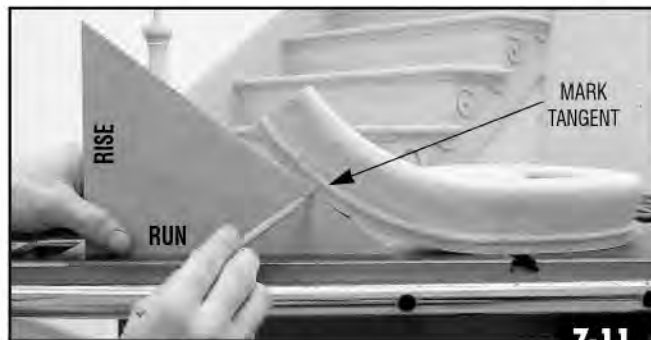

7-11

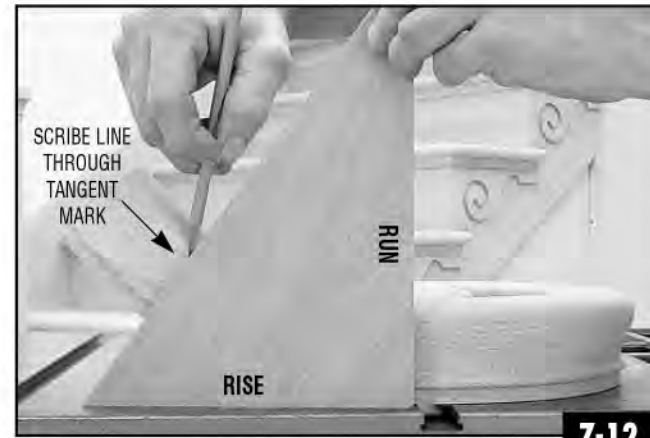

7-12

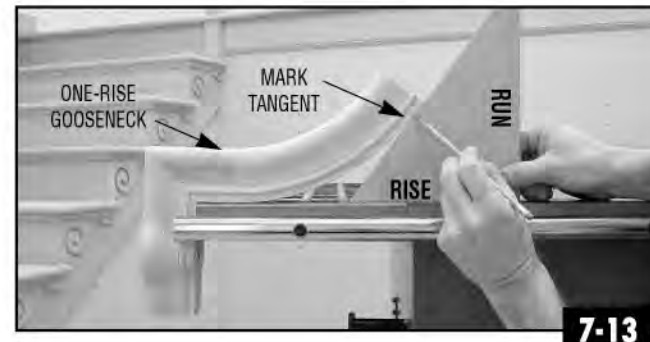

7-13

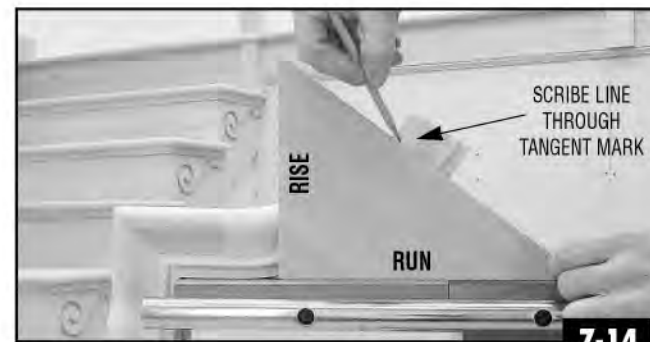

7-14

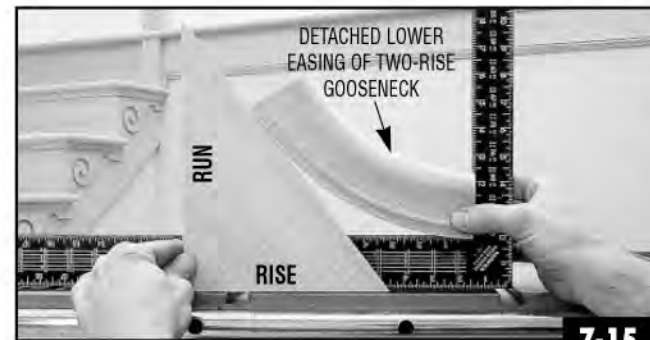

7-15

Turn the pitch block 90° to rise side down. Line pitch side with mark and scribe a line across the easing. This is the cut line for your stair. **PHOTO 7-12.**

MARKING LOWER SIDE OF GOOSENECK FITTINGS

The same easing used to manufacture starting fittings and the upper side of intermediate landing goosenecks is also used on the lower portion of each gooseneck. In one-rise goosenecks this easing is preattached (See *Photo 2-69*) while in two-rise goosenecks it is unattached. To mark one-rise goosenecks, place the straight section of the gooseneck on a flat surface and with the rise side of the pitch block down, mark the tangent point. **PHOTO 7-13.**

Rotate the pitch block 90° to run side down. Line pitch side with mark and scribe a line across the easing. **PHOTO 7-14.**

For two-rise goosenecks, use a framing square as shown to hold the loose easing and follow the same procedures for one-rise goosenecks detailed above. **PHOTO 7-15.**



7-16

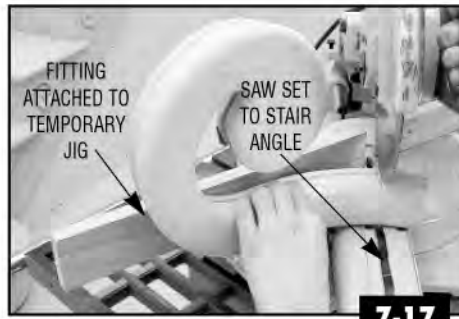

7-17

CUTTING FITTINGS

Once a fitting is marked, it is important to obtain a finish cut that is both square and plumb. The slightest error in this cut will immediately become noticeable after attaching a 12'-16' straight piece of rail. The pitch block can be used to support the fitting, **PHOTO 7-16**, or a temporary jig can be attached to the bottom of the fitting. **PHOTO 7-17**.



7-18

NOTE: It is important to note that there is only one correct cut for each individual stair angle. The miter jig is not arriving at a different point of cut than the pitch block method. However, it does give you a faster and more accurate way to get there with no pitch block to make or keep up with, no marking of the tangent, and no fumbling with awkward cutting procedures.

NOTE: The pitch block method must be employed when using an ascending volute (See Photo 7-74).

STAIR ANGLE CHART

RISE	RUN								
	10"	1/8	1/4	3/8	1/2	5/8	3/4	7/8	11"
7"	35.0	34.7	34.3	34.0	33.7	33.4	33.1	32.8	32.5
	55.0	55.3	55.7	56.0	56.3	56.6	56.9	57.2	57.5
1/4	35.9	35.6	35.3	34.9	34.6	34.3	34.0	33.7	33.4
	54.1	54.4	54.7	55.1	55.4	55.7	56.0	56.3	56.6
1/2	36.9	36.5	36.2	35.9	35.5	35.2	34.9	34.6	34.3
	53.1	53.5	53.8	54.1	54.5	54.8	55.1	55.4	55.7
3/4	37.8	37.4	37.1	36.8	36.4	36.1	35.8	35.5	35.2
	52.2	52.6	52.9	53.2	53.6	53.9	54.2	54.5	54.8
8"	38.7	38.3	38.0	37.6	37.3	37.0	36.7	36.3	36.0
	51.3	51.7	52.0	52.4	52.7	53.0	53.3	53.7	54.0

Top Number = Angle of Stair
Bottom Number = 90° Minus Angle of Stair

7-19



7-20



7-21



7-22

STARTING FITTINGS AND UPPER SIDE OF INTERMEDIATE LANDING FITTINGS

Begin by using the unit rise and run of the stair to determine your angle or pitch. **CHART 7-19** gives you a range of combinations that include most code compliant rise/run combinations. See *Chart 13-3* for a more complete listing of rise and run combinations. Match the rise and run to the corresponding row and column for your stair. Follow the row and column to the intersecting box containing two numbers. The top number will be the angle of your stair. (Example: A stair with a rise of 7-1/2" and a run of 10" will have an angle of 36.9°.)

On a starting fitting or upper side of an intermediate landing gooseneck, the easing will be preattached. The joint formed at this attachment will be the point of reference when using the miter jig to make your cut. Place the Coffman fitting into the cradle of the C-3099, align the glue joint on the fitting with the appropriate angle on the jig, and make your cut. **PHOTO 7-20.**

To make the cut, clamp the jig to your saw with the index mark on the front of the miter jig aligned with your saw blade. The cut can be made with the miter jig sitting upright in a hand miter saw, **PHOTO 7-21**, or laid on its side in a power miter saw. **PHOTO 7-22.**

NOTE: When using a power miter saw, a solid back plate must be attached to keep from cutting the miter jig into two pieces.

LOWER SIDE OF GOOSENECK FITTINGS

To cut the lower easing of goosenecks with the use of Coffman's C-3099 Miter Jig, you must subtract the angle of the stair from 90°. The lower number in each box in *Chart 7-19* will automatically give you this angle. In our example of a 7-1/2" rise and 10" run, $90^\circ - 36.9^\circ = 53.1^\circ$. Align the easing joint of the fitting for one-rise goosenecks to the corresponding angle on the miter jig.

PHOTO 7-23. For two-rise goosenecks use one edge of the loose easing as the reference point. **PHOTO 7-24.**



7-23

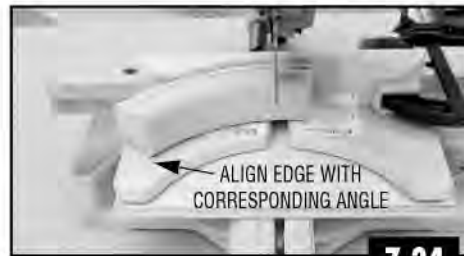

7-24

ATTACHING FITTINGS

RAIL BOLTS

The proper installation of any fitting-to-rail or fitting-to-fitting connection is with a rail bolt (See Chapter 12, Page 4). Rail bolts are 3-1/2" double-ended bolts with 2" of lag (wood) thread on one end and 1-1/2" of machine-screw thread on the other. Each fitting is shipped with the necessary number of rail bolts and 1" tapered plugs for that application. As with all wood-to-wood connections, a high quality carpenter's glue should be utilized. **NOTE:** The use of rail bolts is strongly encouraged in order to meet the "200 lb. side load" code requirements common to national building codes.

Rail bolt installation requires three correctly aligned holes to be bored in the two connecting pieces. **DRAWING 7-25.** Coffman has simplified this process by shipping each fitting with a marking template and by moulding each rail profile with a faint center line groove on the underside of the rail. The marking template is designed to make the marking for rail bolts both faster and more accurate. Simply fold the template on the crease, place over the end of the rail and align the diamond shaped cutout on the moulded center line groove on the bottom of the rail. A mark at the bottom of the notch in either side of the template will provide exact rail bolt hole placement. **PHOTO 7-26.**

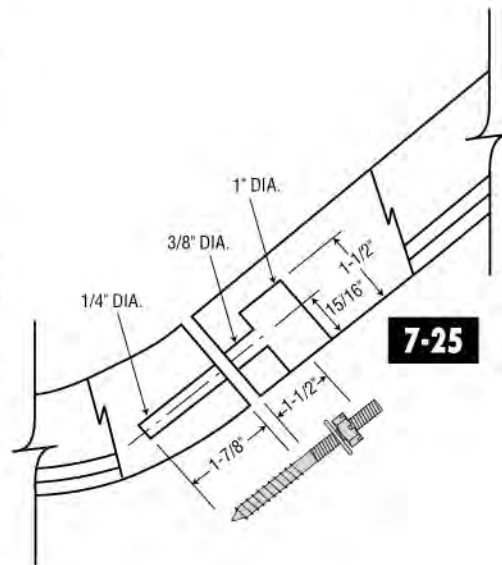

7-25

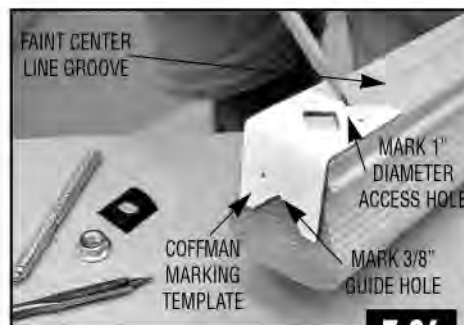

7-26



7-27



7-28

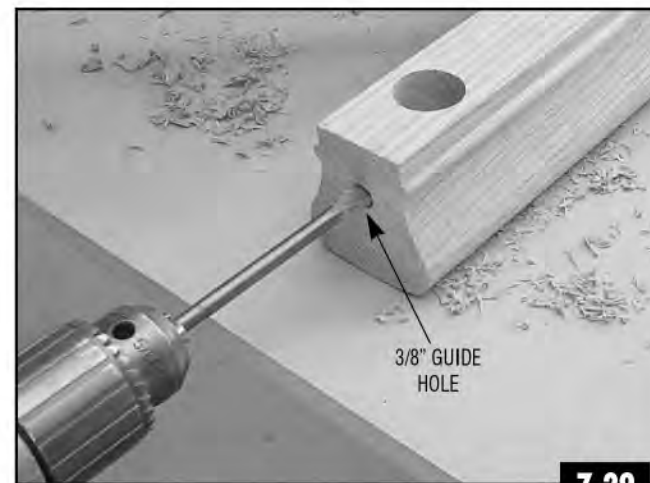

7-29

Begin by marking and drilling a 1/4" diameter hole in the center of the fitting 15/16" up from the bottom.

NOTE: All Coffman fittings that do not normally require trimming are shipped with this hole predrilled. **PHOTO 7-27.**

The marking template should then be used to mark the adjoining holes in the straight piece of rail. In the bottom of the rail, drill a centered 1" diameter hole 1-1/2" from the edge of the rail. This access hole should be approximately 1-1/2" deep. **PHOTO 7-28.**

Next drill a centered 3/8" diameter guide hole 15/16" from the bottom of the rail into the center of the 1" hole. Care should be taken to drill this hole as straight and accurate as possible to ensure correct alignment of the rail and fitting. **PHOTO 7-29.**



Once all the holes have been drilled, use the Coffman C-3901 Rail-Bolt Wrench to insert the rail bolt 2" into the 1/4" diameter hole in the fitting. **PHOTO 7-30.** As an alternative you can use Vise Grips or a box-end wrench and two nuts threaded and locked onto the end of the bolt. Care should be exercised to not damage the machine threads.



Place the inserted rail bolt into the 3/8" guide hole and check the placement of the end of the rail bolt in the 1" diameter access hole. If the end of the bolt is not centered in the hole, run the bolt in or out. The bolt can be bent left or right by placing the nut on the end of the rail bolt and lightly tapping it with a hammer. **PHOTO 7-31.**

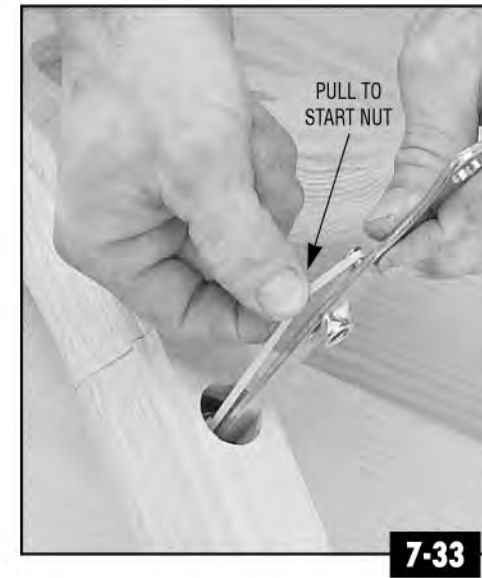
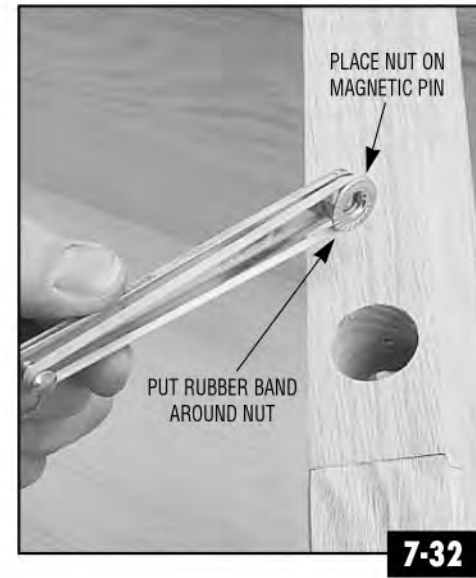

The specially designed half-moon washer, used for increased surface contact in the 1" diameter hole, should then be placed on the rail bolt and the nut should be started. Although this can be accomplished by hand, the Coffman C-3901 Rail-Bolt Wrench makes this task much easier with the use of a magnetic pin and rubber band design. Place the nut on the magnetic pin, apply the rubber band, press the nut firmly against the end of the rail bolt, and pull down the rubber band to start the nut. **PHOTOS 7-32 and 7-33.**

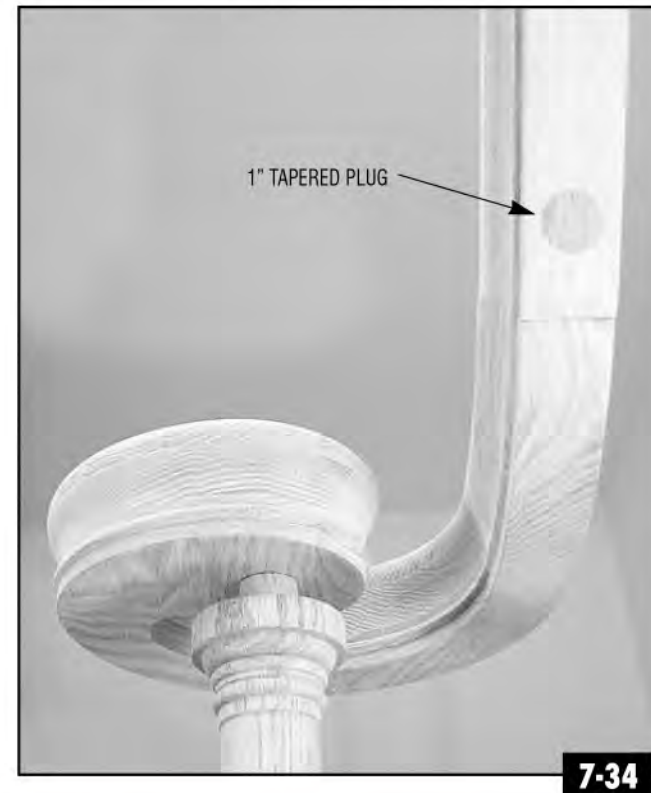

Tighten firmly with the C-3901 Rail-Bolt Wrench or 1/2" box-end wrench and glue the supplied 1" tapered plug into hole. Putty and light sanding completes the job. **PHOTO 7-34.**

TRIMMING A TWO-RISE GOOSENECK

Begin by placing the upper portion of the gooseneck onto the landing or balcony newel and trimming the lower side of the detached easing as described in *Photo 7-24*. **PHOTO 7-35.**

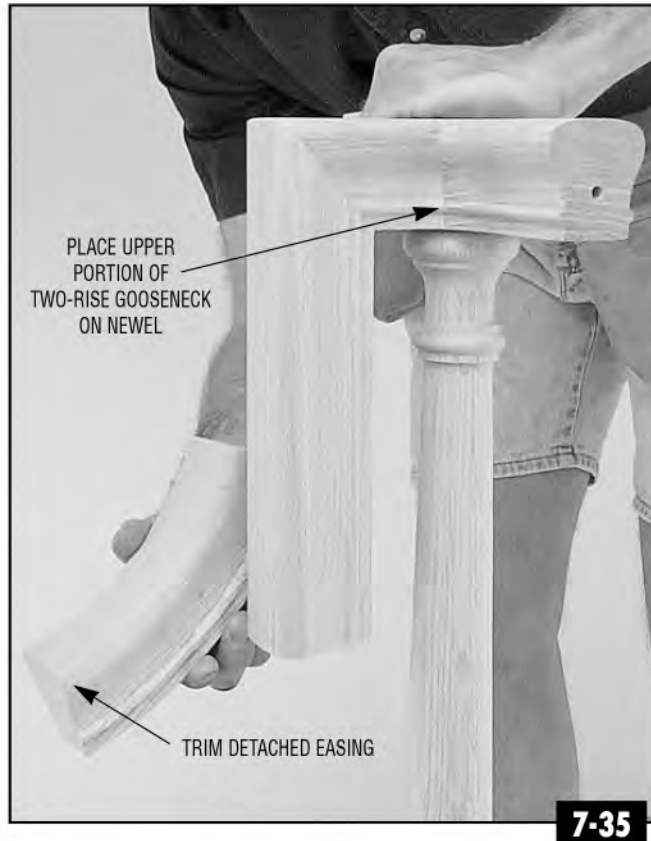

Using no glue, temporarily attach the precut starting fitting to the straight piece of rail and place onto the starting newel. **PHOTO 7-36.**



Measure the rake rail height at one or two of the lower treads and raise the upper end of the rail to the point where the rake rail height is consistent from the top of the stair to the bottom.

HINT: The quickest and most accurate way to measure rake rail height is with a four foot level that has been indexed between 30" and 42". These levels are available commercially or can be made with the use of a permanent marker. Measuring rake rail height is then as simple as placing the edge of the level at the leading edge of the nosing, leveling the bubble, and reading the height at the top of the rail. **PHOTO 7-37.** See *Photo 2-3* for more information on rake rail height.



With the rail shimmed or held to the proper rail height, mark and rough cut an angle through the rail just short of the straight section of the intermediate landing or balcony gooseneck. **PHOTO 7-38.**



With the rake rail height consistent, you must verify that the starting fitting is level and that the rail follows the balustrade center line to the top of the stair. Small variations from either the center line or levelness of the fittings should be corrected by recutting the straight piece of rail to an angle that will achieve the desired result. **PHOTO 7-39.** Larger discrepancies will sometimes occur and will require a recut of the starting fitting.



With the starting fitting and rail properly positioned, tack 6" wide pieces of scrap onto the backside of both the rail and straight section of the gooseneck. **PHOTO 7-40.**



7-41



7-42

With the starting fitting level and the rail properly aligned, place the previously cut easing into the plywood cradle and visually align the easing until both the intersection with the gooseneck and the rail are 90°. A square can be used on one side of the easing to assure accuracy. Scribe the cut lines on both the rail and straight section of the gooseneck. **PHOTO 7-41.** *NOTE:* One-rise goosenecks, with the upper joint preattached, can also be marked in this manner.

Cut and permanently attach the easing to the gooseneck with carpenter's glue, a tightened rail bolt, and a 1" tapered plug (See *Photo 7-34*). Return the gooseneck to the top of the newel and examine the joint between the lower portion of the gooseneck and the rail. Make necessary adjustments and permanently attach the easing to the rail. **PHOTO 7-42.**



7-45

POST-TO-POST GOOSENECKS

Goosenecks used in Post-to-Post applications will be attached directly to the face of the upper square block of the newel and will not require a cap. Begin installation by temporarily attaching the gooseneck to the newel with a Coffman C-3301 Rail & Post Fastener (See *Chapter 12, Page 4*).

PHOTO 7-45. Preparation of the gooseneck at this point closely resembles the instructions for Over-the-Post goosenecks listed earlier.



7-43

At this point, recheck the levelness of the starting fitting. If correct, the starting fitting should then be permanently attached. The Over-the-Post rail system for a straight run stair is complete from the starting newel to the landing newel. The balcony rail requirements can now be addressed. **PHOTO 7-43.**



7-44

NOTE: For stairs with intermediate landings, treat the upper side of the intermediate landing gooseneck as a starting fitting and repeat the process to complete the rail system to the balcony landing newel. **PHOTO 7-44.**

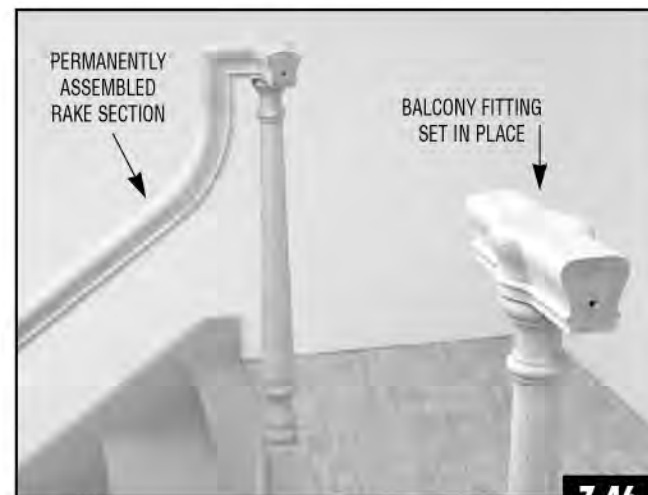

7-46

OVER-THE-POST BALCONY RAIL

With the permanently assembled rake rail section sitting on top of the starting and balcony landing newel, place the fittings for the balcony section on top of the installed balcony newels. **PHOTO 7-46.**



7-47

With the fitting square to the balustrade center line, take a measurement between the fittings and cut a piece of rail slightly long. **PHOTO 7-47.** With the rail held in place between the fittings, note necessary angle adjustments, trim to fit, and temporarily attach with rail bolts. Repeat with each balcony segment until balcony rail requirements are complete.

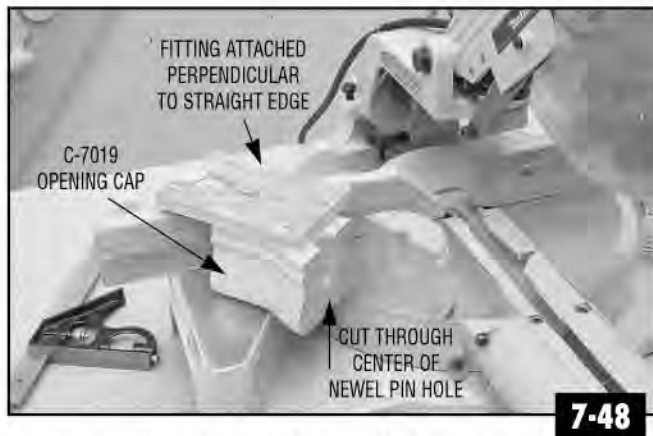

7-48



7-49

OVER-THE-POST RAIL TERMINATIONS

For Over-the-Post rail terminations ending in a half newel, a C-7019 Opening Cap must be utilized to end the rail on top of the newel. On the balcony (*level*) portion of the rail, use a square to attach the fitting perpendicular to a board with one straight edge (See Photo 7-70). Use a chop saw to make a 90° cut through the center of the newel pin hole that is bored on the underside of the fitting. **PHOTO 7-48**. Trim and fit rail between the precut opening cap and adjacent fitting and install with rail bolts. **PHOTO 7-49**.

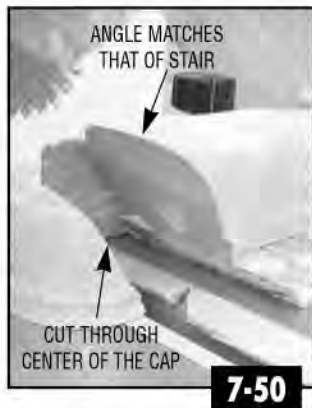

7-50

For Over-the-Post half newels used to terminate a rail on a partial-open stair, the same opening cap must be utilized with special cuts to both the fitting and the half newel. First determine the angle of your stair using the rise and run dimensions of your stair and *Chart 13-3*. Using the same techniques outlined above, use a chop saw and the determined angle to make your cut through the center of the fitting cap. **PHOTO 7-50**.

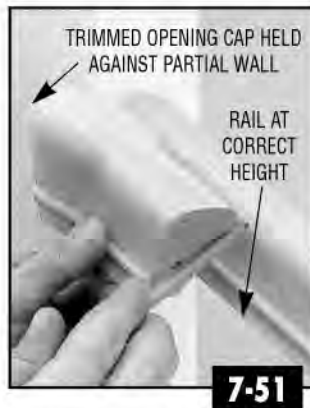

7-51

Attach a straight piece of rail that falls just short of the wall to your starting fitting, shim or hold the rail to the proper rake rail height, and check the levelness of the starting fitting (See Photo 7-39). Align and hold the precut opening cap to the wall and scribe your cut line on the straight piece of rail. **PHOTO 7-51**.



7-52

After completing assembly of the rail and opening cap, mark the wall at the bottom of the fitting and square-cut your half newel to fit this height. Because the angled rail coming up the stair interferes with the top of the newel, a final cut, the angle of which will match the angle of the stair determined above, will have to be made as shown above. **PHOTO 7-52**. The fittings should be glued to the newel and nailed or screwed securely into the solid blocking of the partial wall.

ROSETTES

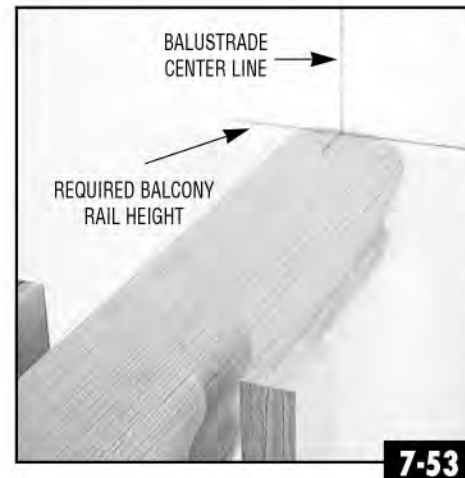

To begin the installation of a rosette, use a 4' level to transfer the balustrade center line of the stair from the tread or landing tread to the wall. Using the required rake rail height, mark the location of the top of the rail. Precut and attach the rail from the last fitting or newel in the system to a point just short of the wall. **PHOTO 7-53**.



7-54

If the rail does not center on the extended balustrade center line readjust the cut at the newel or last fitting. At this point, roll the rosette around the rail as a guide to mark all four sides of the rail. Cutting approximately 1/4" long, adjust your saw angle until it matches the angles marked on the rail. This step will ensure a tight fit between the back of the rosette and the wall. **PHOTO 7-54**.



Once the angle is correct and the rail is trimmed to length, the rosette can then be installed to the rail with two countersunk wood screws through the back of the rosette. **PHOTO 7-55**.

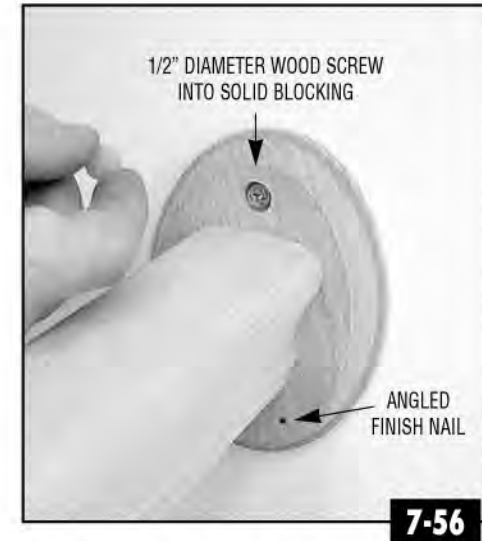

7-56

Final installation should be made into solid blocking with a wood screw covered by a 1/2" tapered plug in the top of the rosette and finish nails driven at opposite angles in the sides of the rosette. **PHOTO 7-56**.

SPECIALTY FITTING APPLICATIONS

As with other fitting-to-rail or fitting-to-fitting connections, the products and applications listed below should be made with the use of a rail bolt (See Chapter 12, Page 4) and carpenter's glue.

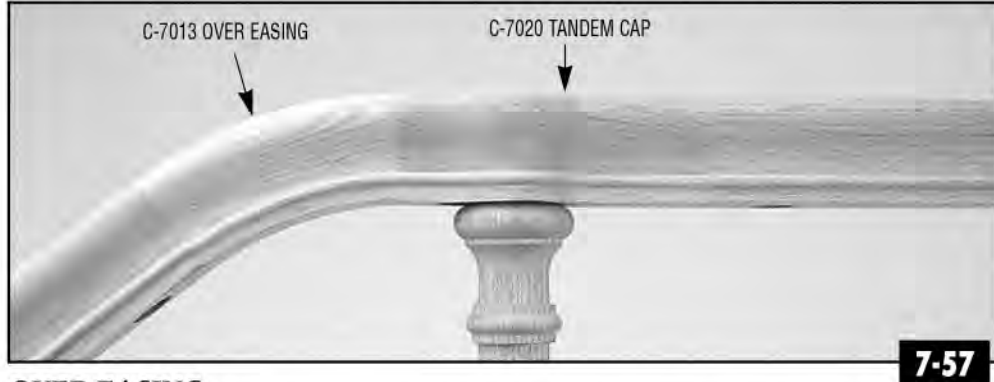

OVER EASING

An over easing is designed to carry the rail system from the rake (*angled*) portion of the stair to the level, balcony portion without the use of a gooseneck. **PHOTO 7-57.** This elegant, flowing look is achieved by combining the over easing with a transitional fitting such as a tandem cap (Example C-7020). Mark and cut the over easing with either the C-3099 Miter Jig (See Photo 7-18) or with the use of a pitch block and framing square (See Photo 7-15).

Note that newel placement must be relocated into the balcony to a point where required balcony rail height will be achieved. With the balcony newel cut to the proper height (See Photo 2-61) place the trimmed and assembled over easing/transitional fitting combination onto the newel. Shim the rail to the correct rake rail height and move the newel back into the balcony until the precut over easing aligns perfectly to the rail. Mark both required newel location and the necessary cut line on the rail and complete installation.

PHOTO 7-58 and **PHOTO 7-59.**

NOTE: The larger the difference between rake rail height and balcony rail height, the further the newel will have to be moved into the stair.

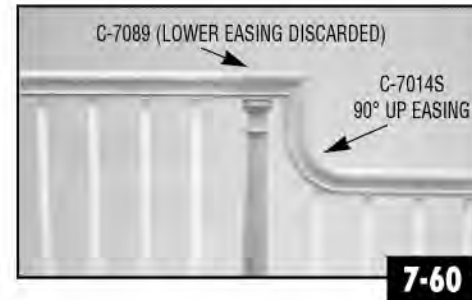
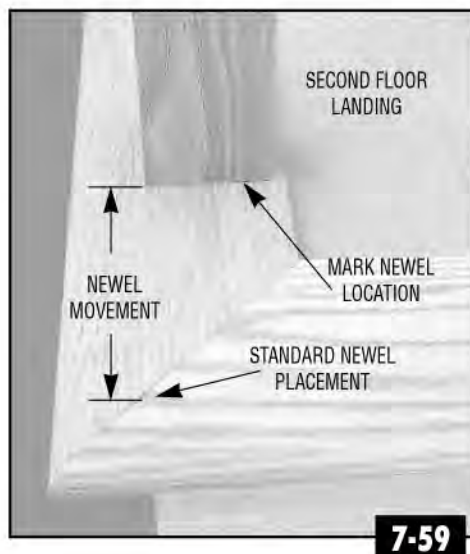

90° UP EASING

90° up easings are used to make a horizontal to vertical 90° transition in a rail system. No trimming is required. **PHOTO 7-60.**

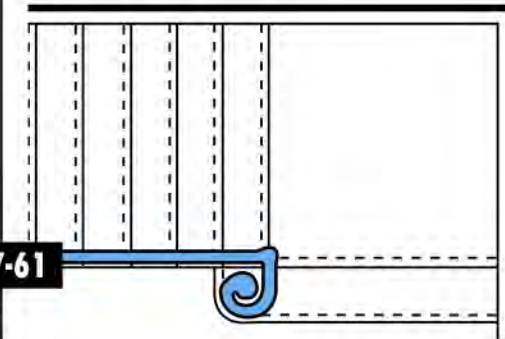
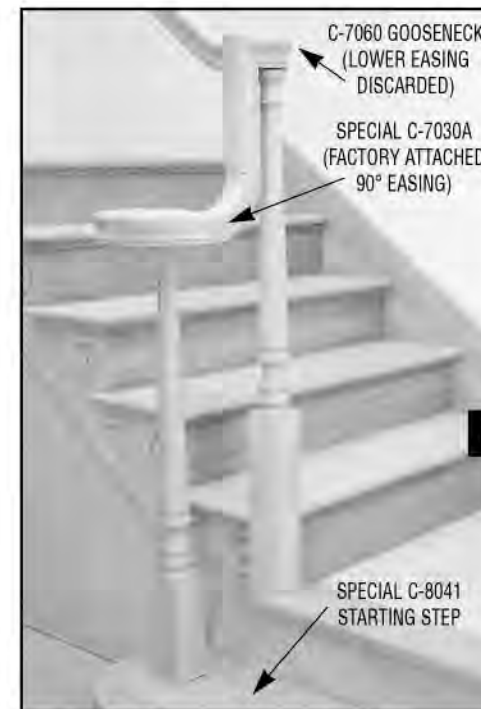

One special application of the 90° up easing is a stair that has two rises (*one tread*) before an intermediate landing. If a volute or turnout is to be used in this application, the horizontal distance between the starting newel and the center line of the straight run above the landing is insufficient for the use of standard starting easings and starting steps. The 90° up easing will replace the standard easing on the starting fitting, the lower easing of the two-rise gooseneck, and the straight section of rail that would normally connect them. A 90° up easing factory-attached to the starting fitting and a special width C-8041 Starting Step are both available from Coffman as special order items. **PHOTO** and **DRAWING 7-61.**



S-SERIES FITTINGS

Coffman's S-Series fittings accommodate the continuous rail codes on partial-open stairs. Ending the rail into a rosette on the face of the partial wall and starting a wall rail inside the wall-to-wall portion is no longer code compliant in some locations. Specify Right-Hand or Left-Hand (*from the bottom of the stair looking up*). **PHOTO 7-62.**

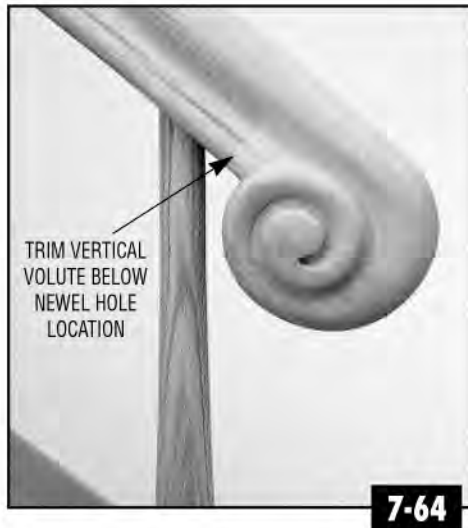
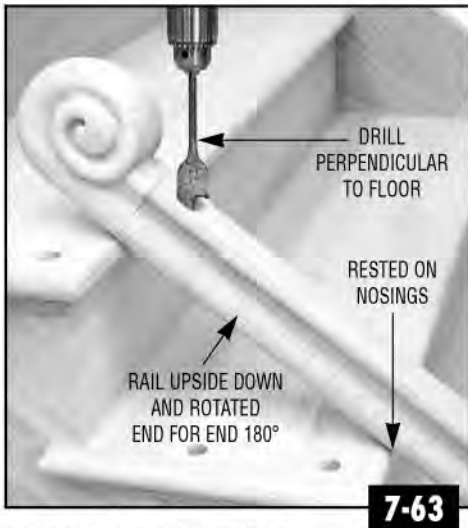

VERTICAL VOLUTES

The installation of vertical volutes usually requires the use of a newel with a tapered top. With the vertical volute attached to the straight piece of rail, turn the rail upside down, rotate end for end 180°, and rest the top of the rail on the nosings of the stair. Drill a hole matching the diameter of the top of the newel into the vertical volute. This hole should be drilled perpendicular to the floor. A drill with a level or a pitch block can be utilized to assure a correct angle (See Photo 8-9). **PHOTO 7-63**. Placement of the hole in the bottom of the volute will depend upon one's personal preferences in the amount of overhang desired in the vertical volute. *NOTE*: The vertical volute must be trimmed at a location which will be below the chosen newel hole location to avoid rail bolt interference. **PHOTO 7-64**.

NONSTANDARD ANGLE CHANGES

Most Coffman fittings are offered directly from the factory in both 90° and 45° (actually 135°) versions for use in transitional and gooseneck applications. Nonstandard angles can be accommodated in one of the following two manners.



COPED ENDS

Some Coffman families contain a Coped End which is a fitting that has the profile of the rail shaped, or coped, into one end of a straight piece of rail. **PHOTO 7-65**. This fitting is used in conjunction with an opening cap (Example C-7019) or a gooseneck incorporating an opening cap (Example C-7097).

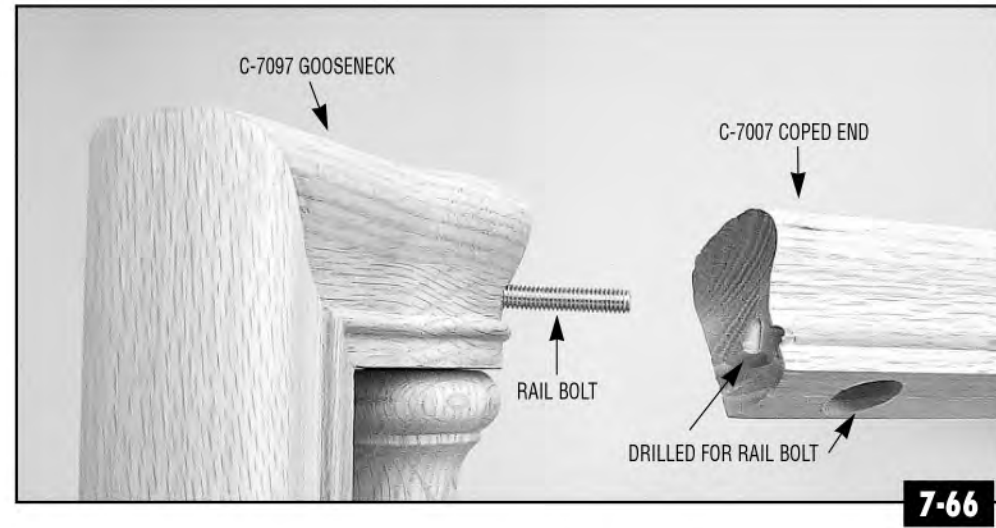

Simply insert a rail bolt into the cap at the desired angle and treat the coped end like the straight piece of rail in a standard rail bolt installation (See Chapter 12, Page 4). **PHOTO 7-66** and **PHOTO 7-67**.

The coped end may also be used at intermediate landings with nonstandard angles. Use a gooseneck that ends in an opening cap (Example C-7097), a coped end (Example: C-7007) and an up easing (Example: C-7012S) to complete the transition. **PHOTO 7-68**.

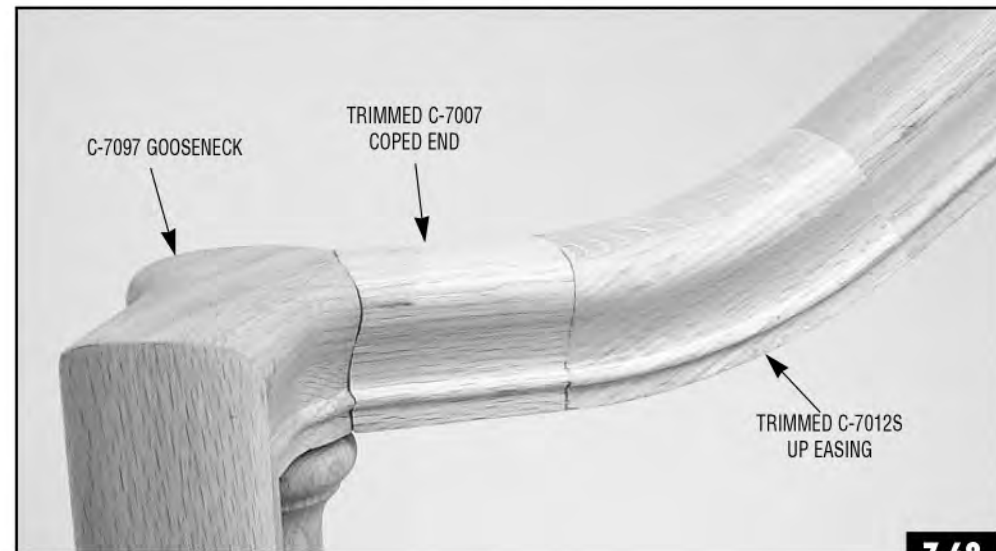

COMBINING FITTINGS

An alternative to the coped end is the cutting and assembly of two opening caps (or one opening cap and one gooseneck that incorporates an opening cap) to make any necessary angle. Subtract the angle of the directional change of your stair from 180° (Example: $180 - 150 = 30$) and divide the remainder by 2 ($30 \div 2 = 15^\circ$) for the angle of cut to be used on each opening cap.

DRAWING 7-69.

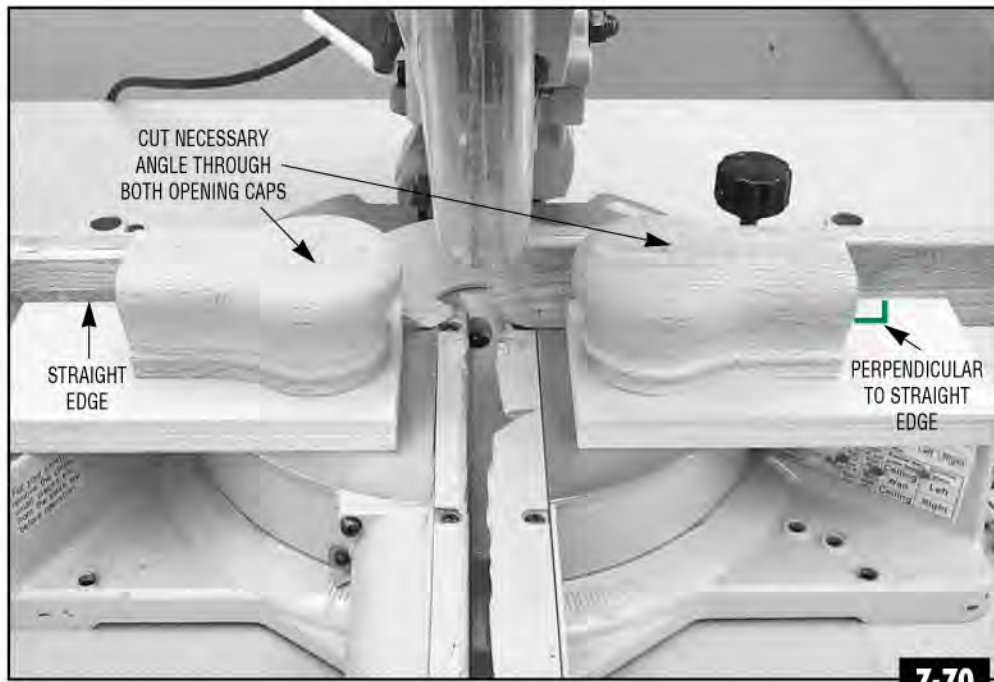
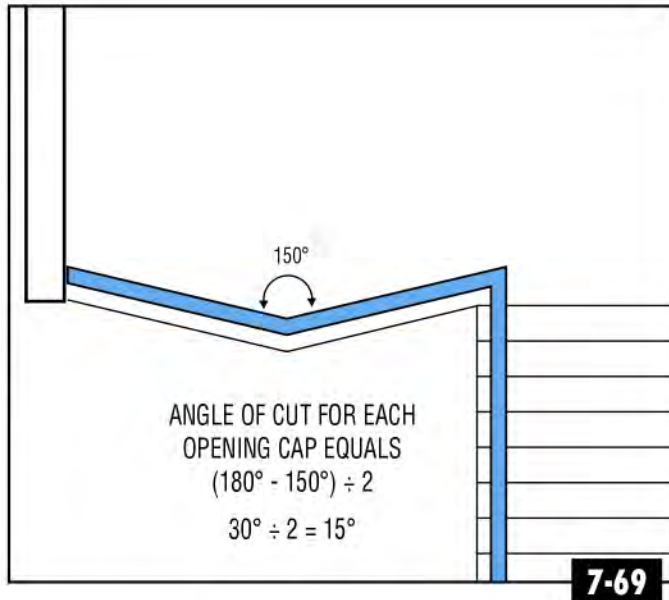

With the use of a square, temporarily attach the caps perpendicular to a board with one straight edge.

Use this temporary jig with a miter saw to cut the necessary angle through the center of the 3/4" diameter newel pin hole bored in the bottom of the fitting. Swing the miter saw to make the corresponding cut in the other opening cap. **PHOTO 7-70** and **PHOTO 7-71.**

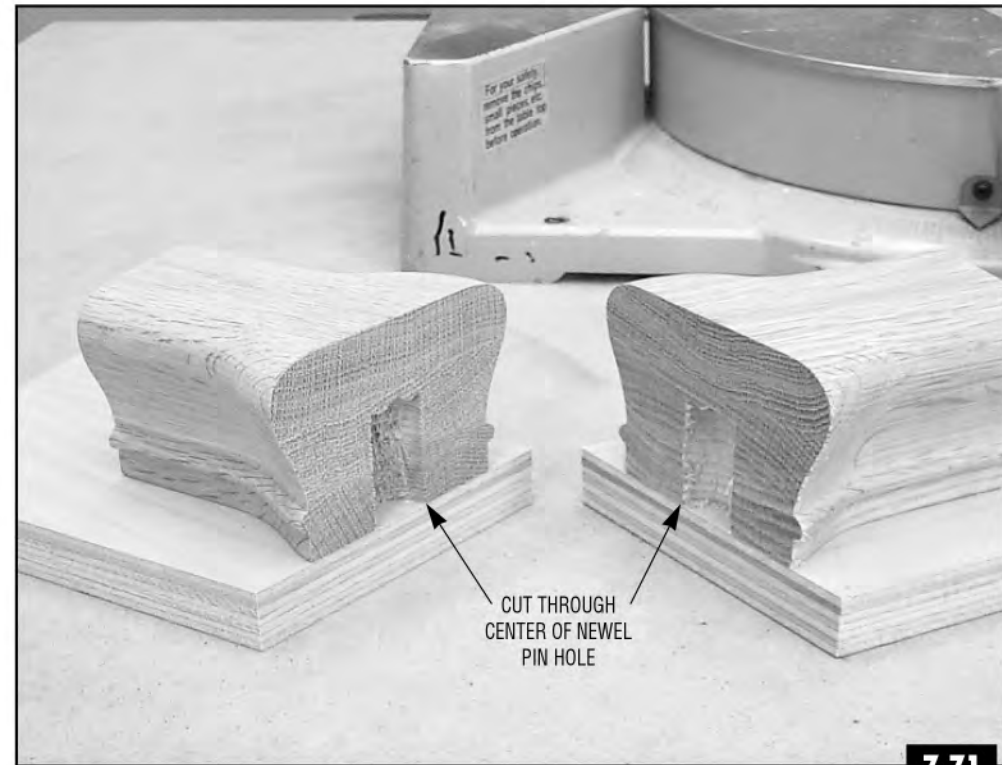

Use clamps and carpenter's glue to pull and hold the caps together. Finish nails driven at opposite angles will complete the job. **PHOTO 7-72.**

ASCENDING VOLUTES

Coffman's ascending volutes (C-7?33, C-7?38) are designed to begin their ascent much sooner than their standard counterparts, allowing for the use of a shorter newel and shorter balusters on top of the bullnose starting step. This lower, more proportional beginning of an Over-the-Post system, coupled with the graceful, flowing transition from the volute to the rail, makes the ascending volute an attractive addition to any stair. The pitch block method will have to be employed in the marking and cutting of ascending volutes (See Chapter 7, Page 5).

PHOTO 7-73 and **PHOTO 7-74**.

See Table 2-58 and Table 2-82 for exact newel and baluster length requirements.

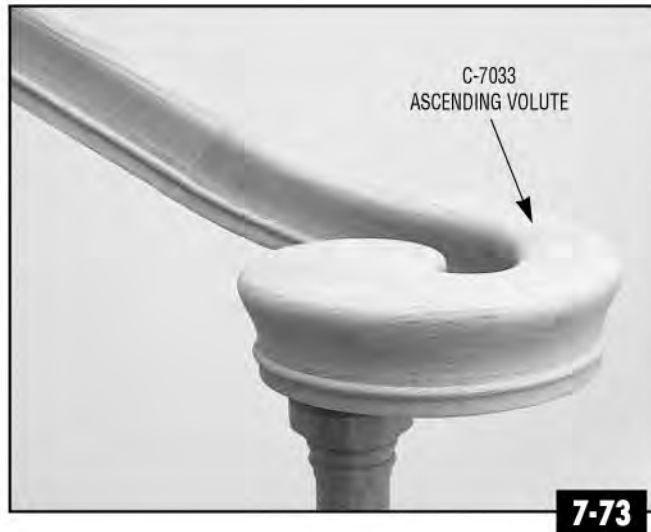

COMBINING FITTINGS

Standard fittings will sometimes have to be site-assembled to complete a height and/or directional transition. Examples are numerous and a complete listing is beyond the scope of this manual. However, basically all stair applications can be satisfied using a combination of currently available Coffman fittings. We recommend that you look closely at the transition and choose the fitting that gives you the desired directional and/or height change. Remember that there will sometimes be more than one option. Two common applications that show both how fittings can be combined and how varying options can exist are shown. As with all rail

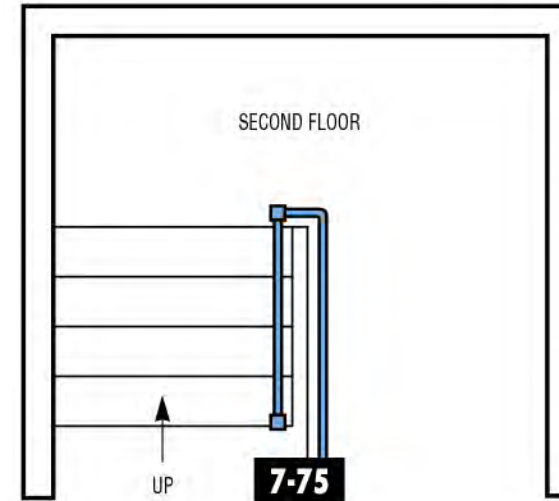

180° TURN AT BALCONY

In the example shown, you will need a two-rise gooseneck with cap that turns right 90° to sit on top of the newel along with a level quarterturn without a cap to complete the 180° turn. **DRAWING 7-75**. These parts can be trimmed to accommodate most center-to-center spacings up to 10" or a piece of rail can be inserted for wider center-to-center spacings.

PHOTO 7-76.



180° TURN AT INTERMEDIATE LANDING

Codes that require a continuous rail from one floor to the next have had a major impact on the design constraints of narrow U-shaped stairs. The two options listed below have constraints that may make one or both options unusable in certain applications. It is important to correctly design and frame a stair with one of the following options in mind.

OPTION 1. Mount the newel at the top of the first straight run. Part requirements are as follows: C-7?81 Two-Rise Gooseneck With Cap, to C-7?11 Level Quarterturn Without Cap (completes the 180° turn), to C-7?12-S Up Easing to start you up the second straight run. The height and location of the newel will have to be adjusted to achieve the required rake rail height on the second straight run. The further the newel is placed into the landing the less height is required of the newel. **PHOTO 7-77.**



OPTION 2. Mount the newel at the bottom of the second straight run. Part requirements are as follows: C-7?13 Over Easing to C-7?11 Level Quarterturn to C-7?14S 90° Up Easing to C-7?65 Two-Rise Gooseneck (detached lower easing to be discarded). **PHOTO 7-78.**

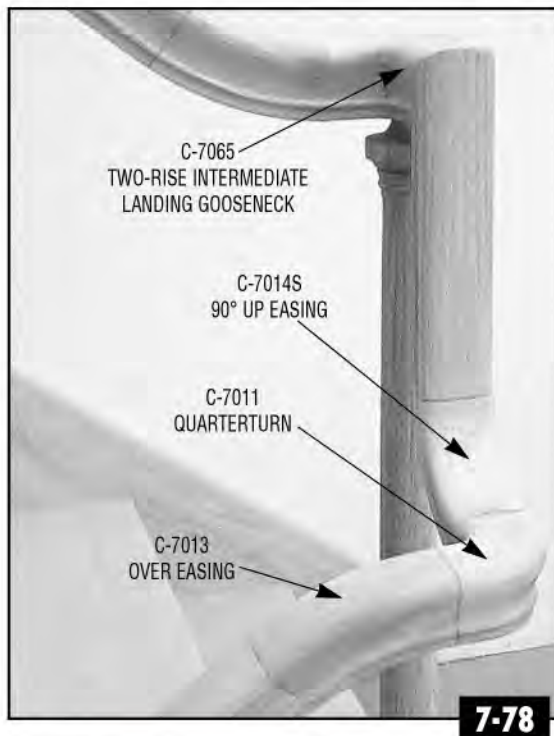

WALL RAIL

All Coffman rail profiles can be used in wall rail applications. **PHOTO 7-79.** Two specialty rail profiles designed exclusively for use in wall rail application are C-6040 and C-6042. **PHOTO 7-80.** Several options providing distinctly different finished looks are listed. Always check the code requirements in your area before proceeding.

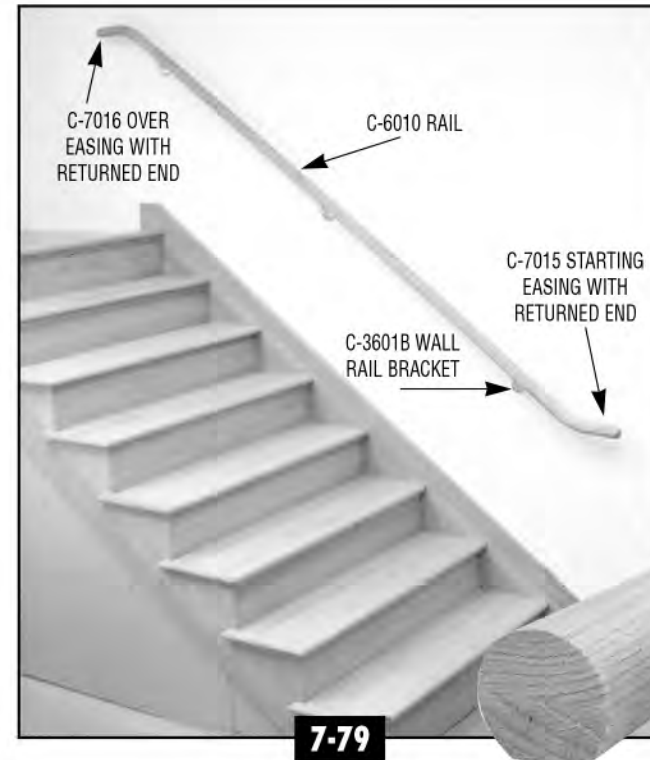

Attachment of wall rails can be made with wall rail brackets. Several options are available from Coffman and all are designed to offer superior support. **PHOTO 7-81.**

Attach the brackets into a wall stud or solid blocking at a height that will result in the required rake rail height. (See Photo 3-33 for information on support blocking). **PHOTO 7-82.** Secure the rail to the bracket with the attachment hardware that is included with the bracket. **PHOTO 7-83.** Standard, fourteen rise straight run applications will usually require four brackets, while the number of brackets used on shorter segments will depend on the length of the rail.

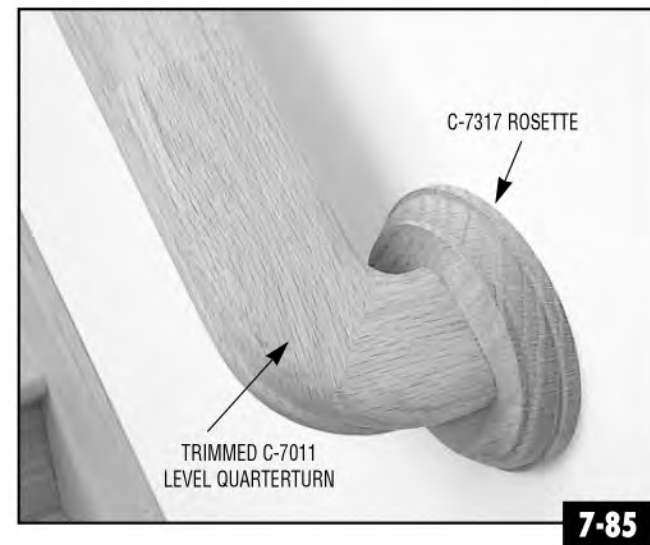
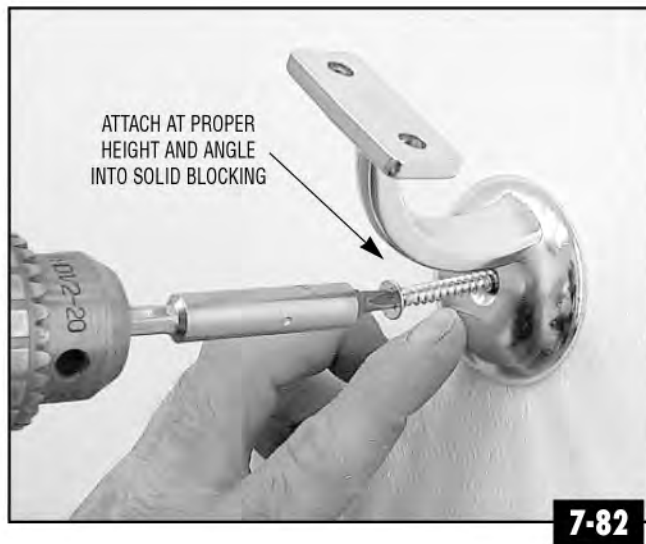

WALL RAIL OPTIONS

A commonly used option for wall rails is the use of a level quarterturn fitting to turn the rail back into the wall. This option requires a level quarterturn and rosette for both the top and bottom of the wall rail. Refer to *Chapter 7, Page 17* for more information on the permanent attachment of rosettes. Wall rail brackets in the interior of the rail will complete the installation. **PHOTO 7-84** and **PHOTO 7-85.**

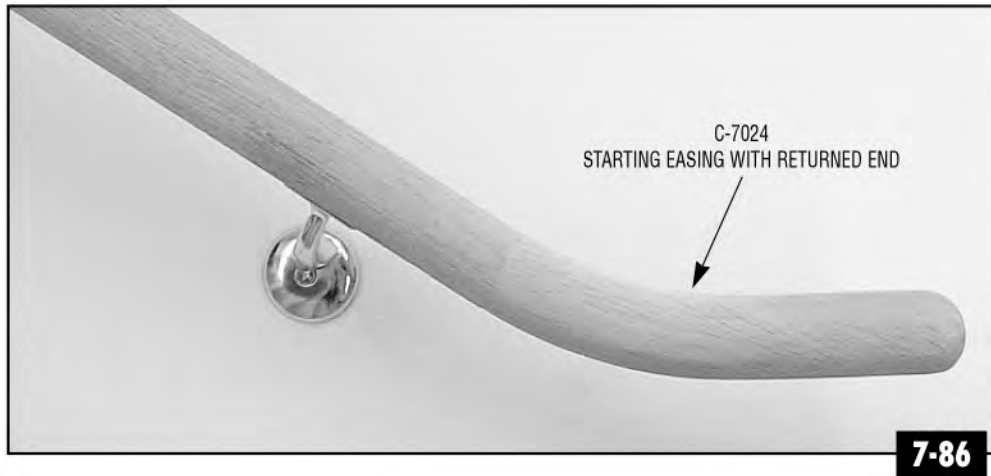

A second option available in some Coffman profiles is the use of specialty starting and over easings. A starting easing with returned end along with an over easing with returned end provides an elegant wall rail that is parallel to the floor at both the top and bottom of the stair. **PHOTO 7-86** and **PHOTO 7-87**.

A third option available for the Traditional (C-6010) and Classic (C-6210W) profiles is the use of the returned end (C-7009 or C-7209W). **PHOTO 7-88**.

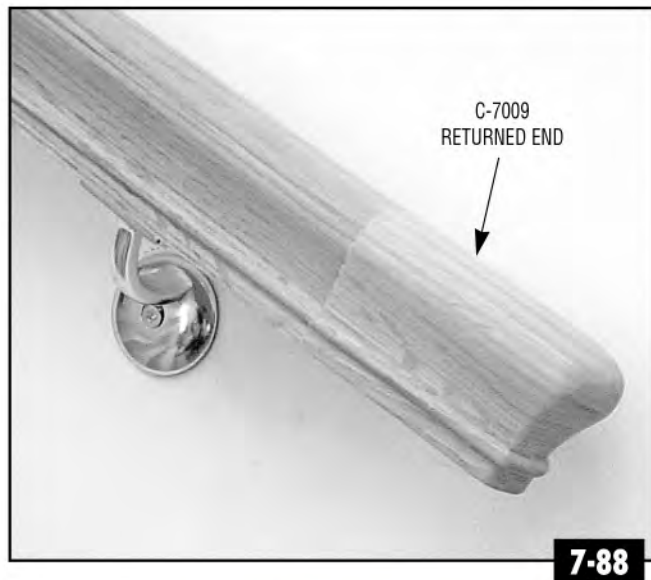

WM Coffman®

BALUSTERS

CHAPTER 8

Balusters

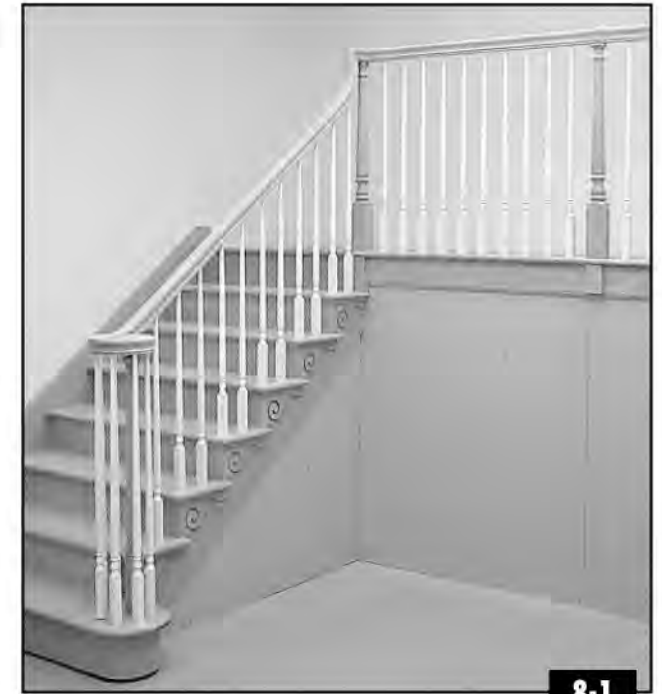

8-1

Once the rail system is completely assembled and temporarily installed throughout the stair, you are ready to address the preparation and installation of the balusters. For safety reasons it is very important that all balusters be securely fastened using proper installation techniques. Under no circumstances should balusters be toe-nailed into either the tread or the underside of the rail as a primary form of attachment. Refer to Chart 2-82 and Chart 2-84 for baluster specifications such as required length and spacing and to Chapter 5 for information on layout and placement.

MARKING BALUSTER LOCATIONS

Begin installation of balusters on the rake, or angled, portion of the stair by marking the center point placement of the individual balusters on all treads. This process is described in detail in *Chapter 5, Pages 2-3*.

PIN TOP BALUSTERS



8-2

When installing pin top balusters, the baluster center points on the treads will have to be transferred to the under side of the unplowed handrail. Use a 4' level to transfer the center point of each baluster to the side of the rail. **PHOTO 8-2.**

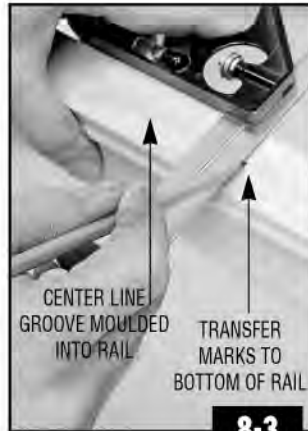

8-3

After the side of the rail is marked for all balusters, a combination square can be used to transfer the marks to the center of the rail. **NOTE:** All unplowed Coffman rails are manufactured with a faint groove moulded into the center of the bottom of the rail, eliminating the need to mark the side to side center at each baluster location. **PHOTO 8-3.**



8-4

At this point you should use a plumb bob at several locations up the stair to ensure that the corresponding baluster marks in the tread and rail are plumb. **PHOTO 8-4.**



8-5

On Over-the-Post systems using volutes and turnouts, you must also locate and mark baluster center points on the underside of the fittings. This can be accomplished by using the same template used to mark the starting step in *Photo 6-3*. This template is provided with all Coffman starting fittings and is printed on transparent paper to assure easy and correct alignment on the bottom of the fitting. **PHOTO 8-5.**

An alternative method is to use a plumb bob to plumb up from each baluster location marked on the starting step.

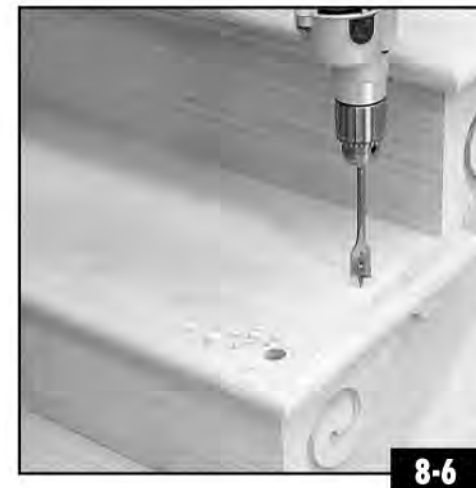

8-6

DRILLING THE TREADS

Most Coffman balusters are manufactured with a 3/4" diameter by 3/4" long dowel pin turned into the bottom of the baluster. This one-piece design allows maximum strength of the installed baluster along with the ease of "standard", time-honored installation techniques. A 3/4" diameter hole should be drilled at each baluster center point approximately 1" deep. **PHOTO 8-6.**

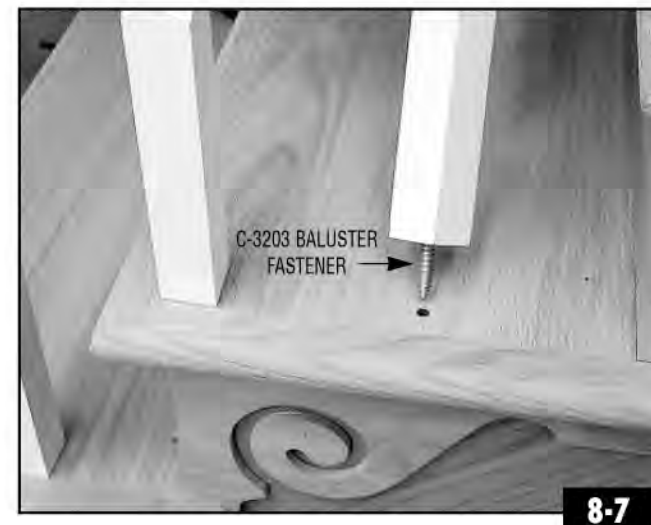

8-7

An alternative to the technique above is the use of C-3203 Baluster Fasteners. These screws have wood threads on both ends and are used to securely fasten balusters to the tread by inserting one half of the screw into the baluster and rotating the baluster into a predrilled hole in the tread. **PHOTO 8-7.** Complete instructions for the C-3203 Baluster Fasteners can be found in *Chapter 12, Page 3*.

DRILLING THE RAIL

After drilling the treads, the rail can then be addressed. It is best to drill a test hole in a scrap piece of lumber to test the fit of the trimmed pin top baluster before using the bit on the rail. Drill bits that are either ground or worn down to a measurement slightly smaller than original size usually create a tighter joint, resulting in a more finished appearance after final installation.

For proper installation, pin top balusters should be inserted a minimum of 1" into the underside of the rail. For this recommended 1" insertion, the baluster hole in the rail should be drilled a minimum of 1-1/2" deep. Use a drill stop or mark the drill bit to make sure that you do not drill through the top of the rail. Baluster holes that fall below a rail bolt should be drilled as deeply as possible and will be dealt with later in the installation process (See Photo 8-16).

NOTE: One of the most difficult problems to overcome in final balustrade assembly is a baluster that bottoms out in the hole drilled in the underside of the rail. Since even the shortest Coffman rails will be approximately 3" through when used in code compliant stair angles, we strongly recommend that you over drill the depth of the baluster holes. **PHOTO 8-8.**

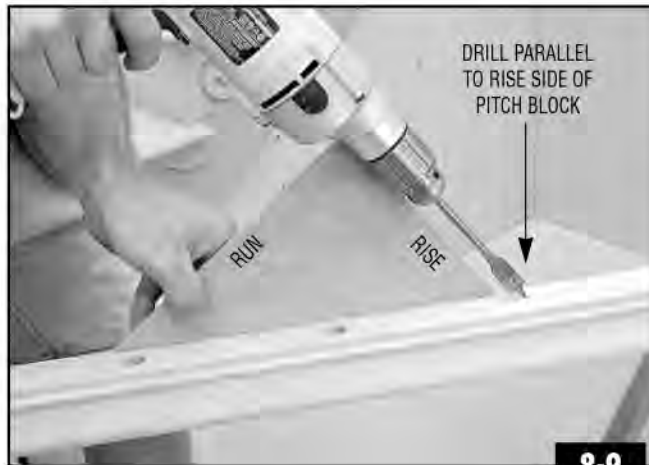

Once a drill bit is matched to the balusters, several techniques are available for ensuring a correctly drilled hole.

A pitch block, representing the rise, run, and angle (*pitch*) of your stair (See Photo 7-10) can be used as a drill guide. With the bit started at the required location, place the angled side of the pitch block on the underside of the rail and drill parallel to the rise side. **PHOTO 8-9.**

NOTE: A third option is the use of commercially available drill guides set at the angle of your stair.

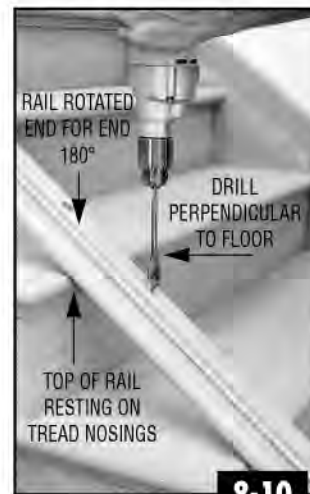
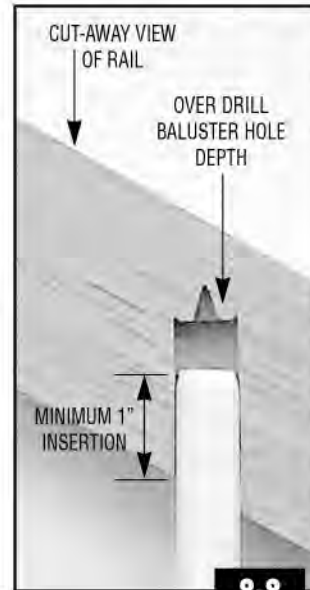

A second method of correctly drilling the baluster holes is to turn the rail over, rotate end for end 180°, and rest the top of the rail against the nosing of the treads. This rotation effectively places the upper portion of the rail at the bottom of the stair and the lower portion at the top. A baluster hole drilled perpendicular to the floor will then work for the angle of your stair. **PHOTO 8-10.**

PHOTO 8-10.



NOTE: When used on Over-the-Post systems, the gooseneck fitting will interfere with laying the rail flush against the tread nosings. In this case, you have two options available that will allow you to use this method without removing the fitting. Either (1) shim the starting fitting to a point where the rail is parallel to the rake of the stair or (2) lay the rail at such an angle to allow the gooseneck to be in the air while the rail still contacts all tread nosings. **PHOTO 8-11.**

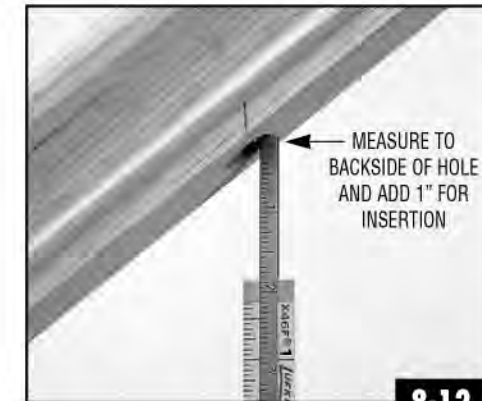

MARKING AND TRIMMING BALUSTERS

With the rake rail drilled and sitting back in place on or between the newels, all balusters should be marked and trimmed to length. Remembering to add 1" for insertion, measure for the front baluster on the lower tread from the back side of the hole drilled in the tread to the upper side of the hole drilled on the underside of the rail. **PHOTO 8-12.**

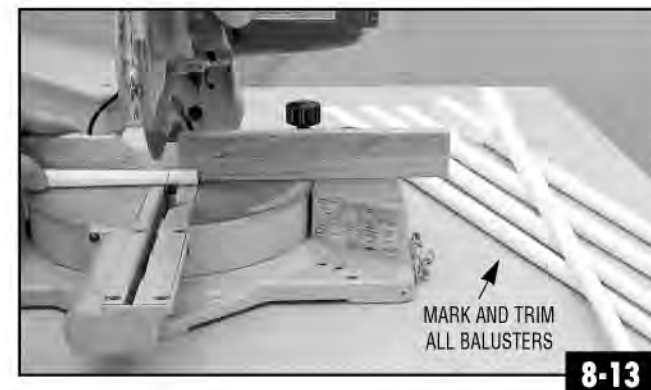

Check heights at several treads throughout the stair to confirm that they are equal and trim the necessary number of front balusters for your job. **PHOTO 8-13.** **NOTE:** Baluster measurements are from the top of the tread and should be applied from the bottom of the baluster square. Repeat procedures with remaining balusters on each tread.



NOTE: On long straight runs of rake rail you must check the rail for any bowing that may occur in the center of the piece. This situation can be identified by measuring for shorter baluster measurements in the middle of the run or by sliding a straight edge up the rail. When recognized, balusters can be cut to the correct length for the entire run and the problem corrected during final baluster installation. **PHOTO 8-14.**



8-15

An alternative to marking and trimming balusters is to lay the necessary balusters for the stair on each individual tread. Each baluster can then be held in place, marked, trimmed, and placed back on the tread to await final installation. **PHOTO 8-15.**



8-17

BALCONY BALUSTERS

When the baluster preparations for the rake portion of the stair are complete, you can then address the balcony. With the baluster center points marked (See *Photo 5-5 and Chapter 5, Pages 6-7*) and the balcony rail system set temporarily in place, the rail can then be marked in the same manner as detailed in the rake rail instructions listed on *Chapter 8, Page 2*. **PHOTO 8-17.** Mark the side of the rail for each baluster using a 4' level, transfer the marks to the center of the bottom of the rail with the use of a square, and recheck their accuracy at several locations with the use of a plumb bob.



8-16

Because all balusters holes that fall below a rail bolt cannot be drilled for the full 1" recommended insertion, you must carefully measure and cut these balusters. Measure the exact distance from the top of the tread to the center of the top of the hole in the rail. Mark and trim the baluster approximately 1/8" short. This will allow maximum penetration of the baluster without the possibility of bottoming out in the top of a shortened hole. **PHOTO 8-16.**

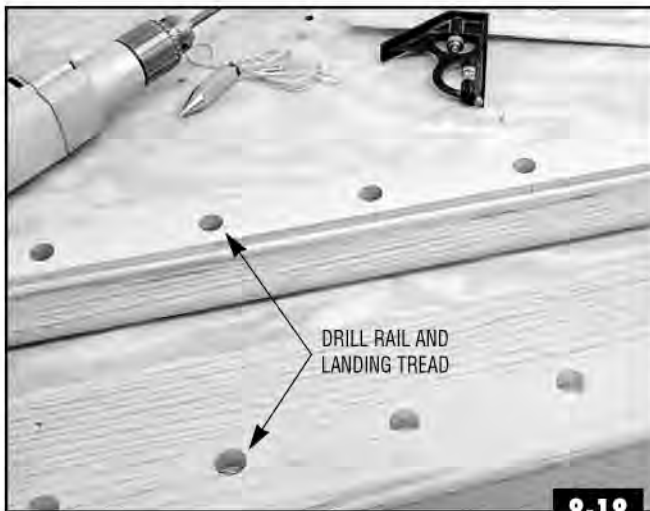

8-18

After marking, remove the rail, lay upside down on a flat surface, and drill a 1-1/2" deep hole with a bit sized exactly to the top of a trimmed baluster. Again, baluster holes that fall below a rail bolt should be drilled as deeply as possible. A 3/4" diameter by 1" deep hole should then be drilled into the landing tread at each baluster center point. **PHOTO 8-18.**



8-19

To complete the preparation of the balcony segment, measure the opening between the top of the landing tread and bottom of the rail, add 1" for insertion, trim all balusters that do not fall beneath a rail bolt, and arrange along the balcony to await final installation. **PHOTO 8-19.**

Balusters that fall beneath rail bolts must be addressed in the same manner as those on the rake (See *Photo 8-16*). Measure the hole opening to the top of the drilled hole and trim the baluster approximately 1/8" short.

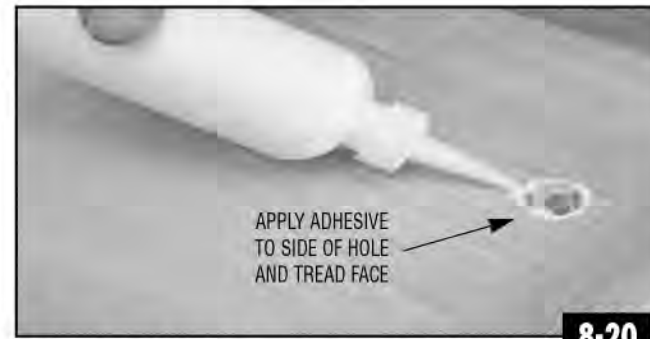

8-20

FINAL BALUSTER INSTALLATION

With the previous steps completed, you are now ready to permanently install the balusters. If the Coffman C-3203 Baluster Fasteners are not employed (See *Photo 8-7*), the 3/4" diameter x 3/4" long pin at the bottom of the balusters will be inserted into the hole drilled into the threads and landing treads. Working one section at a time (*either rake or balcony*), insert construction adhesive or carpenter's glue into baluster holes. **PHOTO 8-20.**

NOTE: To ensure solid installation of the balusters into the treads or landing tread, care should be given to the application of adhesives at the baluster hole. The carpenter's glue or construction adhesive should be applied around the edge of the hole in a manner that will let the adhesive cling to the side of the hole. A small amount of adhesive left on the face of the tread or landing tread will also allow contact with the bottom of the baluster without allowing squeeze-out that could interfere with the finishing of the stair.



8-21

Although carpenter's glue, if preferred, works well in the baluster holes drilled in the treads, construction adhesives are superior for use in the holes drilled in the underside of the rail. The consistency of the adhesive will keep the product in the baluster hole as the rail is rotated and installed onto the balusters. A small amount of adhesive should be placed in each baluster hole. **PHOTO 8-21.**

With the adhesives applied, insert each trimmed baluster into its corresponding location. The system is then ready for the rail to be installed on top of the balusters. **PHOTO 8-22.**

NOTE: Capping the rail onto the balusters can be difficult without assistance. You will find that the extra hands of one or two assistants will make the insertion of the top of the balusters into the rail much easier.



Over-the-Post systems will require carpenter's glue or construction adhesive be applied to the pin and top flat portion of all Over-the-Post newels before the rail is installed. **PHOTO 8-23.**

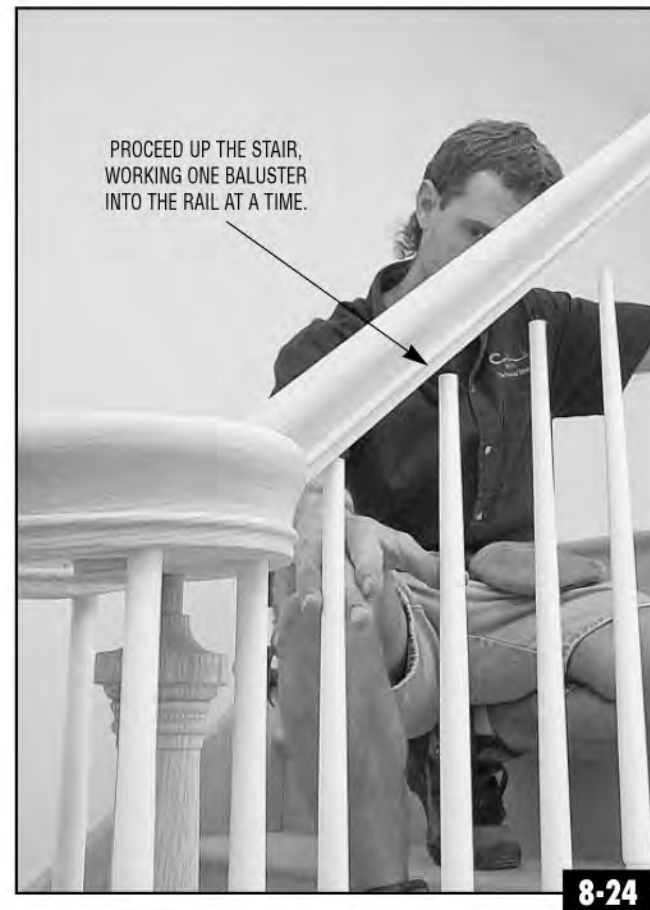
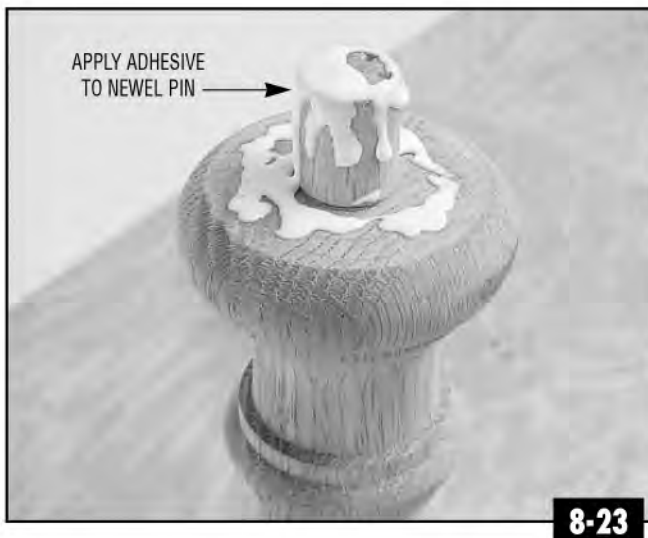

Begin installation of the rail onto the balusters by holding the top of the rail section at a slight angle towards the ceiling. Starting at the bottom of the stair, insert the first few balusters into the rail. **PHOTO 8-24.**

Slowly lower the rail, placing each baluster into the rail as you work your way up the stair. A clear rubber mallet, or a mallet that has been covered with a cloth to prevent the marring of the rail, can be used to help ease the balusters into the rail. **PHOTO 8-25.**



8-26

With all balusters inserted, the rail will then have to be permanently installed to the newels. For Post-to-Post systems, squeeze small amounts of carpenter's glue into the joint at the newels and permanently install. **PHOTO 8-26.**

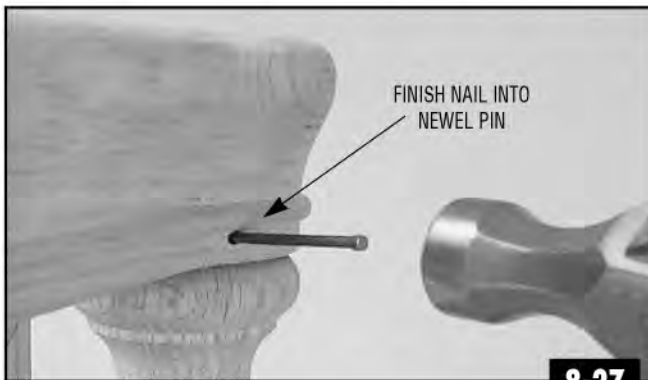

8-27

For Over-the-Post systems, drill a pilot hole through the bottom of the fitting directly into the center of the newel pin. A finish nail, combined with the adhesive applied earlier to the pin, will then securely fasten the rail system to the newels. **PHOTO 8-27.**

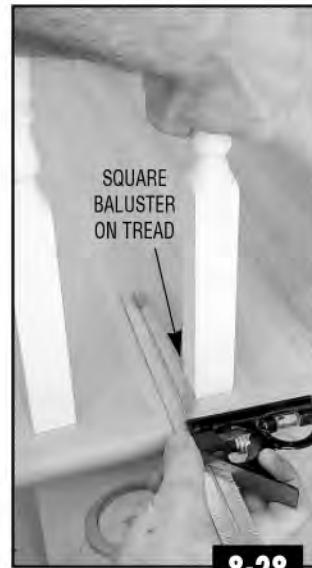

8-28

With the rail attached, check the rail for bowing with a straight edge (See Photo 8-14) and correct with a rubber mallet. A combination square placed against the return of the tread will align the baluster. **PHOTO 8-28.**



8-29

Complete the installation of this segment of the stair by nailing the top of the balusters into the rail with a small finish nail through the upper back portion of the baluster. **PHOTO 8-29.**



8-30

PIN TOP BALUSTERS IN KNEE WALL APPLICATIONS

Installation of pin top balusters into knee walls will require the use of shoe rail and fillet on top of the knee wall. All angle cuts associated with the installation of these products will match the angle of the stair. Use your rise and run dimensions and *Chart 13-3* to determine this angle. **PHOTO 8-30.**

Begin installation of the knee wall balustrade by permanently attaching a piece of shoe rail onto the cap board between the newels. The instructions for Post-to-Post handrail in *Photo 7-2* also apply to shoe rail preparation. **PHOTO 8-31.**

Following local building codes, determine and mark the baluster center points on the side of the shoe rail. For equal baluster spacing, measure the distance along the shoe rail from newel to newel and follow the information and procedures outlined in *Chapter 5, Pages 6-7*. **PHOTO 8-32.**

With the baluster locations marked and the rail temporarily attached to the newels, use a 4' level and combination square to transfer the baluster center mark to the bottom of the rail. Drill the baluster holes into the bottom of the rail and permanently attach handrail as previously outlined.



8-31



8-32

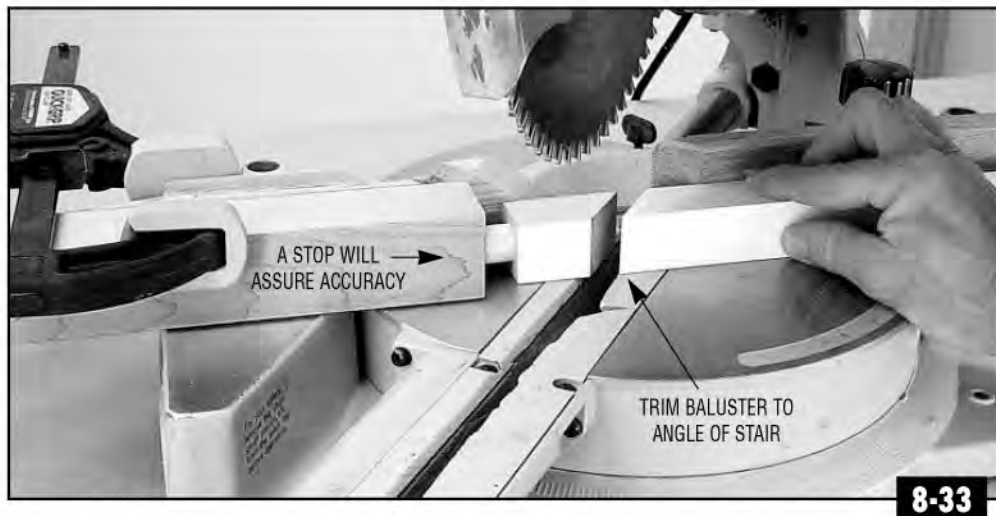

Next trim the bottom of the necessary number of balusters with a chop saw set to the angle of your stair. A stop clamped onto the saw will assist in leaving equal amounts of the square lower portion of the baluster without having to measure and mark each baluster. **PHOTO 8-33.** After trimming the bottom of the balusters, measure the stair for necessary baluster length, add 1" for insertion and trim all baluster tops.



Using adhesives, install each baluster one at a time by inserting the top of the tapered baluster into the baluster hole drilled in the rail and sliding the bottom baluster square into place in the shoe rail. **PHOTO 8-34.** Making sure that the baluster is in line with the center mark previously placed on the shoe, permanently attach with finish nails. **PHOTO 8-35.**



Fillet installed between each baluster will complete the job (See Photo 8-43).



SQUARE TOP BALUSTERS

For proper installation, square top balusters will require plowed rail to accept the top of the balusters and fillet to fill the plow between the installed balusters. All cuts associated with the installation of balusters and fillet will be made with a chop saw set to match the angle of the stair. This angle can be obtained by using your stair's rise and run dimensions and *Chart 13-3.* **PHOTO 8-36.**



MARKING AND TRIMMING BALUSTERS

Prepare the stair for square top baluster installation on the rake portion of the stair by using adhesives and one of the techniques outlined in *Photos 7-4 and 7-5* to permanently attach the rake rail to the newels. Baluster holes in the treads (See *Photo 8-6*) should also be drilled at this time.

Begin installation by inserting the baluster pin into the hole drilled in the tread. **PHOTO 8-37.** With the baluster plumb, scribe a line through the upper block of the baluster along the underside of the rail. **PHOTO 8-38.** The depth of the plow must then be manually added to the line to achieve the final point of cut. **PHOTO 8-39.**

NOTE: To find the exact manual adjustment, purposely cut the first baluster long and trim until the baluster becomes plumb. The distance between the top of the baluster and the original line scribed on the side of the baluster can then be applied to the remaining balusters in the system.

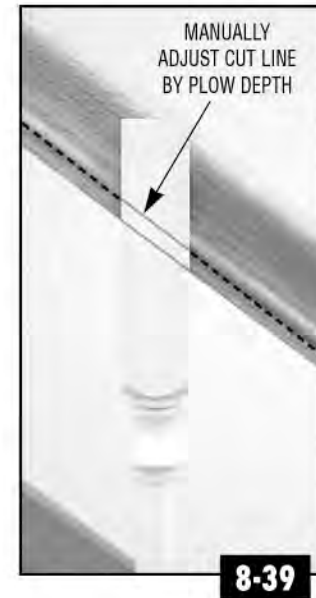

When the baluster is cut to fit and plumb, install using adhesive and finish nails through the upper side of the top of the baluster. Nail holes placed near the top of the baluster will be hidden by the fillet. **PHOTO 8-40.**



After all balusters are securely fastened into place, the fillet can be installed. Begin by making the necessary angle cut on the lower side of a piece of fillet. **PHOTO 8-41.** With the trimmed fillet held against the lower baluster, use the edge of the next baluster in the system to scribe the necessary cut line. **PHOTO 8-42.** Cut the fillet to fit and install using adhesive and finish nails. **PHOTO 8-43.**

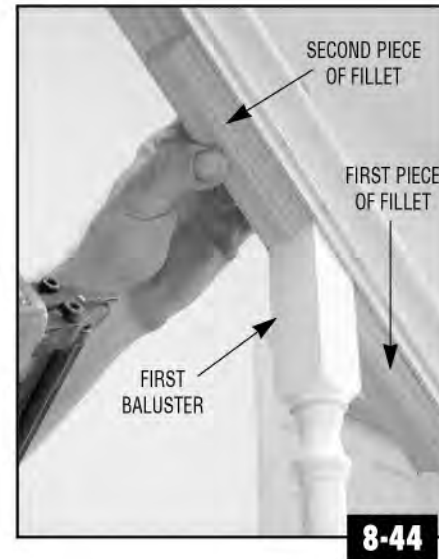
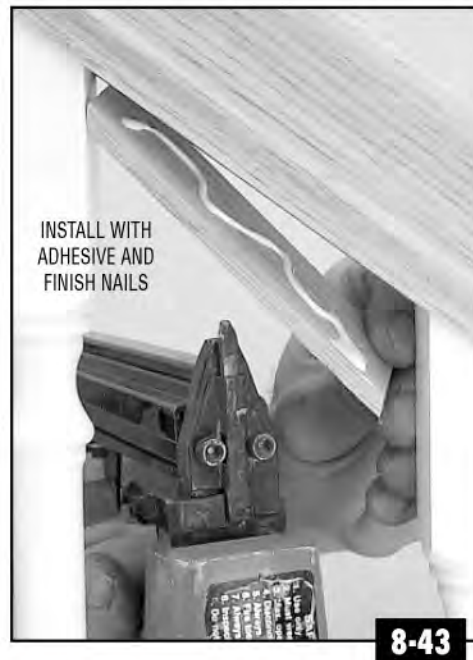
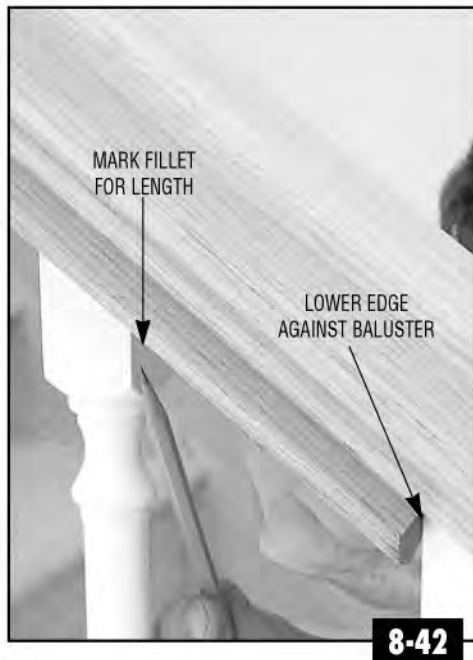
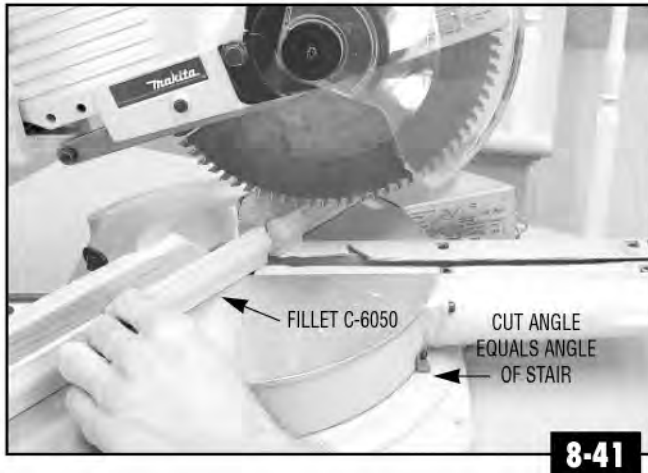

NOTE: A slight variation to installing all balusters before installing the fillet is a fillet-baluster-fillet option. This method first installs the beginning piece of fillet, followed by the first baluster, then the second piece of fillet, effectively completing the stair as you work your way up the rake. Remember to check that all balusters are plumb as you work your way up the stair. **PHOTO 8-44.**



BALCONY BALUSTERS

Upon completion of the rake portion of the system, the balcony segments can then be addressed. Since each baluster within a segment will be cut to the same length, all balusters can be cut to length and installed before the rail is permanently attached.

Measure the length of the balusters for a segment to the top of the plow and square cut the top of the balusters to length. Place adhesive into the baluster holes drilled into the landing tread, set each baluster into place, and permanently install the prefit rail onto the top of the balusters. **PHOTO 8-45.**

NOTE: An alternative is to permanently attach the handrail before installing the balusters. This method allows you to insert one trimmed baluster at a time by placing the baluster pin into the landing tread hole, holding the baluster at an angle, and sliding the top of the baluster into the plow. Although slower, this method works well when assistants are not available or on longer straight runs. **PHOTO 8-46.**

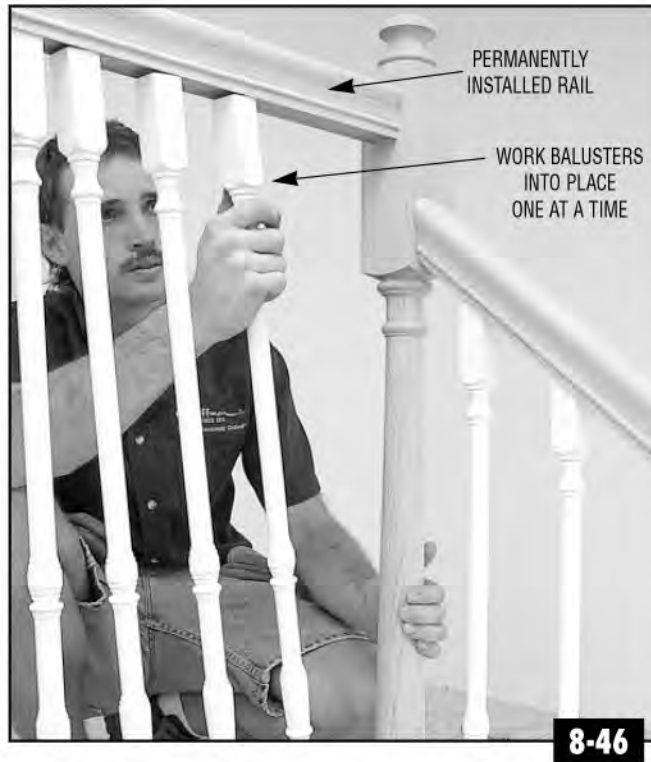

8-46



8-49

SQUARE TOP BALUSTERS USED WITH FITTINGS
 Installation of square top balusters in both Over-the-Post systems and Post-to-Post systems incorporating goosenecks differs from standard Post-to-Post applications because the fittings used with the rail are not plowed. **PHOTO 8-49.** This fact requires that all square top balusters used under volutes, turnouts, or goosenecks be installed before the rail system is permanently attached to the newels.



8-47



8-48

With the rail attached, measure the opening between the square of the newel and the first baluster. **PHOTO 8-47.** Trim a square-cut piece of fillet to length, hold in place with the baluster, and double check the baluster with a level. Install as outlined in *Photo 8-43.* **PHOTO 8-48.** Continue through the balcony segment until all the fillet is installed.



8-50

Balusters under the flat portions of volutes and turnouts can be cut to length and installed into the rail with either C-3203 Baluster Screws (*See Photo 8-7*) or glued and nailed with a 3/4" hardwood dowel inserted between the baluster and starting fitting. **PHOTO 8-50.**

Balusters that fall under the curved easing of goosenecks and starting fittings will require that a radius be applied to the top of the baluster. Every stair, regardless of the angle or the baluster size used, will have a baluster fall upon these easings. To prepare these balusters, set the baluster on the edge of the tread centered with the baluster hole. With the baluster level, use the bottom of the rail to scribe the radius of the curved easing onto the side of the baluster. **PHOTO 8-51.** Trim the baluster and finish sand with a drum sanding tool. **PHOTO 8-52.** With the baluster trimmed and sanded to fit, dowel the top of the baluster with a 3/4" hardwood dowel and install with the other balusters under fittings before permanently attaching the rail. **PHOTO 8-53.** Standard installation techniques outlined previously will then be applicable for the remaining balusters in the stair.



8-51



8-52

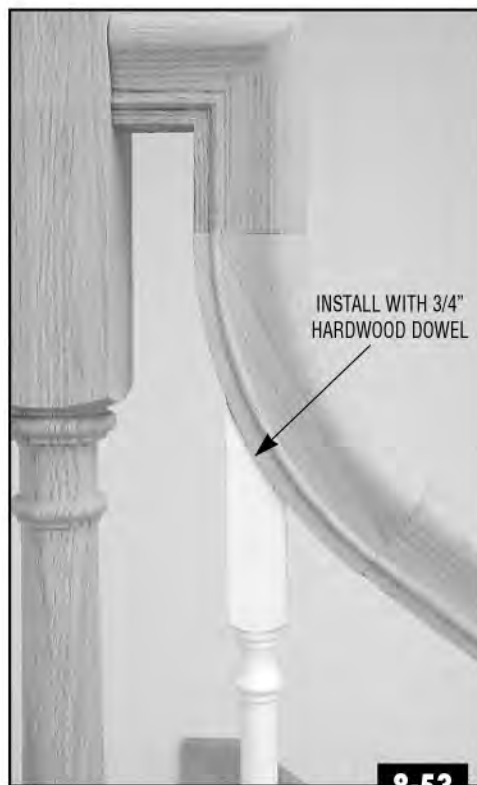

8-53

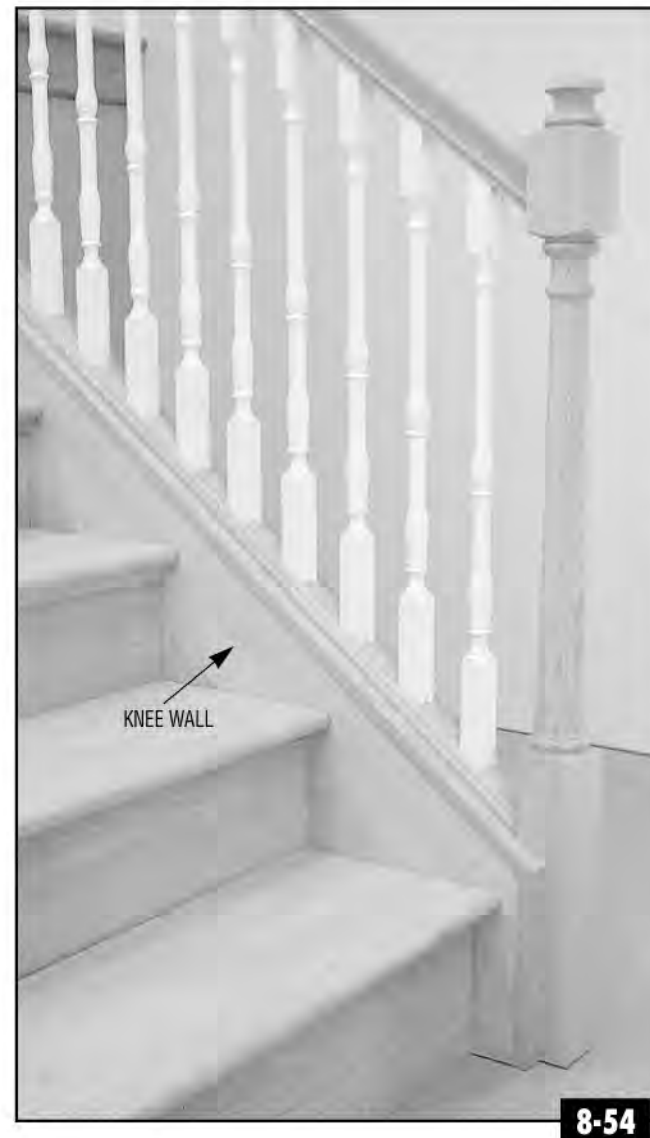

SQUARE TOP BALUSTERS IN KNEE WALL APPLICATIONS

Proper installation of square top balusters on knee walls closely resemble the pin top instructions for knee walls in *Chapter 8, Pages 11-12*. Shoe rail and fillet will be required in addition to the plowed rail and fillet described earlier in standard square top installations. The angle of the cut associated with the installation of these products will match the angle of the stair (*See Chart 13-3*). **PHOTO 8-54.**

Begin installation of the knee wall balustrade by permanently attaching a piece of shoe rail onto the cap board between the newels (*See Photo 8-31*).

Following local building codes, determine and mark the baluster center points on the side of the shoe rail. For equal baluster spacing, measure the distance along the shoe rail from newel to newel and follow the information and procedures outlined in *Chapter 5, Pages 6-7*.

Permanently attach the rail to the newels and prepare the rail as previously outlined. Using a stop clamped to the chop saw, next trim the bottom of the necessary number of balusters (*See Photo 8-33*).

Installation from this point forward applies the fillet-baluster-fillet option discussed in *Photo 8-44* to both ends of the baluster. See *Chapter 8, Pages 13-14* for complete installation instructions on trimming the balusters, trimming the fillet, and suggested permanent installation techniques.

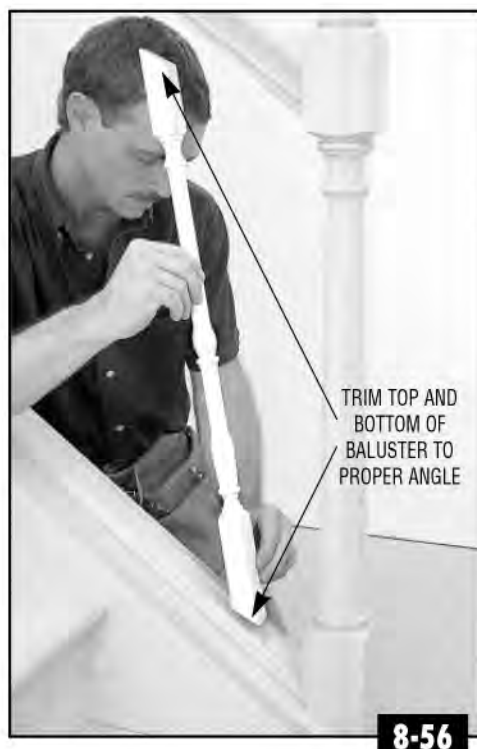

Start by cutting a piece of fillet to the correct length for both the shoe rail and rail and installing them against the starting newel at the bottom of the stair. **PHOTO 8-55.** Trim the angle of the stair on both the top and bottom of the baluster at the necessary length. **PHOTO 8-56.** Permanently install baluster against the edge of the first piece of fillet. **PHOTO 8-57.** The second pieces of fillet in the shoe rail and rail can then be installed above the first baluster. Continue up the stair until the knee wall section is complete.



Because the pieces of fillet should be the same length, you can cut several pieces at one time. Simply place a level against the balusters as you work your way up to stair to verify accuracy. Small variations found at points within the stair can be fixed by recutting or trimming the fillet to bring the balustrade back into plumb.

WM Coffman® CURVED RAIL



CHAPTER 9 Curved Rail



9-1

The installation of curved balustrades, while more complex than standard balustrades, is a process that can be mastered with the tips and techniques outlined in this chapter.

The key components of curved rail construction are bending rails and bending moulds. Bending rail is most easily understood when imagining a standard rail profile cut into thin, vertical strips. Bending mould is a form, moulded to the outside profile of the handrail, that is used to cradle the bending rail as it is being shaped to the stair. The strips comprising the bending rail, along with the bending mould, offer the ability to glue and bend the rail into a radius to match the design of most curved balustrades. **PHOTO 9-2.**

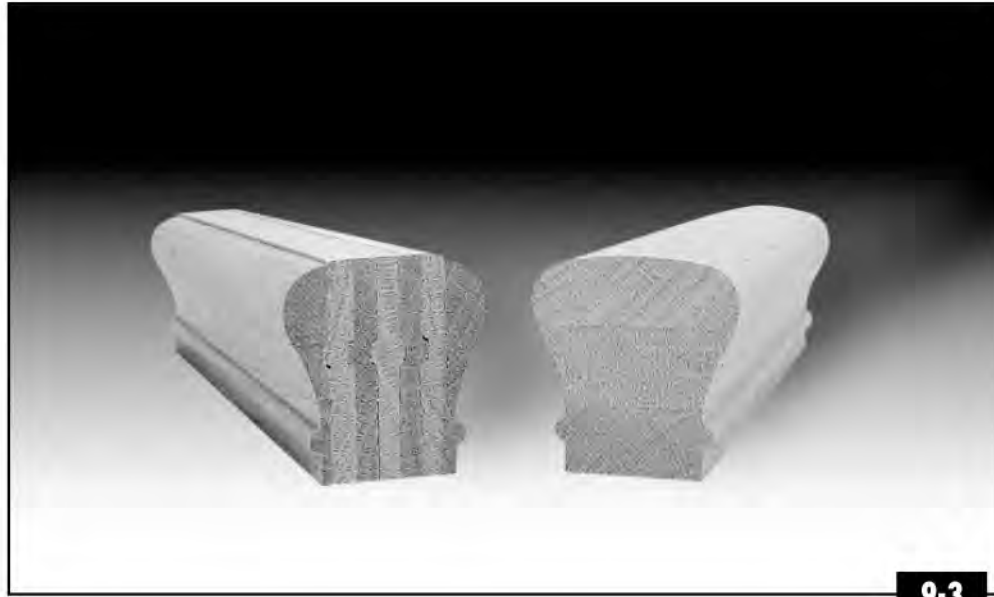
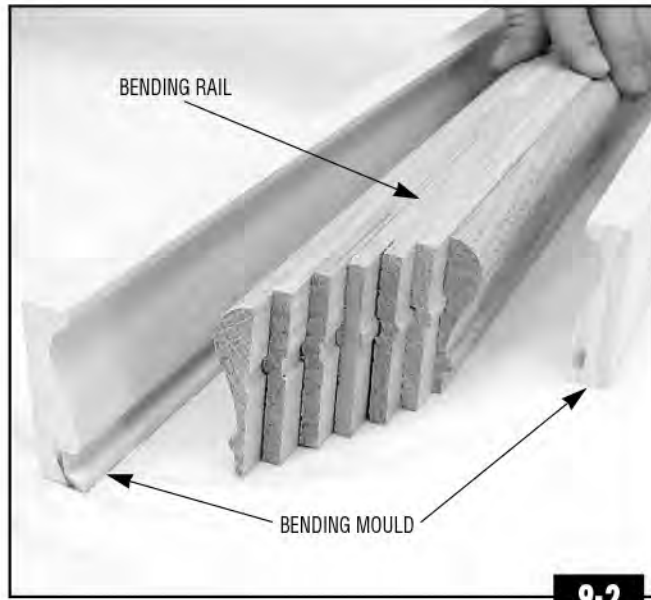

Each ply comprising the bending rail is designed and manufactured with a tongue and groove bead to create an alignment of the plies. This design results in a match of the standard rail profile when the product is assembled. **PHOTO 9-3.** When the rail is formed into the permanent shape to match the stair, installation then becomes as simple as applying the standard balustrade installation techniques discussed in earlier chapters.

BENDING RAIL MINIMUM RADIUS		
RAIL ITEM	RAKE RAIL	BALCONY RAIL
<p>C-6016 Bending Rail</p>	36"	42"
<p>C-6116 Bending Rail</p>	42"	48"
<p>C-6216-W Bending Rail</p>	42"	48"

The minimum radius achievable with each rail profile will depend on several factors. These factors include such variables as the thickness of each ply, the overall thickness of the handrail, the height of the handrail, the angle of the stair, and whether the rail is bent on the rake or on the level portion of the stair. The minimum recommended radius for use on both rake and level applications are listed in **CHART 9-4** for each Coffman bending rail profile.

NOTE: A tighter radius than listed in *Chart 9-4* can be accomplished with bending rail in a certain percentage of installations. However, because the outcome of individual attempts at bending rail to a tighter radius cannot be accurately predicted, the recommendations should be followed to assure a successful bending rail installation.

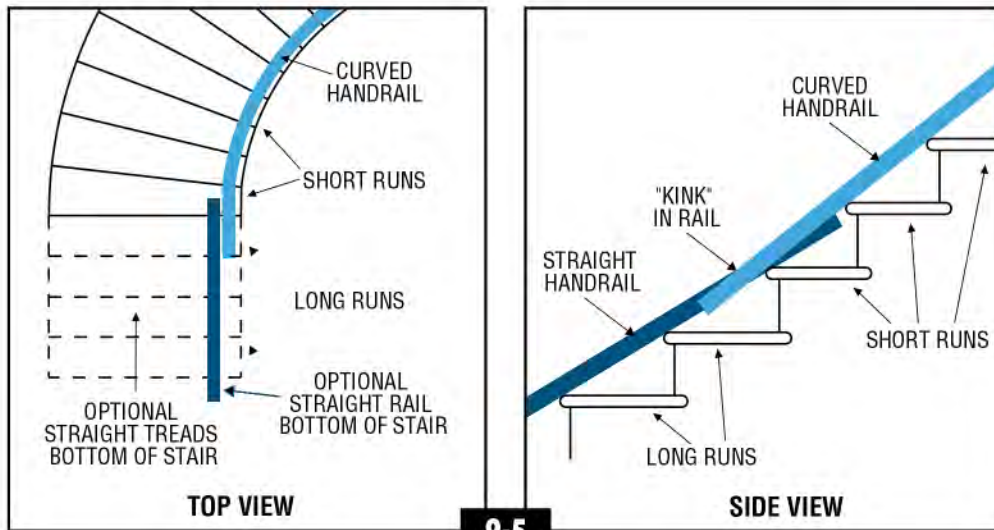

9-5

Before attempting to install any bending rail, it is important to note that the layout of the stair must contain consistent rise, run, and radius dimensions. Uneven rise and run dimensions will create different angles in the stair which bending rail alone cannot accommodate. These angle changes will result in “kinks” in the rail system that are both unsightly and difficult to install. **DRAWING 9-5.**

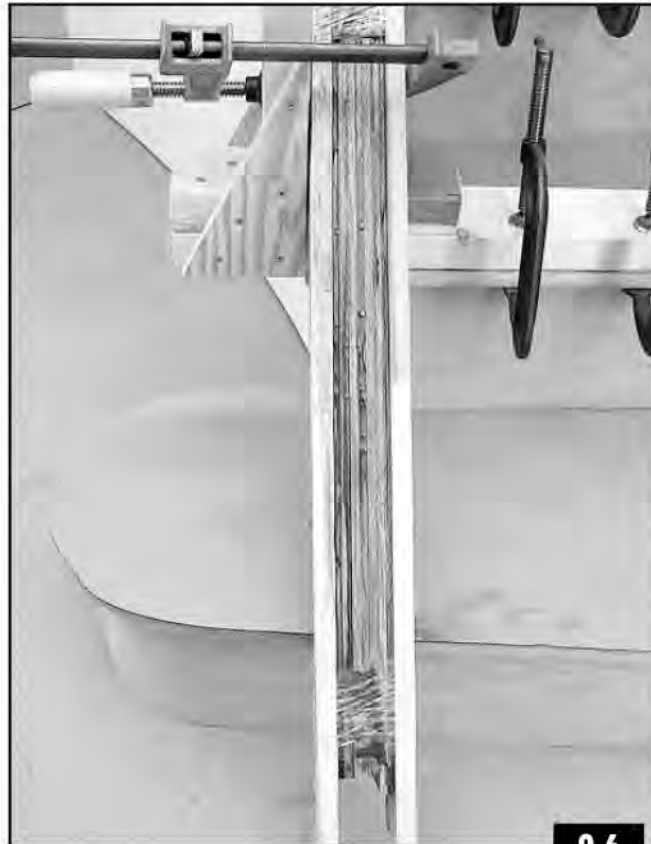

9-6

When ordering components for a curved balustrade, remember to order additional bending rail for excess at both the top and bottom of the stair (approximately 2' total). **PHOTO 9-6.** Bending mould will be ordered in double the quantities of bending rail to allow the bending mould to be used on each side of the rail.



9-7

CURVED RAKE RAIL
Like all balustrade installations, the first step and most important consideration is the location of the balustrade center line. Standard location of the balusters on a curved stair, like that of a standard straight stair, will result in the side face of the baluster lining up with the outside edge of the skirtboard. **PHOTO 9-7.** See Chapter 5 for more complete information on locating balustrade center lines.



9-8

When the center line is determined, the location should be marked on the nosing of each tread. **PHOTO 9-8.**

BENDING GUIDES

At this point you will need bending guides. Bending guides are L-Shaped brackets that when used together, create a form to clamp the bending rail to while waiting for the glued rail to cure to the necessary radius. Guides will be needed for each tread in the system and can either be manufactured at the job site with commonly available materials or made out of welded metal. Built correctly, either type will be strong enough to resist the tension of the bent rail and will be reusable over a number of installations. **PHOTO 9-9.**

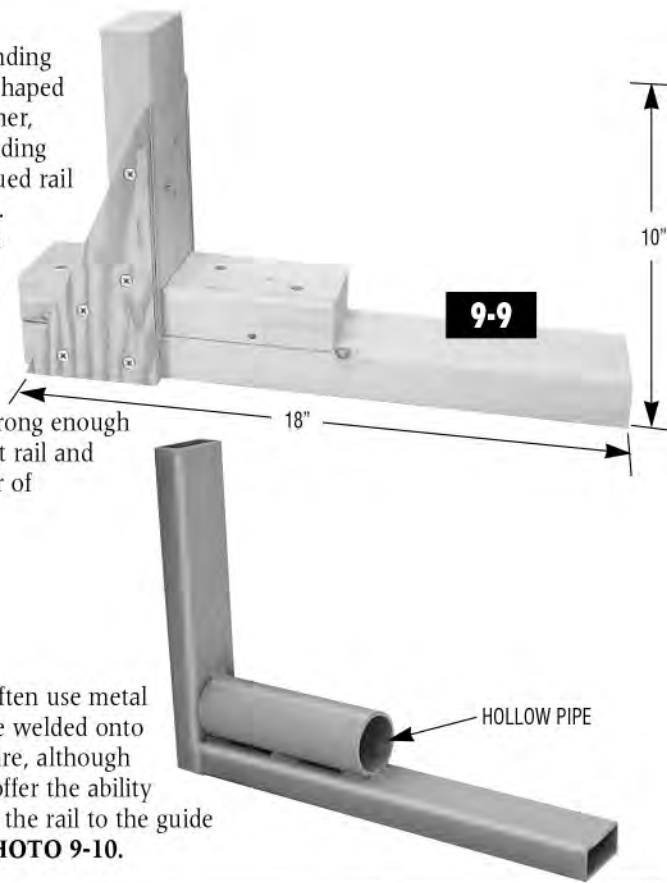

NOTE: Professional installers often use metal clamps that have a hollow pipe welded onto the top of the guide. This feature, although not absolutely necessary, will offer the ability to use a clamp to securely pull the rail to the guide during the bending process. **PHOTO 9-10.**

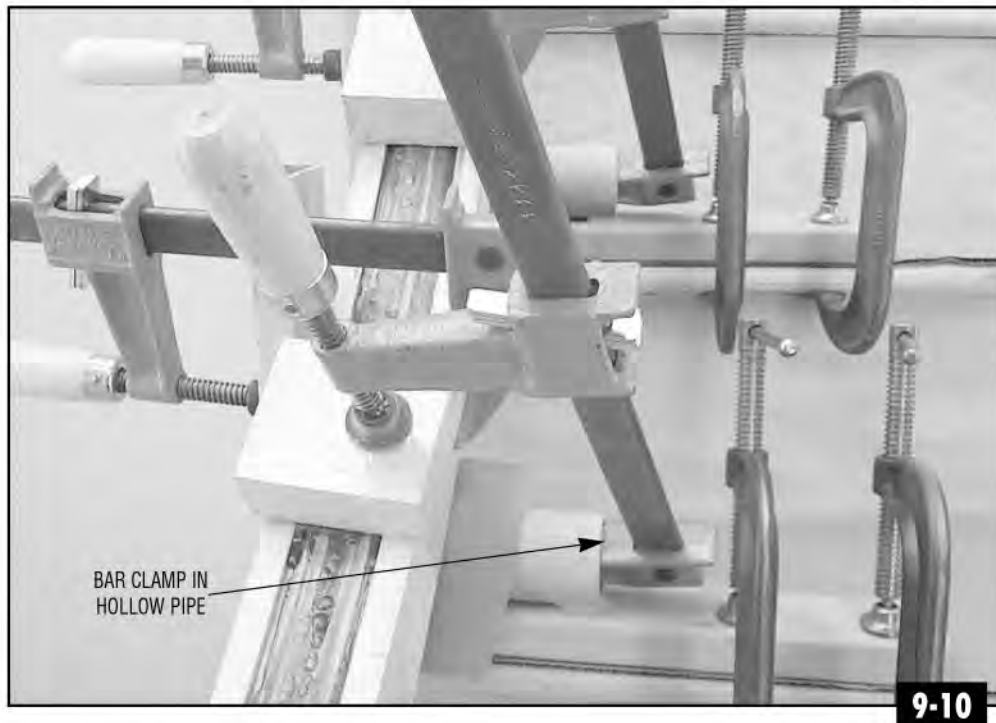

Because it is much easier to pull, rather than push, the rail to the guides during the clamping process, inside and outside curves will require different guides. **PHOTO 9-11.**

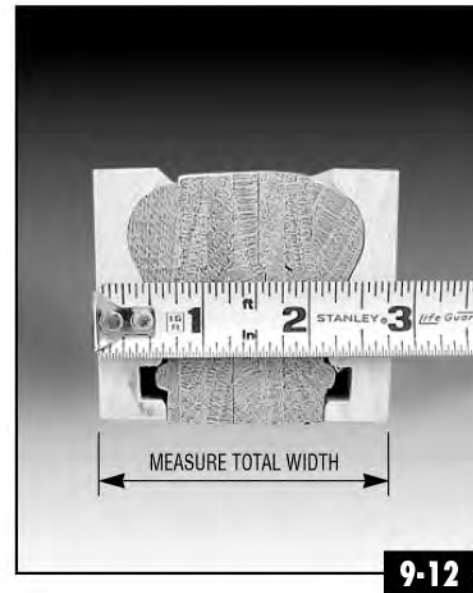

With the bending guides available you must then locate the correct position on the stair to install the guides. Begin by measuring the thickness of the bending rail with the bending moulds attached. **PHOTO 9-12.** Measured from the edge of the vertical portion of the guide, one-half of this measurement should then be marked on the side of the bending guide. **PHOTO 9-13.** With all guides marked, you are now ready to install the guides to the stair. (See "Accounting For Spring-Back" detailed on Page 9-8).

ACCOUNTING FOR SPRING-BACK

"Spring-Back", the expansion of the radius of the bent rail due to the inherent tension when it is removed from the guides, is an occurrence that is very hard to precisely predict in actual job site applications. **PHOTO 9-14.**

Factors that contribute to spring-back include the radius of the stair, the angle of the stair, the thickness of the individual plies, the overall thickness of the rail, the characteristics of the chosen adhesive, the densities of the wood in the particular specie of bending rail, as well as numerous other uncontrollable contributing factors. *Generally speaking, C-6016 bending rail, at 2-1/4" wide and 7 plies, should be able to be bent within specifications with approximately 1/16" spring-back per tread.* As contributing factors increase, especially a tighter radius that approaches or exceeds the recommendations and increased thickness of plies, spring-back will increase. To account for spring-back, align the mark on the middle bending guide exactly on the balustrade center line mark placed on the middle tread and divide the expected spring-back by the number of treads above or below the center guide. In an example of a 13 run stair, the center guide would be set on the seventh tread. Expected spring-back of 3/8" would require the first guide above center to be set 1/16" back from the center line, so as to increase the bend in the rail. The second guide above center would be moved 1/8", the third 3/16", etc. until the 3/8" was achieved on the final tread.

PHOTOS 9-15. The process would then be repeated on the lower half of the stair.



Making certain that the front edge of the guide is flush with the front of the tread, secure all guides in the system. Securely attach using lag bolts in temporary treads or clamps attached to the nosings of finished treads. **PHOTO 9-16.**



NOTE: Cardboard coverings will help catch the adhesive squeeze-out that occurs during the clamping of the rail and will also prevent the marring of the finished treads, if already installed, during the installation process. Small pieces of cardboard placed on the bending guide itself will also aid in keeping the bending guides free of buildup adhesive from multiple uses. **PHOTO 9-17.**

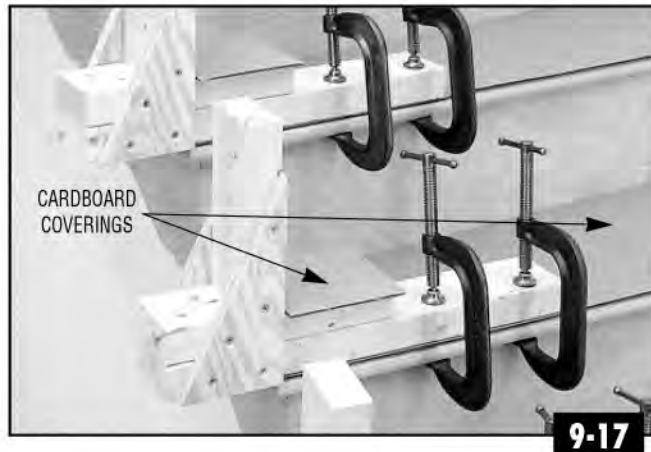

With all guides installed the form is now ready to accept the bending rail.

Next prepare the bending moulds for the bending rail. Care must be taken to ensure that the adhesive used will not bond the bending moulds permanently to the outside bending rail plies. Waxpaper can be used to line the inside of the mould or a torch gun can be used to melt ordinary paraffin wax into a solid covering. **PHOTO 9-18.**

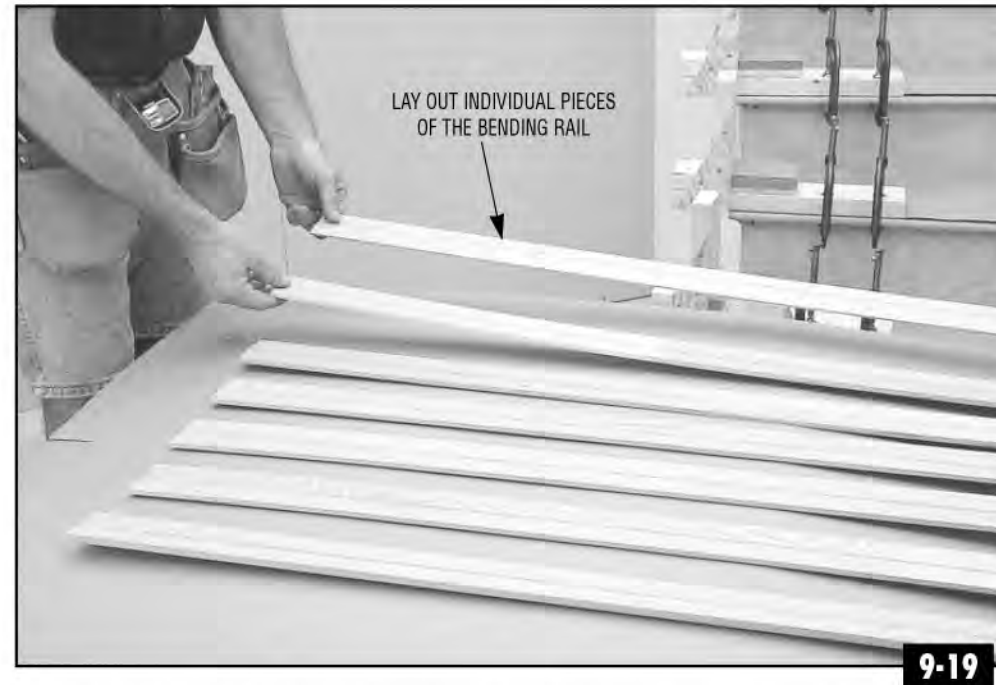

With the bending mould prepared, you can then address the preparation of the rail. While many good adhesive products are on the market today, it is important to choose one that is tailored to this type of application. An extended working time is critical to allow the time necessary to complete the bending process. These types of adhesives are offered from several reputable manufacturers in both resin powder products (*adhesives that are activated by water*) as well as one-part extended work time products.

Begin the preparation of the bending plies by laying the individual plies of the bending rail out on sawhorses. **PHOTO 9-19.**

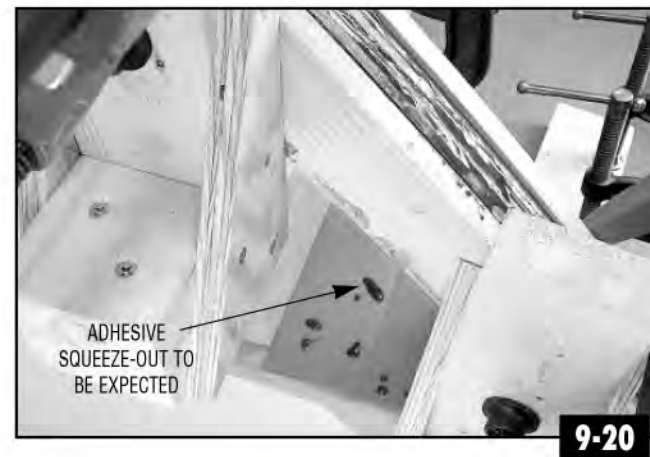

NOTE: To ensure against possible failures in the rail, it is very important that no dry pockets be left on any portion of the plies. Liberally coating both sides of the interior plies will protect against possible adhesive failures. Adhesive squeeze-out when the product is clamped to the guides (*See Photo 9-26*) is to be expected. **PHOTO 9-20.**

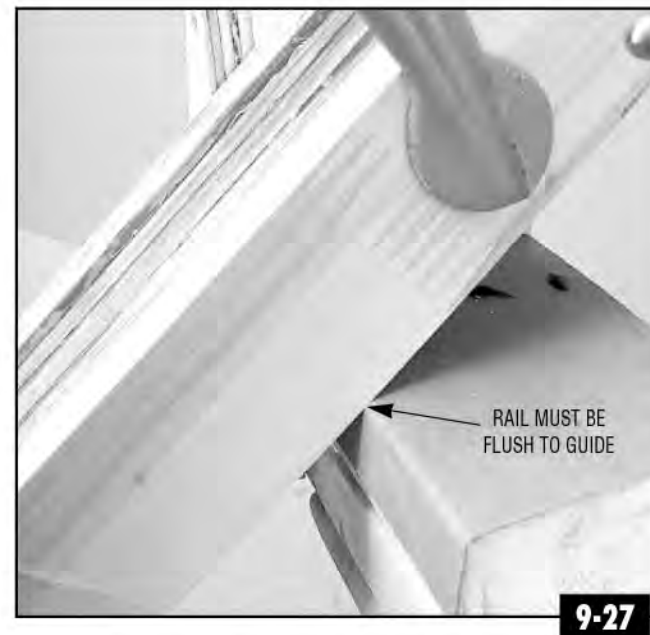
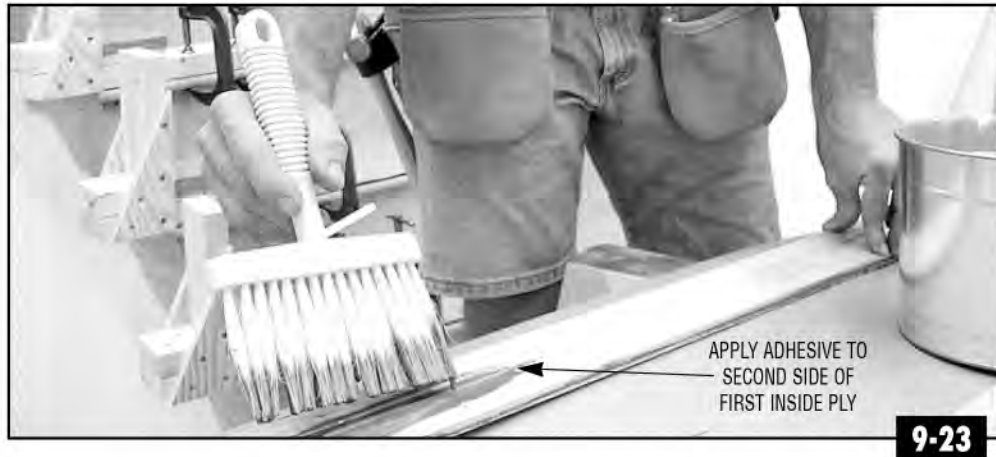
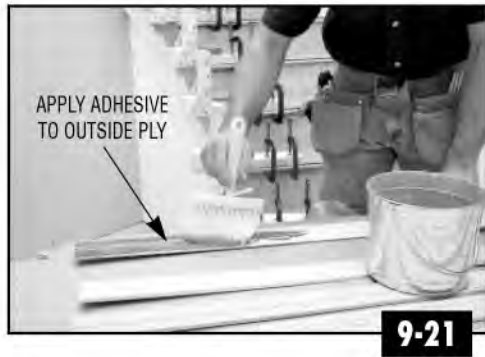

The next step in the process will be to clamp the bending rail/bending mould combination to the form created by the bending guides. With the rail pressed firmly into the corner of the guide, use a bar clamp (or equivalent) to securely attach the rail to the first guide at the bottom of the stair. The end of the bending rail should extend beyond the first and last bending guides to allow enough finished bent rail to be cut and fit to a newel or fitting. **PHOTO 9-26.**



Working up the stair, securely clamp the rail to each bending guide. **PHOTO 9-28.**

Begin by setting an outside piece of the bending rail finished side down and coating the exposed side. A brush or small roller will spread the adhesive evenly along the length of each ply of the bending rail. **PHOTO 9-21.** Next coat the outer side of the first interior ply and place coated side down onto the coated outside ply. **PHOTO 9-22.** Coat the exposed side of this first inside ply and continue through the plies until the second outside ply is set in place. **PHOTO 9-23.** With the rail together, wipe any excess glue from the outside plies and set the rail into the two pieces of bending mould. **PHOTO 9-24.** Tape the products together as tightly as possible at approximate 2' intervals along the length of the rail. Excess adhesive should then be removed from the top and bottom of the rail with a clean cloth or paper towels. **PHOTO 9-25.**

NOTE: The bottom of the bending rail should be flush with the horizontal portion of the bending guide before the clamp is permanently attached to the guide. **PHOTO 9-27.** Bending rail will begin to twist as it is applied to the stair and must be corrected before leaving the rail to set up in the form. A rail that is not parallel to the tread will be very difficult to install to the starting fitting and gooseneck fittings later in the installation process. See *Photo 9-10* for the optimum solution to rail twist.

C-clamps should then be applied directly to the bending mould in between each bending guide. On longer runs, more than one clamp between the guides will be required to apply the even pressure to the plies necessary for a successfully bent rail. **PHOTO 9-29.** The tightness of all clamps in the system should be rechecked at this time.



The final steps in the clamping process will be to continue the radius of the rail past the last bending guides, top and bottom, and to eliminate the twisting action of the rail to assure that the top and bottom of the rail are parallel to the floors. Bar clamps and bracing should be attached at the ends of the rail and shimmed or pulled into position as needed. **PHOTO 9-30.**

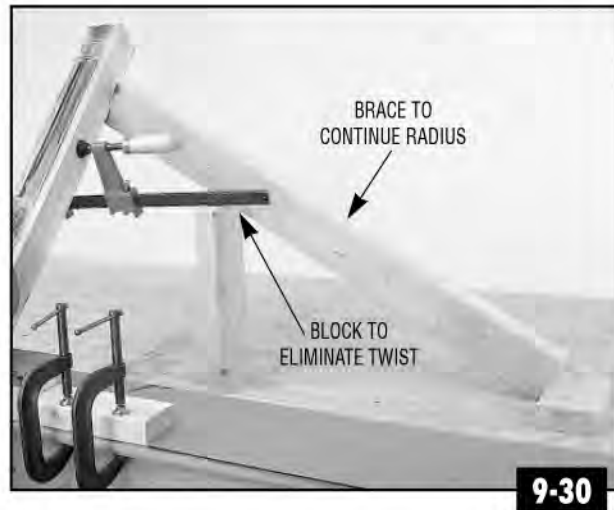

NOTE: Excess adhesive squeeze-out should be wiped off at this time. This will ease the finishing procedures detailed below.

After sufficient drying time, usually at least 24 hours, the rail can be removed from the clamps and bending mould. An extremely tight radius or high humidity conditions may require additional time to cure. Always refer to and follow adhesive manufacturer's instructions.



Sand the excess glue from the top and bottom of the rail, being careful not to distort the profile of the rail. Finish sand and apply standard finishing techniques. **PHOTO 9-31.**

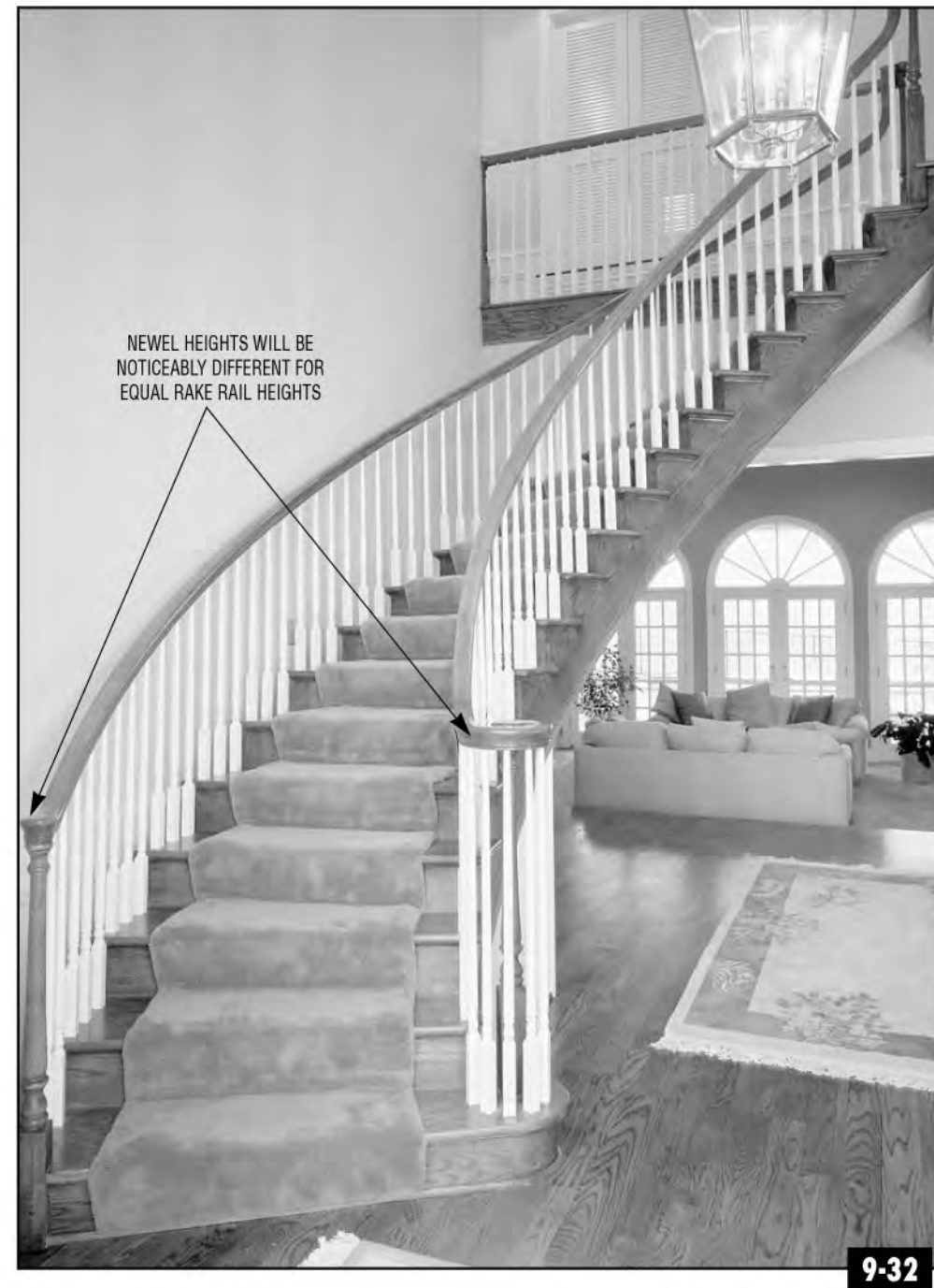

You can now apply standard installation techniques for both Post-to-Post and Over-the-Post applications.

NOTE: In double-open curved stairs, it should be noted that while standard installation techniques will apply, the length of the starting newels will be noticeably different in order to achieve equal rake rail heights on each side of the stair. **PHOTO 9-32.**

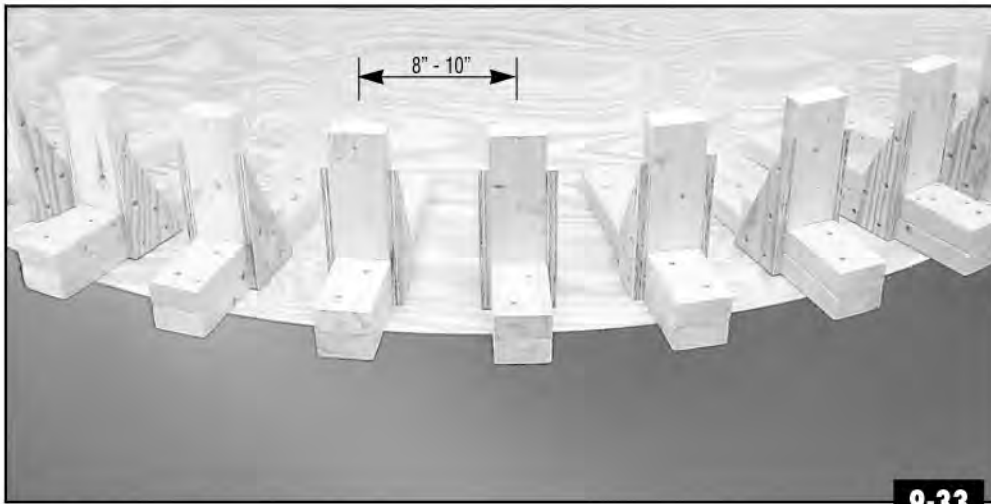

9-33

CURVED LEVEL RAIL

Preparation of level bending rail sections closely resembles the instructions for rake rail segments. The minimum bending radius will be greater for level sections (*See Chart 9-4*) and given the same parameters the expected spring-back will be more.

Bending guides should be set at no more than 8" - 10" apart along the balustrade center line of the curved level segment. **PHOTO 9-33.**

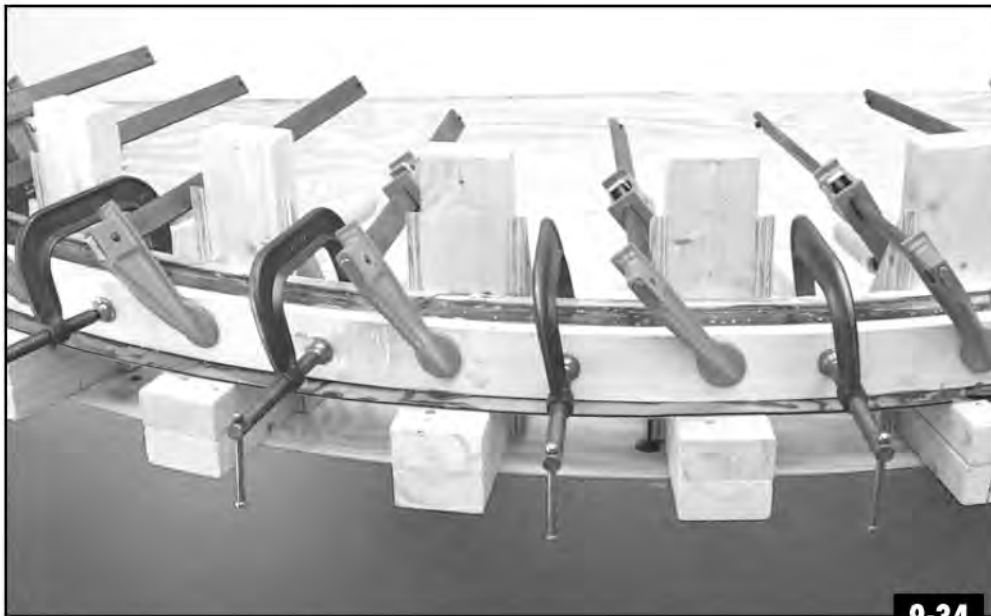

9-34

Being careful to make sure the rail is flush to both sides of the bending guide (*See Photo 9-27*), clamp the prepared bending rail to each bending guide with bar clamps. Next, place C-clamps between each guide and recheck the tightness of all clamps. **PHOTO 9-34.** After the required drying time, remove the rail and finish sand. Standard installation techniques can then be applied.



WM Coffman®

FORGED

CHAPTER 11

Forged

The installation of Coffman's forged balusters is very similar to the time-honored techniques of "standard" hardwood stair systems. The tools and installation techniques listed in this chapter will help you to easily create the stylish look that Coffman's Forged Balustrade Collection provides today's contemporary home.



11-1

The Coffman Forged Balustrade Program combines one of the broadest selections in the industry with epoxy adhesives, application tools, and finish accessories. This system provides for professional installations that are attractive, simple to install, and permanently secure. **PHOTO 11-2.**



BASE COLLAR
(C-2340F Shown)

ADJUSTABLE COLLAR
(C-2345F Shown)

RAKE COLLAR
(C-2350F Shown)

Begin the installation by temporarily attaching the handrail to the newels throughout the stair and balcony, and marking the treads and underside of the rail for baluster placement. The tread run and the profiles of forged balusters chosen will determine layout of the balusters on the treads. See *Chapter 5* for more information on balustrade layout.

At each baluster location, drill an 11/16" (3/4" for C-257? Royal series) diameter hole 1" deep into the treads and landing tread and a 1/2" diameter hole approximately 1-1/2" deep in the underside of the rail. Refer to *Chapter 8, Page 4* for more information on drilling techniques for proper rail preparation. **PHOTO 11-3.**

With all baluster holes drilled and the rail temporarily set back in place, use a carpenter's rule to measure the exact distance from the tread to the lower side of the drilled 1/2" diameter hole in the rail. **PHOTO 11-4.**

After adding 1" for insertion into the rail and 1" for insertion into the tread, use a miter saw equipped with a standard 1/8" flexible cut-off blade to trim the bottom of the baluster to the exact length. **PHOTO 11-5.**



11-2



11-3

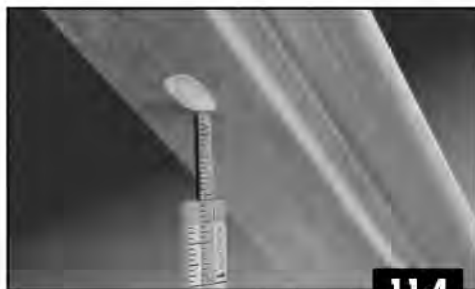

11-4



11-5



11-6



11-7



11-8



11-9



11-10

When all balusters are trimmed and ready for installation, deposit C-2301 Epoxy Adhesive into each baluster hole in the treads and landing tread and the rail. **PHOTO 11-6.**

NOTE: Work time for C-2301 is approximately 20 minutes.

Making sure that the corresponding base collar is placed on the bottom of the baluster, set each baluster into the tread hole. **PHOTO 11-7.**

Working one baluster in at a time, place the rail system on top of the balusters and install the rail permanently to the newels. Each baluster should then be rotated one turn to assure even coverage of the epoxy. See *Chapter 8, Pages 8-10* for more information on the capping of the rail onto the balusters. **PHOTO 11-8.**

A combination square should then be used to square each baluster on the tread. **PHOTO 11-9.**

Finish the installation by using epoxy to fill any void around the base of the baluster and to secure the base collar. **PHOTO 11-10.**

Continue through stair segments until the entire stair is installed. Allow time for curing based on adhesive manufacturer's recommendations.

SPECIALTY ACCESSORIES

ADJUSTABLE COLLAR

The C-2345 Adjustable Collar, when used with the C-2555 Straight Forged Baluster, can be used to design a distinctive pattern within any forged system. Place the required number of adjustable collars on each C-2555 straight baluster before installing. **PHOTO 11-11.**

After the balusters are installed, use an allen wrench to tighten the collar's set screw, permanently attaching the collar at the desired location. **PHOTO 11-12.**

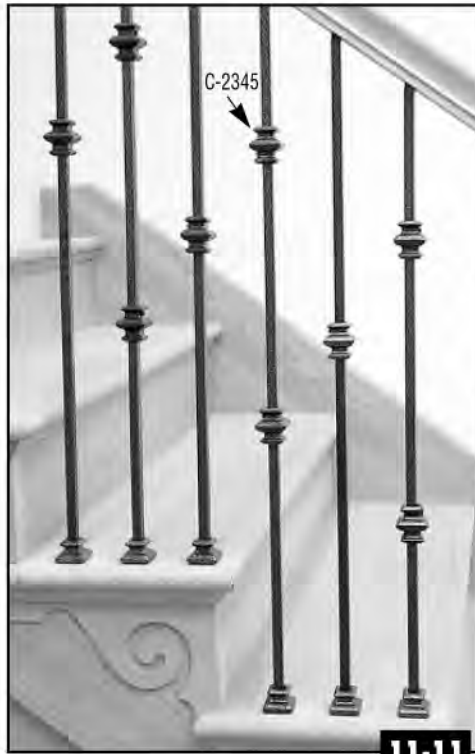

11-11

RAKE COLLAR

The C-2350 Rake Collar replaces the base collar on knee wall stairs. Place a collar onto the bottom of all balusters before installing. With the collar resting firmly on the knee wall, permanently attach the rake collars by tightening the provided set screw.

PHOTO 11-13.

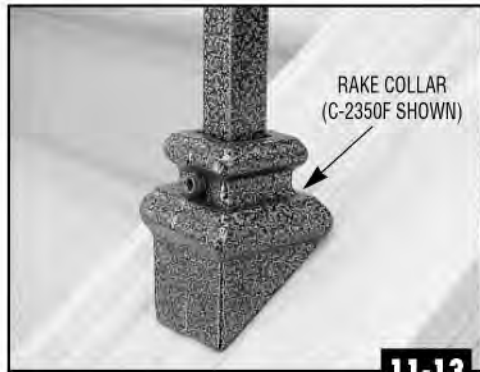

11-13

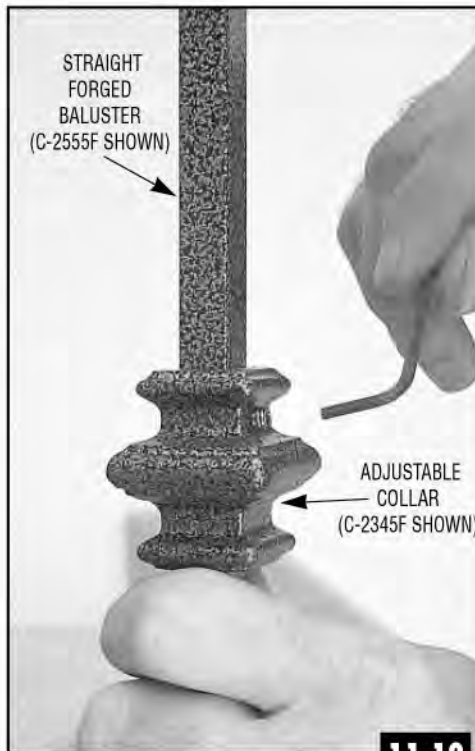

11-12

WM Coffman®

HARDWARE

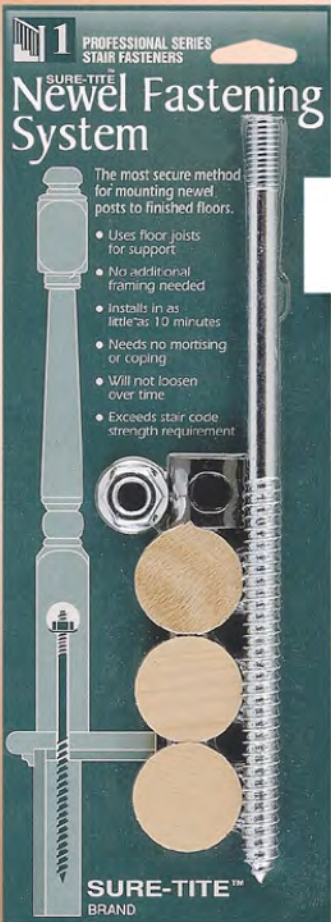

12

C-3008 SURE-TITE™ NEWEL FASTENING SYSTEM

Tools Required - Drill bits: 3/8", 5/8", 1-1/2". 3/4" Box-end wrench

Step 1. Cut post to length. Locate center of post on floor, and predrill all holes (Fig. A). Important: When drilling post, drill 1-1/2" hole first. Lag must be installed into solid blocking.

Step 2. Screw lag into floor and bend top plumb. Two nuts may be used to create a temporary bolt head (Fig. B).

Step 3. Place post over lag. From 1-1/2" access hole, insert curved washer and nut. Torque down hard, using a 3/4" box-end wrench. Plumb post if necessary by cutting bottom at a slight angle and reapplying. Stress post in all directions and retighten with torque. Glue hole, tap in plug, and sand flat (Fig. C).

Contents: 1 lag bolt 10-3/4" long, 1 washer, 1 nut, 3 plugs

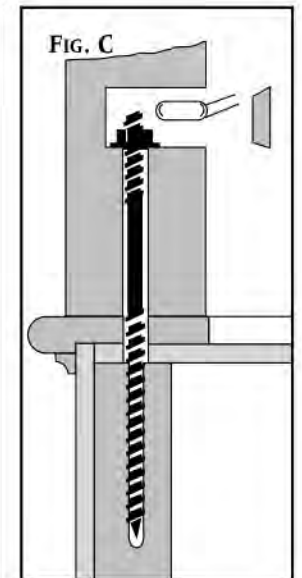
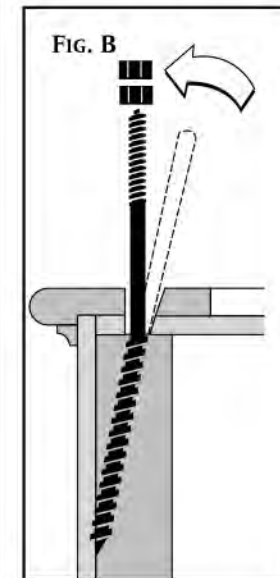
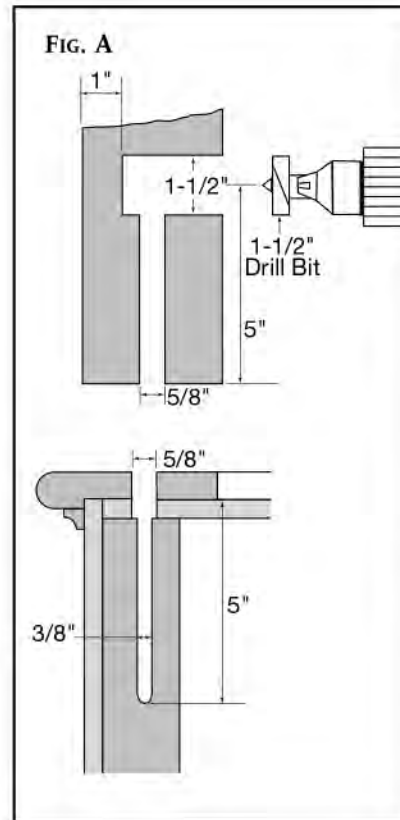



**C-3201
BALUSTER FASTENING KIT/DRIVER**

Tools Required - Drill bits: 9/32". Reversible drill

Step 1. Trim baluster to length and predrill a 9/32" x 1-1/4" hole in bottom.

Step 2. Secure driver into a reversible drill. Drive fasteners 1-1/4" into each baluster.

Step 3. Predrill tread or floor with 9/32" bit and install baluster by gripping at bottom and twisting into place.

Contents: 1 driver, 4 baluster fasteners 2-1/2" long. Fasteners also sold separately.

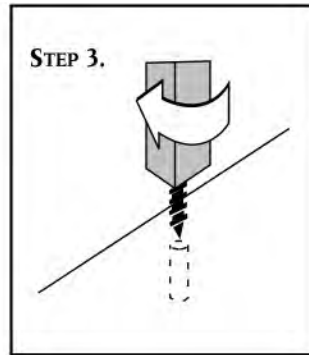
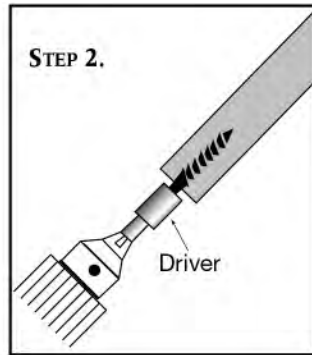
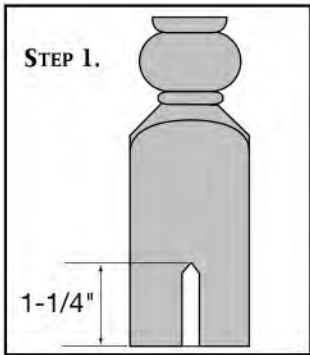

**C-3301
RAIL & POST FASTENER**

Tools Required - Socket wrench, Drill Bits: 1/4", 7/16", 1"

Step 1. Predrill parts as shown.

Step 2. Secure bolt, using socket wrench.

Step 3. Glue hole, tap in plug, and sand flat.

Contents: 1 lag bolt 3" long, 1 washer, 2 plugs

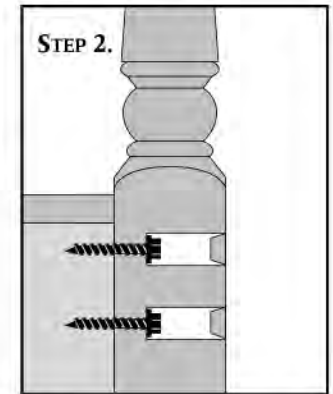
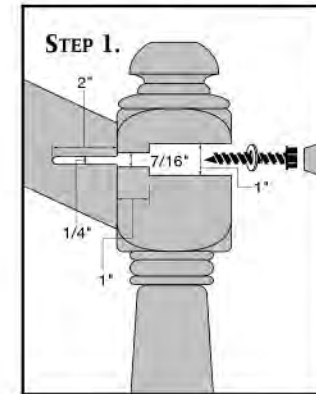

**C-3302
RAIL-BOLT FASTENER
(carded)**

**C-3001 RAIL BOLT
(uncarded)**

Tools Required - Drill bits: 1/4", 3/8", 1". 1/2" Box-end wrench

Step 1. After trimming rail to length, drill all holes. Begin with 1" hole in rail (Fig. A or B).

Step 2. Using a C-3901 Rail-Bolt Wrench or Vise Grips, mount bolt into 1/4" hole.

Step 3. Apply glue and join parts. From 1" access hole, insert curved washer and nut. Torque down, using box-end wrench. Glue hole, tap in plug, and sand flat (Fig. C).

Contents: 1 fastener 3-1/2" long, 1 washer, 1 nut, 2 plugs (No plugs in C-3001)

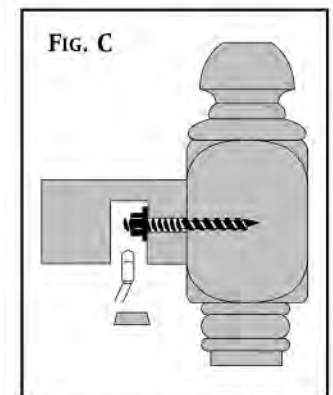
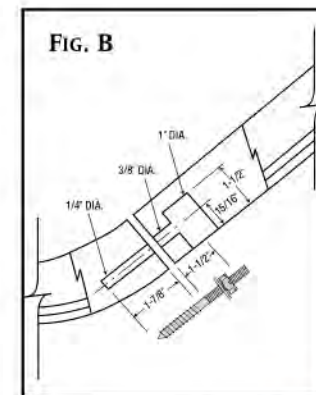
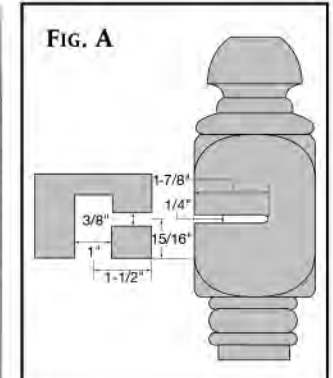

**C-3505
L-BRACKET POST FASTENER**



The Coffman C-3505 L-Bracket Post Fastener consists of four metal brackets, wood screws, and mitered wood trim pieces.

Step 1. Align the brackets flush with the bottom of the newel and screw into the face of the newel.

Step 2. Place newel into correct position and install screws at an angle into the mounting surface.

Step 3. Finish by gluing and nailing the premitered trim pieces around the brackets.

See Page 28 in the WM Coffman 2016 Buyer's Guide for all available HR Brackets

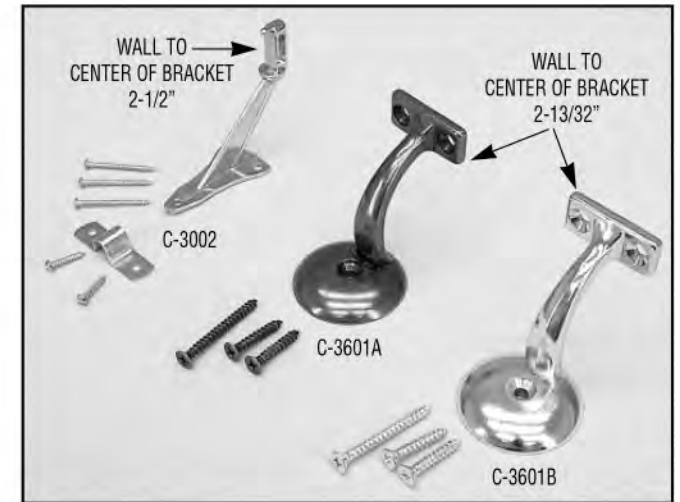

See Chapter 7, Pages 27-28 for full installation instructions.

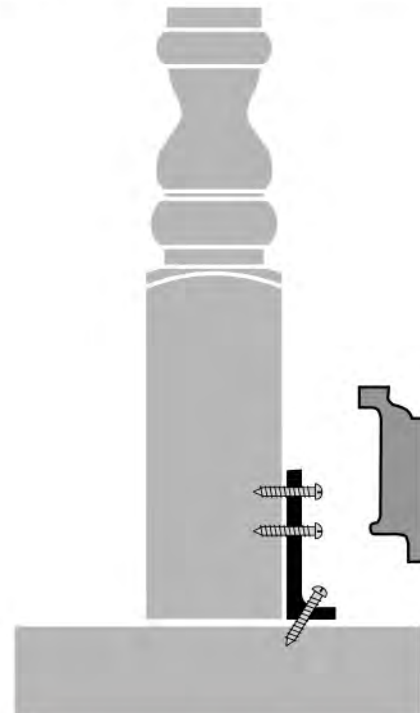
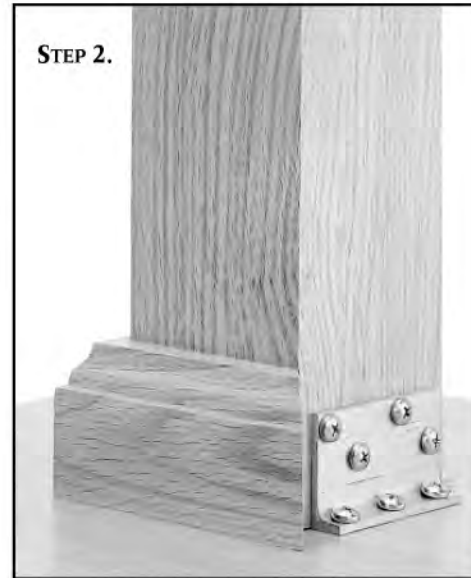
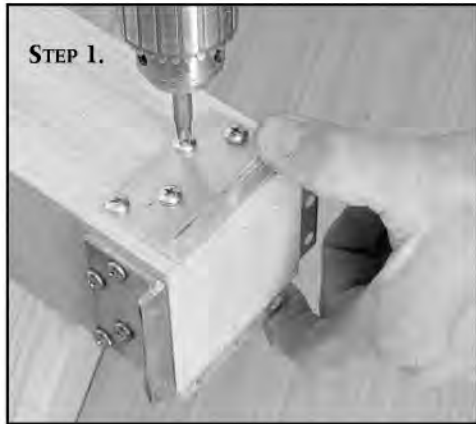

**C-3901
RAIL-BOLT WRENCH**

Step 1. Once all the holes have been drilled, use the Coffman C-3901 Rail-Bolt Wrench to insert the rail bolt 2" into the 1/4" diameter hole in the rail, post, or fitting (Fig. A).

Step 2. Glue rail and fitting. With the washer on the rail bolt, place the nut on the magnetic pin and apply rubber band (Fig. B).

Step 3. Press firmly against the end of the rail bolt and pull down on the rubber band to start the nut (Fig. C).

Step 4. The 1/2" boxed-end of the wrench can then be used to securely tighten the nut.



13

CONVERSION CHART, FRACTIONS OF INCHES TO DECIMALS

FRACTION	DECIMAL	FRACTION	DECIMAL
1/64	.0156	33/64	.5156
1/32	.0313	17/32	.5313
3/64	.0469	35/64	.5469
1/16	.0625	9/16	.5625
5/64	.0781	37/64	.5781
3/32	.0938	19/32	.5938
7/64	.1094	39/64	.6094
1/8	.1250	5/8	.6250
9/64	.1406	41/64	.6406
5/32	.1563	21/32	.6563
11/64	.1719	43/64	.6719
3/16	.1875	11/16	.6875
13/64	.2031	45/64	.7031
7/32	.2188	23/32	.7188
15/64	.2344	47/64	.7344
1/4	.2500	3/4	.7500
17/64	.2656	49/64	.7656
9/32	.2813	25/32	.7813
19/64	.2969	51/64	.7969
5/16	.3125	13/16	.8125
21/64	.3281	53/64	.8281
11/32	.3438	27/32	.8438
23/64	.3594	55/64	.8594
3/8	.3750	7/8	.8750
25/64	.3906	57/64	.8906
13/32	.4063	29/32	.9063
27/64	.4219	59/64	.9219
7/16	.4375	15/16	.9375
29/64	.4531	61/64	.9531
15/32	.4688	31/32	.9688
31/64	.4844	63/64	.9844
1/2	.5000	1	1.0000

ANATOMY OF A STAIR

13-2

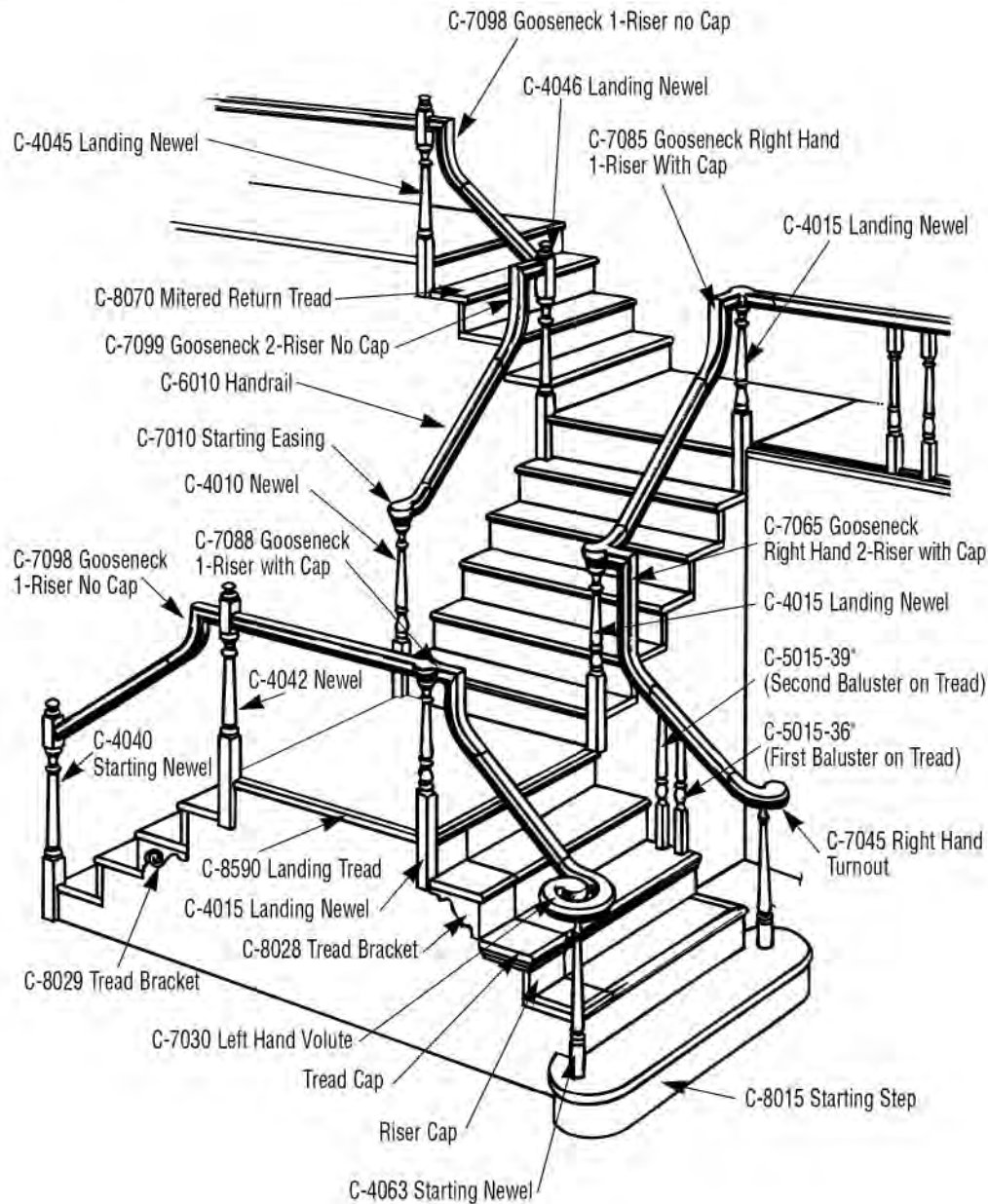

ANATOMY OF A STAIR

13-2

Coffman Traditional parts are shown for a 34" rake rail height. For Hampton, Classic, Marion, Bristol and Art Deco part numbers, consult Coffman's Buyers Guide.

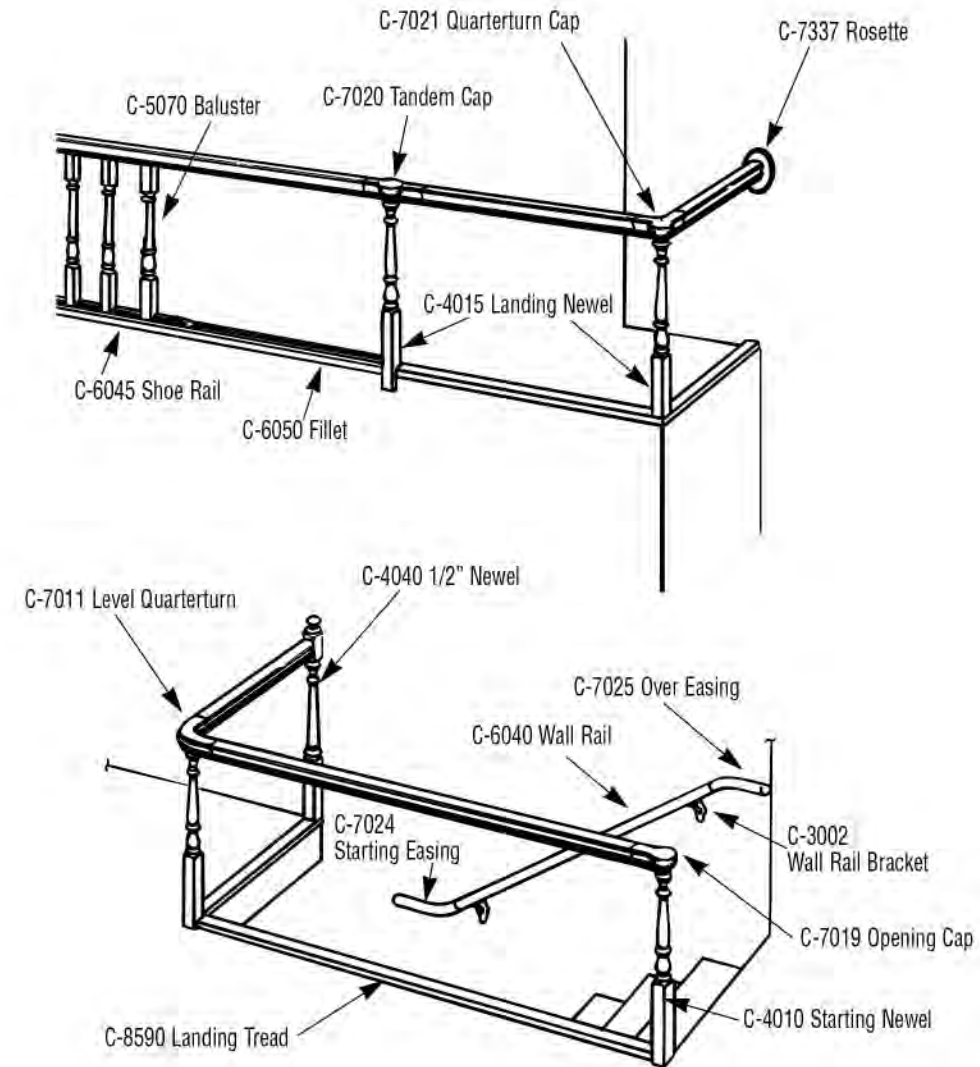

RISE-RUN ANGLE CHART

R U N

RISE

	9"	1/8	1/4	3/8	1/2	5/8	3/4	7/8	10"	1/8	1/4	3/8	1/2	5/8	3/4	7/8	11"	1/8	1/4	3/8	1/2	5/8	3/4	7/8	12"	
6"	33.7 56.3	33.3 56.7	33.0 57.0	32.6 57.4	32.3 57.7	31.9 58.1	31.6 58.3	31.3 58.7	31.0 59.0	30.7 59.3	30.3 59.7	30.0 60.0	29.7 60.3	29.5 60.5	29.2 60.8	28.9 61.1	28.6 61.4	28.3 61.7	28.1 61.9	27.8 62.2	27.6 62.4	27.3 62.7	27.1 62.9	26.8 63.2	26.6 63.4	
1/8	34.2 55.8	33.9 56.1	33.5 56.5	33.2 56.8	32.8 57.2	32.5 57.5	32.1 57.9	31.8 58.2	31.5 58.5	31.2 58.8	30.9 59.1	30.6 59.4	30.3 59.7	30.0 60.0	29.7 60.3	29.4 60.6	29.1 60.7	28.8 61.2	28.6 61.4	28.3 61.7	28.0 62.0	27.8 62.2	27.5 62.5	27.3 62.7	27.0 63.0	
1/4	34.8 55.2	34.4 55.6	34.0 56.0	33.7 56.3	33.3 56.7	33.0 57.0	32.7 57.3	32.3 57.7	32.0 58.0	31.7 58.3	31.4 58.6	31.1 58.9	30.8 59.2	30.5 59.5	30.2 59.8	29.9 60.1	29.6 60.4	29.3 60.7	29.1 60.9	28.8 61.2	28.5 61.5	28.3 61.7	28.0 62.0	27.8 62.2	27.5 62.5	
3/8	35.3 54.7	34.9 55.1	34.6 55.4	34.2 55.8	33.9 56.1	33.5 56.5	33.2 56.8	32.8 57.2	32.5 57.5	32.2 57.8	31.9 58.1	31.6 58.4	31.3 58.7	31.0 59.0	30.7 59.3	30.4 59.6	30.1 59.9	29.8 60.2	29.5 60.5	29.3 60.7	29.0 61.0	28.7 61.3	28.5 61.5	28.2 61.8	28.0 62.0	
1/2	35.8 54.2	35.4 54.6	35.1 54.9	34.7 55.3	34.4 55.6	34.0 56.0	33.7 56.3	33.3 56.7	33.0 57.0	32.7 57.3	32.4 57.6	32.1 57.9	31.8 58.2	31.5 58.5	31.2 58.8	30.9 59.1	30.6 59.4	30.3 59.7	30.0 60.0	29.7 60.3	29.5 60.5	29.2 60.8	29.0 61.0	28.7 61.3	28.4 61.6	
5/8	36.4 53.6	36.0 54.0	35.6 54.4	35.2 54.8	34.9 55.1	34.5 55.5	34.2 55.8	33.9 56.1	33.5 56.5	33.2 56.8	32.9 57.1	32.6 57.4	32.3 57.7	31.9 58.1	31.6 58.4	31.3 58.7	31.1 58.9	30.8 59.2	30.5 59.5	30.2 59.8	30.0 60.0	29.7 60.3	29.4 60.6	29.2 60.8	28.9 61.1	
3/4	36.9 53.1	36.5 53.5	36.1 53.9	35.8 54.2	35.4 54.6	35.0 55.0	34.7 55.3	34.3 55.7	34.0 56.0	33.7 56.3	33.4 56.6	33.0 57.0	32.7 57.3	32.4 57.6	32.1 57.9	31.8 58.2	31.5 58.5	31.2 58.8	31.0 59.0	30.7 59.3	30.4 59.6	30.1 59.9	29.9 60.1	29.6 60.4	29.4 60.6	
7/8	37.4 52.6	37.0 53.0	36.6 53.4	36.3 53.7	35.9 54.1	35.5 54.5	35.2 54.8	34.8 55.2	34.5 55.5	34.2 55.8	33.9 56.1	33.5 56.5	33.2 56.8	32.9 57.1	32.6 57.4	32.3 57.7	32.0 58.0	31.7 58.3	31.4 58.6	31.1 58.9	30.9 59.1	30.6 59.4	30.3 59.7	30.1 59.9	29.8 60.2	
7"	37.9 52.1	37.5 52.5	37.1 52.9	36.7 53.3	36.4 53.6	36.0 54.0	35.7 54.3	35.3 54.7	35.0 55.0	34.7 55.3	34.3 55.7	34.0 56.0	33.7 56.3	33.4 56.6	33.1 56.9	32.8 57.2	32.5 57.5	32.2 57.8	31.9 58.1	31.6 58.4	31.3 58.7	31.1 58.9	30.8 59.1	30.5 59.5	30.3 59.7	
1/8	38.4 51.6	38.0 52.0	37.6 52.4	37.2 52.8	36.9 53.1	36.5 53.5	36.2 53.8	35.8 54.2	35.5 54.5	35.1 54.9	34.8 55.2	34.6 55.5	34.2 55.8	33.8 56.2	33.5 56.5	33.2 56.8	32.9 57.1	32.6 57.4	32.3 57.7	32.1 57.9	31.8 58.2	31.5 58.5	31.2 58.8	31.0 59.0	30.7 59.3	30.7 59.3
1/4	38.9 51.1	38.5 51.5	38.1 51.9	37.7 52.3	37.3 52.7	37.0 53.0	36.6 53.4	36.3 53.7	35.9 54.1	35.6 54.4	35.3 54.7	34.9 55.1	34.6 55.4	34.3 55.7	34.0 56.0	33.7 56.3	33.4 56.6	33.1 56.9	32.8 57.2	32.5 57.5	32.2 57.8	32.0 58.0	31.7 58.3	31.4 58.6	31.1 58.9	
3/8	39.3 50.7	39.0 51.0	38.6 51.4	38.2 51.8	37.8 52.2	37.5 52.5	37.1 52.9	36.8 53.2	36.4 53.6	36.1 53.9	35.7 54.3	35.4 54.6	35.1 54.9	34.8 55.2	34.5 55.5	34.1 55.9	33.8 56.2	33.5 56.5	33.2 56.8	33.0 57.0	32.7 57.3	32.4 57.6	32.1 57.9	31.8 58.2	31.6 58.4	
1/2	39.8 50.2	39.4 50.6	39.0 51.0	38.7 51.3	38.3 51.7	37.9 52.1	37.6 52.4	37.2 52.8	36.9 53.1	36.5 53.5	36.2 53.8	35.9 54.1	35.5 54.5	35.2 54.8	34.9 55.1	34.6 55.4	34.3 55.7	34.0 56.0	33.7 56.3	33.4 56.6	33.1 56.9	32.8 57.2	32.6 57.4	32.3 57.7	32.0 58.0	
5/8	40.3 49.7	39.9 50.1	39.5 50.4	39.1 50.9	38.8 51.2	38.4 51.6	38.0 52.0	37.7 52.3	37.3 52.7	37.0 53.0	36.6 53.4	36.3 53.7	36.0 54.0	35.7 54.3	35.3 54.7	35.0 55.0	34.7 55.3	34.4 55.6	34.1 55.9	33.8 56.2	33.5 56.5	33.3 56.7	33.0 57.0	32.7 57.3	32.4 57.6	
3/4	40.7 49.3	40.3 49.7	40.0 50.0	39.6 50.4	39.2 50.8	38.8 51.2	38.5 51.5	38.1 51.9	37.8 52.2	37.4 52.6	37.1 52.9	36.8 53.2	36.4 53.6	36.1 53.9	35.8 54.2	35.5 54.5	35.2 54.8	34.9 55.1	34.6 55.4	34.3 55.7	34.0 56.0	33.7 56.3	33.4 56.6	33.1 56.9	32.9 57.1	
7/8	41.2 48.8	40.8 49.2	40.4 49.6	40.0 50.0	39.7 50.3	39.3 50.7	38.9 51.1	38.6 51.4	38.2 51.8	37.9 52.1	37.5 52.5	37.2 52.8	36.9 53.1	36.5 53.5	36.2 53.8	35.9 54.1	35.6 54.4	35.3 54.7	35.0 55.0	34.7 55.3	34.4 55.6	34.1 55.9	33.8 56.2	33.6 56.4	33.3 56.7	
8"	41.6 48.4	41.2 48.8	40.9 49.1	40.5 49.5	40.1 49.9	39.7 50.3	39.4 50.6	39.0 51.0	38.7 51.3	38.3 51.7	38.0 52.0	37.6 52.4	37.3 52.7	37.0 53.0	36.7 53.3	36.3 53.7	36.0 54.0	35.7 54.3	35.4 54.6	35.1 54.9	34.8 55.2	34.5 55.5	34.2 55.8	34.0 56.0	33.7 56.3	
1/8	42.1 47.9	41.7 48.3	41.3 48.7	40.9 49.1	40.5 49.5	40.2 49.8	39.8 50.2	39.4 50.6	39.1 50.9	38.7 51.3	38.4 51.6	38.1 51.9	37.7 52.3	37.4 52.6	37.1 52.9	36.8 53.2	36.5 53.5	36.1 53.9	35.8 54.2	35.5 54.5	35.2 54.8	35.0 55.0	34.7 55.3	34.4 55.6	34.1 55.9	
1/4	42.5 47.5	42.1 47.9	41.7 48.3	41.3 48.7	41.0 49.0	40.6 49.4	40.2 49.8	39.9 50.1	39.5 50.5	39.2 50.8	38.8 51.2	38.5 51.5	38.2 51.8	37.8 52.2	37.5 52.5	37.2 52.8	36.9 53.1	36.6 53.4	36.3 53.7	36.0 54.0	35.7 54.3	35.4 54.6	35.1 54.9	34.8 55.2	34.5 55.5	
3/8	42.9 47.1	42.5 47.5	42.2 47.8	41.8 48.2	41.4 48.6	41.0 49.0	40.7 49.3	40.3 49.7	39.9 50.1	39.6 50.4	39.3 50.7	38.9 51.1	38.6 51.4	38.2 51.8	37.9 52.1	37.6 52.4	37.3 52.7	37.0 53.0	36.7 53.3	36.4 53.6	36.1 53.9	35.8 54.2	35.5 54.5	35.2 54.8	34.9 55.1	
1/2	43.4 46.6	43.0 47.0	42.6 47.4	42.2 47.8	41.8 48.2	41.4 48.6	41.1 48.9	40.7 49.3	40.4 49.6	40.0 50.0	39.7 50.3	39.3 50.7	39.0 51.0	38.7 51.3	38.3 51.7	38.0 52.0	37.7 52.3	37.4 52.6	37.1 52.9	36.8 53.2	36.5 53.5	36.2 53.8	35.9 54.1	35.6 54.4	35.3 54.7	

Top Number = Angle of Stair.
Bottom Number = 90° Minus Angle of Stair.

13-3



WM Coffman®

GLOSSARY/INDEX

CHAPTER 14

Glossary/Index

14

Glossary

Adjustable Collar – A decorative forged collar attachable anywhere along the length of the plain forged baluster to create unique balustrade designs.

Adjustable Newel – A doweled starting newel that can be trimmed in length by the installer. The newel is drilled to accept a dowel on the bottom. The dowel is shipped loose and installed after the newel is trimmed.

Angle Button – See *Angle Gauge*.

Angle Gauge – A locking devise that can be attached to a framing square to give you consistent angles during layout.

Angle Newel – The longest of all newels, used at landings where there is a change in the direction of the stair and railing. Angle newels may be two, three or four rises high.

Angle Stair – A stair with one or more turns. Examples are L-Shaped stairs and U-Shaped stairs.

Apron – See *Bandboard*.

Ascending Volute – A volute that begins its ascent sooner than a standard volute, allowing for the use of a shorter newel and shorter balusters on the starting step.

Balcony Balustrade – A level portion of balustrade with components that match the stairway.

Balcony Height – The vertical distance from the finish-floor to the top of the level railing.

Baluster – A decorative vertical member, used to fill the open area between the railing and the floor or tread, adding safety, support and stability to the balustrade.

Baluster Fastening Kit – A kit which includes a driver and baluster fasteners for use in installing balusters to treads or floor. Coffman item #C-3201.

Balustrade – A rail system which includes handrail, newels and balusters.

Balustrade Center Line – An imaginary line which represents the center of the handrail, balusters, and newels.

Bandboard – A decorative trim board to finish around well holes and balconies.

Base Collar – A forged trim collar used at the base of forged balusters.

Bending Guides – L-shaped brackets that when used together, create a form to clamp the bending rail to while waiting for the glued rail to cure to the necessary radius. Bending guides may be purchased, or made from materials on the job site.

Bending Mould – A form, moulded to the outside profile of the rail, that is used to cradle bending rail as it is being bent to the shape of the stair or balcony.

Bending Rail – A rail profile made up of thin vertical strips, or plys, which have been moulded with a tongue and groove bead to create an alignment of the plys. Bending rail offers the ability to glue and bend handrail to a radius to match most curved balustrades.

Bent Riser – The riser included in a starting step, curved on one or both ends to form a decorative first step in a stair.

Blocking – Solid wood pieces installed during framing to aid in the secure installation of handrail brackets, rosettes, half newels, etc.

Box Newel – A large square newel, usually hollow, used in a Post-to-Post balustrade system.

Box Stair – A stair where the carriages/skirtboards house the treads and risers forming a box-like unit. Box stairs are typically pre-assembled and delivered to the job site as one "boxed" unit.

Bracket – See *Tread Bracket*.

Cap – That part of a fitting which widens in order to sit on top of a pin top newel. Caps are found in a variety of different Over-the-Post fittings.

Carriage – A supporting member running the length of the stairway on which treads, risers, and balustrade are mounted. Also called Rough Stringers or Rough Horses.

Center Line – See *Balustrade Center Line*.

Circular Stair – See *Spiral Stair*.

Clamp Nail – A steel spline that is used to join the components that make up fittings. Clamp nails can also be used to attach fittings to handrail.

Closed Side Skirtboard – The trim board that is installed against the wall as a decorative accent and scuff barrier between the stair and finished wall.

Continuous Rail – See *Over-the-Post*.

Coped End – A rail fitting that has the profile of the rail shaped, or coped, into one end of a straight piece of rail.

Cove Moulding – A concave shaped moulding used to cover the joint formed where the face of the riser meets the underside of the tread. On an open stair the cove moulding is continued under the return nosing.

Curb Wall – See *Knee Wall*.

Curved Stair – A stair that winds or curves its way from one floor to the next. It may be constructed having one turn of direction, or a series of turns.

Double Carriage – Two carriages that are attached together to meet a specific structural requirement.

Double Mitered Return Tread – A tread that has mitered return nosing applied to both ends, used in a double open balustrade stair.

Dropping the Carriage – To trim the bottom of the first rise of a rough carriage by the difference in thickness between the tread and the first floor finish material. This assures that each rise going up the stair remains the same after finish materials are installed.

Easing – See *Over Easing* or *Up Easing*.

Epoxy – Type of adhesive recommended to install forged balusters and collars.

False Riser – See *Riser Cap*.

False Starting Step – See *Starting End Cap*.

False Tread – See *Tread Cap*.

Fillet – A thin moulding that is fitted into plowed handrail and shoe rail between the balusters.

Finish-Floor to Finish-Floor – The vertical measurement taken from the top of the finished floor of the lower level to the top of the finished floor of the upper level. The total rise of a stair.

Fitting – A combination of components that are profiled to match handrail patterns and permit directional and vertical changes with handrail in Over-the-Post balustrades.

Forged Collection – Coffman's system of metal balusters and accessories.

Guardrail – See *Balcony*.

Glue Block – A structural wood block, square or triangular, glued to the underside of a step.

Gooseneck – A rail fitting used to accommodate transitions in height and/or direction at intermediate and balcony landings.

Half Newel – A newel cut directly through the center lengthwise, to be used where handrail terminates at a wall.

Handrail – See *Rail*.

Hanger Board – A board, usually plywood, used as a method of attaching carriages to the upper floor header.

Headroom – The vertical distance from the slope of the stair along the nosing to the ceiling above.

Header – A floor framing member that runs across the well opening. The top riser of the stair is attached to the header.

Housed Stringer – See *Routed Stringer*.

Intermediate Newel – A newel installed at the turn of an angle stair.

Kick Board – A board that is secured to the floor under the bottom front edges of the carriages.

Knee Wall – A short, capped wall creating a closed tread system.

L-Bracket Post Fastener – A kit which includes metal brackets, wood screws and mitered wood trim pieces, used to attach square-based newels to the floor or tread. Coffman item #C-3505.

L-Shaped Stair – A stair with an intermediate landing to change the direction.

Landing – A platform separating two flights of stairs.

Landing Newel – A newel used at the top of a sloped stair section.

Landing Tread – A structural moulding, used on all landings and balconies, to create a transition between the stair and the finished floor.

Ledger Board – A board attached to the header on which upper ends of carriages can rest.

Left Hand Stair – A stair with balustrade on the left side from the bottom of the stair looking up.

Left Hand Tread – A mitered return tread with return nosing applied to the left side from the bottom of the stair looking up.

Level Quarterturn – A rail fitting that permits level handrail to turn 90 degrees.

Level Rail – Railing used on a balcony or a landing.

Line of Travel – The line along which most people walk as they proceed up a stair. Its location is critical to tread depth in winding and/or circular stairs.

Material List – See *Take-Off*.

Miter Jig – A tool designed by Coffman which eliminates the need for a pitch block in determining where to cut easings on fittings, while cradling the fitting for a plumb, square cut. Coffman item #C-3099.

Mitered Return Tread – A tread which has a piece of return nosing applied to either the left or right side for use in an open stair.

Mitered Return Tread Cap – A tread cap that has return nosing on one side for use in an open stair.

Mitered Riser – A riser with a mitered edge for attaching to the skirtboard or decorative bracket.

Mitered Skirtboard – A skirtboard with mitered edges where the risers will be attached.

Moulding – A term describing lineal profiled components.

Nailing Jig – See *Tread Nailing Jig*.

Newel – A structural, vertical post used at the top and bottom of every stair, at all directional changes, and at intervals of not more than 8' on level balcony runs.

Newel Cap – See *Cap*.

Nosing – The rounded edge of a tread.

Notched Newel – Refers to newels that have the bottom block cut out to allow for correct center line placement.

OTP – The abbreviation for Over-the-Post.

Open Side Skirtboard – The trim board that is installed on the open side of the stair as a decorative accent.

Open Stair – A stair where the treads and risers are exposed from one or both sides.

Opening Cap – A rail fitting used where level rail starts on top of an Over-the-Post newel.

Orientation – Handing, left hand or right hand, determined from the bottom of the stair looking up.

Over Easing – A rail fitting used to transition from sloped rail to level rail without the use of a gooseneck.

Over-the-Post – A balustrade system which utilizes fittings to go over newels for an unbroken, continuous handrail.

Partial Open Stair – A stair that has an open balustrade that extends only a portion of the way up the stair before running into a structural wall.

Partial Wall – A wall that will enclose the upper portion of the stair.

PICKET – See *Baluster*.

Pin Top Baluster – A baluster with a round top that is installed by drilling holes into the bottom of the rail.

Pin Top Newel – An Over-the-Post newel that has a pin turned on the top to fit into the cap of a fitting.

Pitch – See *Rake*.

Pitch Block – A block of wood that is cut to form a right triangle using the rise and run dimensions of the stair.

Plain Tread – A tread that is square on both sides and nosed on the front.

Plain Tread Cap – A tread cap that is square on both sides, nosed on the front, and used on the closed side of a stair.

Platform – See *Landing*.

Plow – A recess moulded in the bottom of handrail and in the top of shoe rail to receive the square top or bottom of a baluster.

Plug – See *Rail Plug*.

Plumb – Perfectly straight in the vertical plane.

PTP – The abbreviation for Post-to-Post.

Post-to-Post – A balustrade system where handrail is cut and attached between square top newels.

Pythagorean Theorem – The theorem that the square of the hypotenuse of a right triangle is equal to the sum of the squares of the other two sides. ($A^2 + B^2 = C^2$)

Rail – The lineal moulding used as hand support in balustrade systems.

Rail Bolt – A two-ended threaded steel fastener with nut and washer that is used to join handrail to fittings, newels and/or walls. Coffman item #C-3001.

Rail-Bolt Fastener – A kit which includes a rail bolt and plugs. Coffman item #C-3302.

Rail-Bolt Wrench – A specially designed wrench to ease in the installation of rail bolts. Coffman item #C-3901.

Rail Bracket – See *Wall Rail Bracket*.

Rail Clearance – The minimum clearance required between the rail and any other object, such as a wall or landing tread nosing.

Rail Fitting – See *Fitting*.

Rail & Post Fastener – A kit including a bolt, washer and plugs for installing newels or for attaching rail to newels. Coffman item #C-3301.

Rail Plug – A round wood plug used to fill holes drilled in newels and rails, allowing screws or rail bolts to be used. Coffman item #C-3000.

Rail Projection – Projection of the handrail into the stairwell, measured from the wall to the far side of the rail.

Rail Termination – A method of finishing the balustrade as the rail reaches a wall. Rosettes and half newels are examples.

Rake – The angle of ascent, or slope, of a stairway. This is determined by the rise and run.

Rake Collar – A forged collar used on a slope to trim the baluster.

Rake Rail – Ascending handrail of a balustrade - follows the pitch or rise of the stair.

Return Nosing – A moulding used to trim the end of a tread on the open side of a stair.

Reversible Tread – A mitered return tread with return nosing applied to one side of a two-faced tread.

Right Hand Stair – A stair with balustrade on the right side from the bottom of the stair looking up.

Right Hand Tread – A mitered return tread with return nosing applied to the right side from the bottom of the stair looking up.

Rise – The vertical distance from the top of one tread to the top of the next tread.

Riser – The vertical finished component of a stair filling the space between the treads.

Riser Cap – An economic alternative to a full riser where carpet will be installed down the center of the stair.

Riser Core – The blocking material in the end of starting risers to form the radius and support the starting newel.

Rosette – A decorative and anchoring wall plate used to terminate handrail into a wall.

Rough Horse – *See Carriage.*

Rough Stringer – *See Carriage.*

Routed Stringer – Carriage/skirtboard with recessed cuts to receive and wedge treads and risers.

Run – The horizontal distance from the face of one riser to the face of the next riser.

S-Series Fitting – A rail fitting that will accommodate an offset in the balustrade center line without a break in the handrail.

Scotia Moulding – *See Cove Moulding.*

Shoe Moulding – A convex shaped moulding, usually used where the first riser meets the finished floor.

Shoe Rail – A plowed, lineal moulding designed to receive the bottom square of a baluster.

Skirtboard – A finished trim board used on either open or closed sides of the stair as a decorative accent.

Skirtboard Marking Jig – A tool used for marking a finished skirtboard for mitering the edge that will attach to the risers. This tool is usually made on the job site from scrap lumber.

Spacer – A length of 2 x 4 installed parallel to the stair rake between the rough wall and an inside carriage, eliminating the need to make sawtooth cuts in the finished wall materials.

Sphere Codes – Building codes that state that a sphere of a certain size cannot pass: (1) between balusters, or (2) through the triangle formed by the tread, riser and the bottom of shoe rail in a stair with shoe rail used on an open tread.

Spindle – *See Baluster.*

Spiral Stair – A stair where the treads form a circle around a center point as the stair ascends from one floor to the next.

Spring-Back – The expansion of the radius of curved rail after it is removed from the bending guides, due to the inherent tension.

Square Top Baluster – Balusters that have square (unturned) tops, usually installed with plowed rail or sub rail.

Stair Balustrade – *See Balustrade.*

Stair Body – All parts of a stair that are below the walking surface. It consists of treads, risers, skirtboard, landing tread, cove moulding, shoe moulding, tread brackets and the starting step.

Stair Gauge – *See Angle Gauge.*

Stair Width – The width of a stair measured either: (1) finished wall to finished wall, (2) between finished wall and the outside edge of the skirtboard, or (3) from the outside edge of the skirtboard to the outside edge of skirtboard.

Stairway – The entire set of steps comprising one or more flights of stairs.

Stairwell Opening – The width of a stairway plus ample room to apply all finished wall materials without infringing on the stair width code minimums.

Starting Easing – A straight rail fitting used to start an Over-the-Post system without the use of a starting step.

Starting End Cap – An economic alternative to a full starting step where carpet will be installed down the center of the stair.

Starting Newel – The vertical post used to start a balustrade system.

Starting Step – A decorative first step of a stair, generally designed with a tread and riser which lengthen the step beyond the width of the basic stair.

Straight Stair – A stairway with no turns or intermediate landings.

Stringer – *See Carriage.*

Subfloor Rise – The measurement taken from the top of the subfloor of the lower level to the top of the subfloor of the upper level. The total rise of a stair, measured before finish materials are applied.

Sub Rail – A lineal moulding, plowed top and bottom, to receive handrail on the top and square top balusters on the bottom.

Subriser – A carpet-grade riser used under riser caps where carpeting will be installed down the center of the stair.

Subtread – A carpet-grade tread used under tread caps where carpeting will be installed down the center of the stair.

Sure-Tite Newel Fastener – A kit which includes a large lag bolt, a washer, nut and plugs for use in installing newels. Coffman item #C-3008.

T-Shaped Stair – A stair with an intermediate landing that divides and continues upward with stairs on both the left and the right of the landing.

Take-Off – Material list of required stair components for a specific stair.

Tandem Cap – A rail fitting used where level rail passes over a pin top newel.

Tangent Point – The point at which a straight line touches a curve.

Tapered Top Baluster – *See Pin Top Baluster.*

Template – A paper marking pattern used to locate holes for the correct placement of balusters and newels in the bottom of starting fittings and in the top of the starting tread.

Total Rise – The total vertical distance from finish-floor to finish-floor.

Total Run – The total horizontal distance covered by the entire stairway.

Tread – The horizontal component of a stair on which one steps.

Tread Cap – An economic alternative to a full tread in a stair where carpet will be installed down the center of the stair.

Tread Bracket – A decorative piece mitered to the riser and fastened on the side of an open skirtboard.

Tread Nailing Jig – A tool made to slide over the front overhang of treads as a guide for nailing the treads into the narrow top edge of the risers. This is usually made on the job site from scrap lumber.

Tread Nosing – The rounded edge of a tread.

Tread Overhang – The portion of the tread which protrudes beyond the face of the riser. The width of the overhang is added to the tread run to obtain tread width.

Turnout – A curved rail fitting used as one option to start an Over-the-Post balustrade system.

U-Shaped Stair – A stair with a landing, or landings, that changes the direction of the stair 180 degrees.

Unit Rise – *See Rise.*

Unit Run – *See Run.*

Up Easing – A rail fitting which curves, permitting the handrail to change the slope of the rail system. Up easings are normally used at the top and bottom of Over-the-Post stair runs. Up easings are a component part of all starting fittings and goosenecks.

Vertical Volute – A volute that scrolls down from the rail rather than horizontally left or right.

Volute – A rail fitting that scrolls left or right used as one option to start an Over-the-Post balustrade system.

Wall Rail – Rail affixed to the wall, usually by means of mounting brackets. It may be the primary handrail for a closed stair or the supplementary handrail to a balustrade system.

Wall Rail Bracket – A metal bracket that is used to fasten wall rail to the wall. Coffman item #C-3002 and #C-3601.

Wedge – A tapered strip of wood driven and glued into a routed stringer to fasten treads and risers securely. Wedges also help prevent squeaks.

Well Hole – *See Stairwell Opening.*

Winder Stair – A stair that makes a directional change without the use of a platform.

Winder Tread – A nonrectangular tread used in combination to make directional changes in winder stairs.

Wonderail – An adjustable system of pre-assembled handrail, shoe rail and balusters.

Wood Plug – *See Rail Plug.*

Index

ACCESSORIES

Decorative brackets 2-9, 4-10
Forged 11-2 thru 11-4
Plugs 6-8 thru 6-10, 6-12, 7-11, 7-17
Rail 2-25
Rosettes 5-5, 7-17, 7-29, 10-8
Wall rail brackets 7-27 thru 7-30, 12-6

ADHESIVES

Balusters 8-7
Curved stairs 9-10, 9-11
Fittings 7-8, 7-18, 7-23, 7-25
Forged 11-1 thru 11-4
Newels 6-1, 8-8

BALCONY

Balusters 2-28
Balustrade 1-2, 5-6, 5-7
Center line 6-10, 6-11
Code requirements 2-2, 2-28
Fittings 2-22, 7-25
Height 2-2
Landing tread 4-17
Newels 2-11, 2-16, 2-19, 6-10
Rail attachment 7-3, 7-15, 8-15
Rail heights 2-2
Wonderail 10-1, 10-8

BALUSTERS

Code requirements 2-3, 2-27, 2-28
Cutting 8-4 thru 8-7
Defined 2-26, 8-1
Doweled 8-3
Drilling 8-3, 8-4, 8-6
Final installation 8-7 thru 8-9, 8-11 thru 8-15
Forged 11-1 thru 11-6
Hardware 8-3, 12-3
Installation 8-2, 8-3, 8-10
Length requirements 2-27
Marking 5-2, 5-3, 5-6, 5-7, 8-2 thru 8-4
Nailing 8-10, 8-12, 8-14, 8-20
Pin top 2-26, 8-11, 8-12
Spacing 2-3, 2-27, 2-28, 5-2, 5-3, 5-6, 5-7
Square top 2-26, 8-13 thru 8-20

BALUSTER FASTENING KIT (C-3201) 12-3

BALUSTRADES

Art Deco family 5-8
Assembly 8-7 thru 8-20
Balcony 1-2
Center line, standard 5-1, 5-2, 5-4

Center line, alternative 5-5
Closed 1-3, 1-4
Code requirements 2-3
Curved 9-1, 9-4, 9-16
Defined 2-1
Open 1-3, 1-4
Over-the-Post 8-8
Partial open 1-4
Post-to-Post 8-10
Rake 1-2
Shoe rail 2-24
Sub rail 2-25
Wonderail 10-1

BANDBOARD 2-5

BASE COLLAR 11-2 thru 11-4

BENDING MOULD 9-2, 9-4, 9-10, 9-12

BENDING RAIL 9-2, 9-5

BLOCKING 3-14, 6-11, 6-17

BRACKETS, DECORATIVE

Defined 2-9
Installed 4-10

BRACKETS, RAIL

(See Wall rail)

BUILDING CODES

Balcony 2-2, 2-28
Balusters 2-3, 2-27, 2-28
Balustrades 2-3
Code requirements 2-2
Design 3-2
Headroom 2-3, 3-2, 3-3
Rail clearance 2-4
Rail height 2-2, 2-14
Rail projection 2-4
Rise 2-2
Run 2-3
Sphere code 2-3, 10-1
Stair width 2-4, 3-2
Tread overhang 2-5
Wonderail 10-1

CARRIAGE

Angled stairs 3-12, 3-13
Attachment 3-11
Cutting 3-8
Defined 3-5
Dropping 3-7
Hanger board 3-11
Installing 3-9 thru 3-11
Kick board 3-8, 3-10
Layout 3-5, 3-6
Ledger board 3-8, 3-9
Length 3-5
Notched 3-11
Open side 3-10
Quantity 3-5
Stock 3-5

CODE (See Building code)

COVE MOULDING

Defined 2-8
Installed 2-8, 4-17
Starting steps 4-12

CURB WALL (See Knee wall)

CURVED RAIL

Balcony 9-16
Bending guide 9-6, 9-7, 9-16
Bending mould 9-2, 9-4, 9-10 thru 9-12
Bending rail 9-2, 9-5
Gluing 9-10 thru 9-12
Installation 9-7 thru 9-16
Layout 9-4, 9-5
Measuring 9-4
Preparation 9-11, 9-12
Radius, minimum 9-3, 9-16
Rake 9-2, 9-5
Spring-back 9-8, 9-16

DESIGN

Angle stairs 3-12, 3-13
Code requirements 3-2
Curved 1-5
Discussed 3-3, 3-4
Finish-floor to finish-floor 3-3
L-shaped stairs 1-5
Straight-run stairs 1-5
U-shaped stairs 1-5
Winder 1-5

FALSE TREADS

(See Tread caps)

FALSE RISERS

(See Riser caps)

FALSE STARTING STEPS

(See Starting caps)

FILLET 2-25, 8-14 thru 8-16, 8-20, 10-7

FITTINGS

Accessories 2-20
Angle changes 7-20 thru 7-23
Art Deco family 2-21, 5-8, 7-20
Attaching to rails 7-8 thru 7-11
Balcony turn 180° 7-25
Cap vs. no cap 2-21, 2-23
Combining 7-25, 7-26
Coped 7-20, 7-21
Cutting 7-4 thru 7-8, 12-1
Defined 2-20
Easings 7-4, 7-18, 7-19
Goosenecks 2-22, 7-12 thru 7-15
Intermediate turn 180° 7-26
Matching to rail profile 2-20
Newels 2-16 thru 2-19
Orientation 2-21
Post-to-Post 2-12, 7-15

Rail bolts 7-8 thru 7-11
S-Series 7-19
Specialty 7-20 thru 7-23
Square top balusters 8-17, 8-18

FORGED COLLECTION

Accessories 11-2 thru 11-4
Adhesives 11-2, 11-3
Adjustable collar 11-2, 11-4
Application tools 11-2
Baluster installation 11-3, 11-4
Base collar 11-2, 11-3
Epoxy 11-2, 11-3
Rake collar 11-2, 11-4
Trimming 11-2

GOOSENECK FITTINGS

Applications 2-23
Balcony 7-15
Cutting 7-8, 7-9, 12-1
Easings 7-4 thru 7-8
Installation 7-12 thru 7-14
One-rise vs. two-rise 2-22, 2-23
Post-to-Post 7-15

GLUE BLOCK 4-15

HANDRAIL (See Rail)

HANGER BOARD 3-11

HARDWARE

Rail Bolt (C-3001) 7-3, 7-8 thru 7-11, 10-8, 12-4
Wall Rail Bracket (C-3002) 6-12, 7-27, 7-28, 7-30
Sure-Tite Newel Fastener (C-3008) 6-6, 6-11, 12-2
Baluster Fasteners (C-3201, C-3203) 12-3
Wonderail (C-3210) 10-5, 10-6
Rail & Post Fastener (C-3301) 6-4, 6-6, 6-8 thru 6-10, 6-12, 6-18, 7-2, 10-8, 12-4
Rail-Bolt Fastener (C-3302) 7-3, 7-8 thru 7-11, 12-4
L-Bracket Post Fastener (C-3505) 6-11, 12-5
Heavy-Duty Wall Bracket (C-3601) 7-27, 7-28, 7-30, 12-6
Rail-Bolt Wrench (C-3901) 7-10, 7-11, 12-6

HEADROOM

Code requirements 2-3, 3-2
Figuring 3-3, 3-4

KNEE WALLS

Balusters 5-7, 8-11, 8-12, 8-19, 8-20
Closed stairs 1-3
Forged 11-4
Newels 6-18
Wonderail 10-7

L-BRACKET POST FASTENERS (C-3505) 6-11, 12-5

L-SHAPED STAIRS 1-5, 3-12, 3-13

LANDING 3-12, 3-13

LANDING TREAD

Balcony 4-17
Defined 2-8, 4-17
Installed 4-17

MOULDING

Cove moulding 2-8, 4-12, 4-17
Landing tread 2-8, 4-12, 4-17
Nosing 2-6
Shoe moulding 2-8, 4-17

NEWELS

Adjustable 2-13, 6-5
Art Deco family 5-8
Balcony 2-11, 2-16, 2-19, 6-10, 6-11
Blocking 6-17
Box-type 6-16, 6-17
Defined 2-10
Doweled vs. undoweled 2-12, 6-4 thru 6-6
Easings 2-16, 6-7
Half newels 6-12, 7-3, 7-16
Hardware 6-4, 6-6, 6-8 thru 6-18, 12-2, 12-3, 12-5
Heights 2-14, 2-15, 2-18, 6-3
Installing 6-2, 6-3, 6-8 thru 6-11
Intermediate 2-11, 2-14, 2-16, 2-19, 6-10, 6-16
Landing 2-11, 2-14, 2-16, 2-19
Layout 5-4, 5-5, 6-2, 6-6, 6-9, 6-10
Notched 5-4, 5-5, 6-7 thru 6-10, 6-13 thru 6-16
Over-the-Post 2-12, 2-15, 2-16, 2-19, 5-8
Pin 2-12
Placement 2-14, 2-16 thru 2-19
Post-to-Post 2-10 thru 2-12, 2-14, 2-15
S-Series 6-18
Starting 2-10, 2-12 thru 2-14, 2-16, 2-17, 4-13, 6-2, 6-3, 6-6 thru 6-9, 6-16
Turnouts 2-17, 6-2, 6-6
Volutes 2-17, 6-2, 6-6

RAKE COLLAR 11-2, 11-4

RISE

Code requirements 2-2
Total, figuring 3-3, 3-4
Unit 3-3, 3-4

RISER CAPS

Defined 2-9
Installed 4-18, 4-19
Subriser 4-18

RISERS

Code requirements 2-5
Defined 2-5
Installing 4-11
Mitered 4-11
Subriser 4-18

ROSETTES 7-3, 7-17, 7-29, 10-8

OVER-THE-POST (OTP)

Balustrade 8-8
Defined 1-1
Rails 7-4

PITCH BLOCK 7-4, 7-5

PLUGS

Newels 6-8 thru 6-10, 6-12, 6-17
Rails 7-11, 7-17

POST-TO-POST (PTP)

Balustrade 8-10
Defined 1-1
Rails 7-2

RAIL

Angle changes 7-20 thru 7-23
Attaching to newels 2-11, 7-2, 7-3, 8-10,
Balcony 2-19, 7-3, 7-15, 8-15, 9-16
Bending rail 9-2, 9-5
Clearance 2-4, 5-5
Drilling 8-4, 8-6
Hardware 7-2, 7-3, 7-8 thru 7-11, 12-4
Heights, code requirements 2-2, 2-18
Installation 8-8, 8-9
Measuring 2-24, 7-2
Projection 2-4
Plowed vs. unplowed 2-24
Plugs 7-11, 7-17
Rake rail 2-2, 2-18, 7-2, 7-3, 7-14, 9-5
Terminations 7-16, 7-17

RAIL BOLT (C-3001, C-3302)

Drilling 7-9
Installing 7-3, 7-10, 7-11, 10-8, 12-4
Marking 7-8, 7-9
Rail-Bolt Wrench (C-3901) 7-10, 7-11, 12-6

RAKE COLLAR 11-2, 11-4

RISE

Code requirements 2-2
Total, figuring 3-3, 3-4
Unit 3-3, 3-4

RISER CAPS

Defined 2-9
Installed 4-18, 4-19
Subriser 4-18

RISERS

Code requirements 2-5
Defined 2-5
Installing 4-11
Mitered 4-11
Subriser 4-18

ROSETTES 7-3, 7-17, 7-29, 10-8

ROUGH HORSE (See Carriage)

RUN

Code requirements 2-3
Total, figuring 3-3, 3-4
Unit 3-3, 3-4

SCOTIA (See Cove moulding)

SHOE MOULDING

Defined 2-8
Installed 4-17
Starting steps 4-12

SHOE RAIL 2-24, 2-25, 8-11

SKIRTBOARD

Brackets 2-9
Closed 2-4, 4-2 thru 4-5
Cutting 4-8, 4-9
Installing 4-4, 4-5, 4-9
Layout template 4-6, 4-7
Marking jig 4-8
Measuring 2-4
Mitered 2-5, 4-8 thru 4-10,
4-19
Open 2-4, 4-5, 4-8 thru 4-10

SPRING-BACK 9-8, 9-16

STAIR

Angle 3-12, 3-13
Balustrade 1-2
Body 1-2, 1-3, 2-2, 2-4 thru 2-9,
4-1
Box vs. site-built 1-6
Carriage 3-5
Construction 3-1
Closed 1-3, 1-4, 2-6, 10-7
Curved 1-5
L-shaped 1-3, 1-5, 3-12, 3-13
Layout 1-5, 3-3
Open 1-3, 1-4, 10-2
Platform (landing) 3-12, 3-13
Straight 1-5
T-shaped 1-5, 3-12
U-shaped 1-5, 3-12
Winder 1-5
Width 2-4

STAIRWELL

Code requirements 3-2
Opening 3-2, 3-3
Size of, figuring 3-2
Unit rise 3-3
Unit run 3-3

STARTING EASINGS

Balusters 2-27
Cutting 7-4, 7-5, 12-1
Installed 2-16, 6-3

STARTING STEPS

Attach starting newel 4-13,
6-4, 6-6
Bullnose 2-7, 6-1
Components 2-7, 4-12
Cutting 4-12
Discussed 2-7, 6-16
Measuring 2-7

STARTING STEP END CAPS

Components 2-9, 4-20
Defined 2-7
Installation 4-20
Reversible 4-20

STRAIGHT-RUN STAIRS

(See Stair)

STRINGERS

Face (See Skirtboard)
Rough (See Carriage)
Routed 1-6

SUB RAIL 2-25

SURE-TITE NEWEL

FASTENER (C-3008) 6-6, 6-11,
12-2

T-SHAPED STAIRS 1-5, 3-12,
3-13

TAKE-OFF 2-1, 2-4

TAPERED TOP BALUSTERS

(See Pin top)

TEMPLATE

Fittings 6-2

TONGUE AND GROOVE 9-2

TREAD CAPS

Defined 2-9
Installed 4-18, 4-19
Reversible 4-19
Subtreads 4-18

TREADS

Closed stair 2-6, 4-14
Code requirements 2-5
Defined 2-5
Double mitered return 2-6, 4-16
Glue block 4-15
Installing 4-14, 4-15
Measuring 2-6
Mitered return 2-6, 4-16
Nailing jig 4-15
Nosing 2-6, 4-18
Open stair 2-6
Overhang 2-3, 2-5
Plain 2-6
Return nosing 2-6, 4-16
Subtread 4-18

TURNOUTS

Balusters 2-27
Cutting 7-4, 7-5, 12-1
Installed 2-17, 6-3
Newels 6-2

U-SHAPED STAIRS 1-5, 3-12,
3-13

VOLUTES

Ascending 2-17, 7-24
Balusters 2-27
Cutting 7-4, 7-5, 12-1
Installed 2-17, 6-3
Newels 6-1
Vertical 2-17, 7-20

WALL RAIL

Brackets 7-27 thru 7-30, 12-6
Discussed 7-27
Fittings 7-29, 7-30
Hardware 7-27, 7-28, 12-6
Options available 7-27, 7-29,
7-30
Projection 2-4, 7-29

WINDER TREADS 1-5

WM Coffman®

STAIR BUILDING GUIDE

This instruction manual is the first comprehensive visual book on stair building. It contains over 475 black and white photographs with detailed instructions, illustrations and reference tables.

WMCoffman, the creator of this manual, is one of America's oldest millwork companies. They have been making quality hardwood stair parts since 1874.

*Your stair questions are answered in this easy step-by-step guide by Coffman...
"America's Stair Maker."*

Proudly Supplied By

